

2J Antennas



Connecting the World
ANTENNA MANUFACTURER
CATALOGUE



Smart homes
Traffic flow Building management Security
Tracking 5G ready
Transportation Aviation
Banking Monitoring Controlling
Telematics
Digital signage
Industrial ISM
Retail Metering
Logistics Energy
Measurement WiFi
Navigation M2M
Automotive
Computers
4G LTE
IoT mark
Modems & Router
Communications

WWW.2J-ANTENNAS.COM

Company Overview

As a leading company in the antenna sector, we would like to welcome you to our world of solutions.

Since the inception of 2J Antennas in 2002, the company became a global supplier of antenna solutions that aims to deliver innovative technologies for the connected world. In addition to our classic range of antennas, our New Catalog features a series of high-quality products with cutting-edge technologies to meet the rapidly evolving wireless industry catering to 5G, 4G (LTE), 3G, 2G, WiFi, ISM, IoT solutions, Iridium communications, GPS/GLONASS/BeiDou frequencies and more.

With a focus on Automotive, Navigation, IoT, Marine, Telematic, Automation, M2M and other markets, we employ a customized solution for the development and delivery of every application requirement. With our in-house design, R&D and manufacturing, our customers' projects will benefit from dedicated engineering teams, rapid prototyping and a step-by-step walkthrough certification process. With RF development locations in Slovakia and in the UK, our team has developed a reputation for engineering excellence and self-sufficiency. In 2015, 2J expanded its reach to the American market with a new engineering and sales support office in San Diego, California.



2J SVK (HQ)

2J Antennas, s.r.o.

2J is a worldwide supplier of ultra-high-efficiency, premium quality antennas.

With a global distribution network, we are able to provide an end-to-end solution, covering markets including Automotive, IoT, Marine, Telematic, Automation, M2M and more.



2J USA

2J Antennas USA, Corp.

Located in the epicenter of the wireless industry area, 2J Antennas' San Diego California office has invested major resources into the implementation of RF/Antenna equipment. The branch provides local customer service, technical support, sales, logistics as well as engineering services.



2J UK

2J Antennas UK, Ltd.

In 2008 2J Antennas expanded into the United Kingdom forming 2J UK branch with a new engineering facility and regional sales support office. Our UK facility is the go-to place for our clients, whether it's for a quick coffee, sales support or use of our CTIA approved 3D Starlab anechoic chamber, network analysers, or other RF equipment.

Smart homes IoT market Measurement WiFi
 Traffic flow Building management Aviation
 Tracking 5G ready Navigation
 Transportation Security Lights Automotive
 Banking Monitoring Controlling Computers Temperature monitoring
 Telematics Industrial M2M Modems & Routers 4G LTE
 Digital signage Retail Metering Energy Production Communications
 Resources ISM Logistics Energy

We utilize a large selection of modern engineering tools including network analyzers, anechoic chambers, simulation software, 3D rapid prototyping printers and many more. These tools help reduce design phases, enabling the engineering team to react promptly and expand efficiently to satisfy all customers' needs.



2J Antennas is proud to support our fragile environment by manufacturing our products with non-hazardous materials making us fully RoHS, REACH, IATF 16949:2016, ISO 9001:2015 and ISO 14001:2015 compliant. In addition, selected antennas are IP67, IP69K, IK-09 and CE certified. Plastic injection, SMD pick and place, product assembly and quality control are all carried out in-house allowing flexibility in manufacturing and competitive product prices.

 IATF 16949:2009 Automotive standards	 EN ISO 14001:2004 Environmental	 EN ISO 9001:2008 Quality management system	 RoHS COMPLIANT	 REACH COMPLIANCE	IP67 Water Resistance	IP69K Hot Water Pressure	IK09 Heavy Duty	UL94-V0 Fire Resistance	EN50155 Railway certificates ESD - CE Vibration, shock Cooling test...
---	--	---	-----------------------	-------------------------	--------------------------	-----------------------------	--------------------	----------------------------	--



Table of Contents



- 01 Company Overview**
- 03 Table of Contents**
- 07 Services**
- 13 Measurement and Tolerances & Connector Orientation Guideline**

16 Single External Antennas

- 17 Connector Mount**
 - 17 5G NR/4G LTE/FirstNet/CBRS/LPWA/3G/2G
 - 18 4G LTE/FirstNet/LPWA/NB/IoT/3G/2G
 - 23 3G/2G/CELLULAR
 - 24 GPS/GLONASS/BEIDOU/QZSS/Galileo/L1
 - 25 2.4GHz/WiFi/LPWA/BT/ISM
 - 27 5.0GHz/WiFi/ISM
 - 27 2.4-5.0GHz/WiFi/LPWA/BT/ISM
 - 30 433MHz/LPWA/RFID/ZigBee/ISM
 - 33 868MHz/Sigfox/LoRa/LPWA/RFID/ZigBee/ISM
 - 35 915MHz/Sigfox/LoRa/LPWA/RFID/ZigBee/ISM
 - 37 380-470MHz/LPWA/TETRA/UHF
 - 37 470MHz/LPWA/Sigfox/LoRa
 - 38 169MHz/ERMES/VHF
 - 38 IRIDIUM
 - 39 DECAWAVE
 - 39 FM
 - 39 FM/DAB
 - 40 FM/DAB Splitter / Accessories
- 41 Screw Mount**
 - 41 4G LTE/FirstNet/LPWA/NB/IoT/3G/2G
 - 43 3G/2G/CELLULAR
 - 45 GPS/GLONASS/QZSS/Galileo/L1
 - 46 GPS/QZSS/Galileo/L1/IRIDIUM
 - 46 GPS/GLONASS/BEIDOU/QZSS/Galileo/L1/L2/RTK
 - 47 2.4GHz/WiFi/LPWA/BT/ISM
 - 47 2.4-5.0GHz/WiFi/LPWA/BT/ISM
 - 49 433MHz/LPWA/RFID/ZigBee/ISM
 - 50 868MHz/Sigfox/LoRa/LPWA/RFID/ZigBee/ISM
 - 51 915MHz/Sigfox/LoRa/LPWA/RFID/ZigBee/ISM
 - 53 380-470MHz/LPWA/TETRA/UHF
 - 54 IRIDIUM
 - 55 HDTV-DVBT
- 56 Adhesive Mount**
 - 56 5G NR/4G LTE/FirstNet/CBRS/LPWA/3G/2G
 - 56 4G LTE/FirstNet/LPWA/NB/IoT/3G/2G
 - 58 3G/2G/CELLULAR
 - 59 2.4-5.0GHz/WiFi/LPWA/BT/ISM
 - 60 433MHz/LPWA/RFID/ZigBee/ISM
 - 61 868MHz/Sigfox/LoRa/LPWA/RFID/ZigBee/ISM
 - 62 915MHz/Sigfox/LoRa/LPWA/RFID/ZigBee/ISM
 - 62 380-470MHz/LPWA/TETRA/UHF
 - 63 IRIDIUM

- 64 Magnetic Mount**
 - 64 5G NR/4G LTE/FirstNet/CBRS/LPWA/3G/2G
 - 64 4G LTE/FirstNet/LPWA/NB/IoT/3G/2G
 - 66 3G/2G/CELLULAR
 - 67 GPS/QZSS/Galileo/L1/IRIDIUM
 - 68 GPS/GLONASS/BEIDOU/QZSS/Galileo/L1/L2/RTK
 - 68 2.4GHz/WiFi/LPWA/BT/ISM
 - 69 433MHz/LPWA/RFID/ZigBee/ISM
 - 70 868MHz/Sigfox/LoRa/LPWA/RFID/ZigBee/ISM
 - 70 915MHz/Sigfox/LoRa/LPWA/RFID/ZigBee/ISM
 - 71 IRIDIUM
 - 71 HDTV-DVBT
- 72 Magnetic/Adhesive Mount**
 - 72 4G LTE/FirstNet/LPWA/NB/IoT/3G/2G
 - 72 3G/2G/CELLULAR
 - 72 GPS/QZSS/Galileo/L1
 - 73 GPS/GLONASS/QZSS/Galileo/L1
 - 74 GPS/GLONASS/BEIDOU/QZSS/Galileo/L1
 - 74 2.4-5.0GHz/WiFi/LPWA/BT/ISM
- 75 Velcro/Adhesive Mount**
 - 75 4G LTE/FirstNet/LPWA/NB/IoT/3G/2G
 - 75 2.4-5.0GHz/WiFi/LPWA/BT/ISM
- 76 Wall Mount**
 - 76 4G LTE/FirstNet/LPWA/NB/IoT/3G/2G
 - 77 2.4-5.0GHz/WiFi/LPWA/BT/ISM
 - 77 433MHz/LPWA/RFID/ZigBee/ISM
 - 78 868MHz/Sigfox/LoRa/LPWA/RFID/ZigBee/ISM
 - 78 915MHz/Sigfox/LoRa/LPWA/RFID/ZigBee/ISM
- 79 Wall/Adhesive Mount**
 - 79 433MHz/LPWA/RFID/ZigBee/ISM
 - 79 380-470MHz/LPWA/TETRA/UHF
- 79 Pole Mount**
 - 79 2.4-5.0GHz/WiFi/LPWA/BT/ISM
- 80 Pole/Screw Mount**
 - 80 GPS/GLONASS/QZSS/Galileo/L1
 - 80 IRIDIUM



81 Combination External Antennas

82 Screw Mount

82 2-in-1

- 82 2x 4GLTE/FirstNet/LPWA/NB/IoT/3G/2G
- 85 4GLTE/FirstNet/LPWA/NB/IoT/3G/2G & GPS/QZSS/Galileo/L1
- 85 4GLTE/FirstNet/LPWA/NB/IoT/3G/2G & GPS/GLONASS/QZSS/Galileo/L1
- 89 4GLTE/FirstNet/LPWA/NB/IoT/3G/2G & 2.4-5.0GHz/WiFi/LPWA/BT/ISM
- 90 3G/2G/CELLULAR & GPS/GLONASS/QZSS/Galileo/L1
- 93 3G/2G/CELLULAR & 2.4-5.0GHz/WiFi/LPWA/BT/ISM
- 93 GPS/QZSS/Galileo/L1 & 2.4-5.0GHz/WiFi/LPWA/BT/ISM
- 94 GPS/GLONASS/QZSS/Galileo/L1 & 433MHz/LPWA/RFID/ZigBee/ISM
- 95 GPS/GLONASS/QZSS/Galileo/L1 & 868MHz/Sigfox/LoRa/LPWA/RFID/ZigBee/ISM
- 95 GPS/GLONASS/QZSS/Galileo/L1 & 915MHz/Sigfox/LoRa/LPWA/RFID/ZigBee/ISM
- 96 GPS/GLONASS/QZSS/Galileo/L1 & 380-470MHz/LPWA/TETRA/UHF
- 97 GPS/GLONASS/QZSS/Galileo/L1 & 169MHz/ERMES/VHF
- 97 GPS/GLONASS/QZSS/Galileo/L1 & ORBCOMM
- 98 GPS/GLONASS/QZSS/Galileo/L1 & FM
- 98 GPS/GLONASS/QZSS/Galileo/L1 & IRIDIUM
- 100 2x 2.4-5.0GHz/WiFi/LPWA/BT/ISM

102 3-in-1

- 102 2x 4GLTE/FirstNet/LPWA/NB/IoT/3G/2G & GPS/GLONASS/QZSS/Galileo/L1
- 104 2x 4GLTE/FirstNet/LPWA/NB/IoT/3G/2G & 2.4-5.0GHz/WiFi/LPWA/BT/ISM
- 105 4GLTE/FirstNet/LPWA/NB/IoT/3G/2G & GPS/GLONASS/QZSS/Galileo/L1 & 2.4-5.0GHz/WiFi/LPWA/BT/ISM
- 108 4GLTE/FirstNet/LPWA/NB/IoT/3G/2G & GPS/GLONASS/BEIDOU/QZSS/Galileo/L1 & 2.4-5.0GHz/WiFi/LPWA/BT/ISM
- 110 4GLTE/FirstNet/LPWA/NB/IoT/3G/2G & GPS/GLONASS/QZSS/Galileo/L1 & IRIDIUM
- 110 3G/2G/CELLULAR & GPS/GLONASS/QZSS/Galileo/L1 & 2.4GHz/WiFi/LPWA/BT/ISM
- 111 3G/2G/CELLULAR & GPS/GLONASS/QZSS/Galileo/L1 & 380-470MHz/LPWA/TETRA/UHF

- 112 3G/2G/CELLULAR & GPS/GLONASS/QZSS/Galileo/L1 & IRIDIUM
- 112 3G/2G/CELLULAR & GPS/GLONASS/QZSS/Galileo/L1 & AM/FM
- 113 3G/2G/CELLULAR & GPS/GLONASS/QZSS/Galileo/L1 & FM
- 113 GPS/GLONASS/QZSS/Galileo/L1 & 2.4GHz/WiFi/LPWA/BT/ISM & 433MHz/LPWA/RFID/ZigBee/ISM

114 4-in-1

- 114 4x 5GNR/4GLTE/FirstNet/CBRS/LPWA/3G/2G
- 115 4x 4GLTE/FirstNet/LPWA/NB/IoT/3G/2G
- 116 2x 4GLTE/FirstNet/LPWA/NB/IoT/3G/2G & GPS/GLONASS/QZSS/Galileo/L1 & 2.4GHz/WiFi/LPWA/BT/ISM
- 117 2x 4GLTE/FirstNet/LPWA/NB/IoT/3G/2G & 2x 2.4-5.0GHz/WiFi/LPWA/BT/ISM
- 118 3G/2G/CELLULAR & GPS/GLONASS/QZSS/Galileo/L1 & 2.4GHz/WiFi/LPWA/BT/ISM & IRIDIUM
- 119 3G/2G/CELLULAR & GPS/GLONASS/QZSS/Galileo/L1 & 2.4-5.0GHz/WiFi/LPWA/BT/ISM & AM/FM
- 120 4x 2.4-5.0GHz/WiFi/LPWA/BT/ISM

121 5-in-1

- 121 4x 5GNR/4GLTE/FirstNet/CBRS/LPWA/3G/2G & GPS/GLONASS/QZSS/Galileo/L1
- 122 2x 5GNR/4GLTE/FirstNet/CBRS/LPWA/3G/2G & 2x 2.4-5.0GHz/WiFi/LPWA/BT/ISM & GPS/GLONASS/QZSS/Galileo/L1
- 123 4x 4GLTE/FirstNet/LPWA/NB/IoT/3G/2G & GPS/GLONASS/QZSS/Galileo/L1
- 124 2x 4GLTE/FirstNet/LPWA/NB/IoT/3G/2G & 2x 2.4-5.0GHz/WiFi/LPWA/BT/ISM & GPS/GLONASS/QZSS/Galileo/L1
- 127 2x 4GLTE/FirstNet/LPWA/NB/IoT/3G/2G & GPS/GLONASS/QZSS/Galileo/L1 & 2.4-5.0GHz/WiFi/LPWA/BT/ISM & 868MHz/Sigfox/LoRa/LPWA/RFID/ZigBee/ISM
- 128 2x 4GLTE/FirstNet/LPWA/NB/IoT/3G/2G & GPS/GLONASS/QZSS/Galileo/L1 & 2.4-5.0GHz/WiFi/LPWA/BT/ISM & 915MHz/Sigfox/LoRa/LPWA/RFID/ZigBee/ISM

129 Adhesive Mount

129 2-in-1

- 129 2x 5GNR/4GLTE/FirstNet/CBRS/LPWA/3G/2G
- 129 5GNR/4GLTE/FirstNet/CBRS/LPWA/3G/2G & GPS/GLONASS/QZSS/Galileo/L1
- 130 2x 4GLTE/FirstNet/LPWA/NB/IoT/3G/2G
- 131 4GLTE/FirstNet/LPWA/NB/IoT/3G/2G & GPS/GLONASS/QZSS/Galileo/L1
- 133 4GLTE/FirstNet/LPWA/NB/IoT/3G/2G & GPS/GLONASS/BEIDOU/QZSS/Galileo/L1
- 134 4GLTE/FirstNet/LPWA/NB/IoT/3G/2G & 2.4-5.0GHz/WiFi/LPWA/BT/ISM
- 135 3G/2G/CELLULAR & GPS/QZSS/Galileo/L1
- 135 3G/2G/CELLULAR & GPS/GLONASS/QZSS/Galileo/L1
- 136 3G/2G/CELLULAR & 2.4-5.0GHz/WiFi/LPWA/BT/ISM
- 136 GPS/GLONASS/QZSS/Galileo/L1 & IRIDIUM
- 137 2x 2.4-5.0GHz/WiFi/LPWA/BT/ISM

138 3-in-1

- 138 2x 5GNR/4GLTE/FirstNet/CBRS/LPWA/3G/2G & GPS/GLONASS/QZSS/Galileo/L1
- 138 2x 4GLTE/FirstNet/LPWA/NB/IoT/3G/2G & GPS/GLONASS/QZSS/Galileo/L1
- 139 2x 4GLTE/FirstNet/LPWA/NB/IoT/3G/2G & GPS/GLONASS/BEIDOU/QZSS/Galileo/L1
- 139 4GLTE/FirstNet/LPWA/NB/IoT/3G/2G & GPS/GLONASS/QZSS/Galileo/L1 & 2.4-5.0GHz/WiFi/LPWA/BT/ISM
- 140 4GLTE/FirstNet/LPWA/NB/IoT/3G/2G & GPS/GLONASS/BEIDOU/QZSS/Galileo/L1 & 2.4-5.0GHz/WiFi/LPWA/BT/ISM

141 4-in-1

- 141 2x 4GLTE/FirstNet/LPWA/NB/IoT/3G/2G & GPS/GLONASS/BEIDOU/QZSS/Galileo/L1 & 2.4-5.0GHz/WiFi/LPWA/BT/ISM
- 142 2x 4GLTE/FirstNet/LPWA/NB/IoT/3G/2G & 2x 2.4-5.0GHz/WiFi/LPWA/BT/ISM

144 5-in-1

- 144 2x 4GLTE/FirstNet/LPWA/NB/IoT/3G/2G & 2x 2.4-5.0GHz/WiFi/LPWA/BT/ISM & GPS/GLONASS/BEIDOU/QZSS/Galileo/L1

145 Magnetic Mount

145 2-in-1

- 145 2x 4GLTE/FirstNet/LPWA/NB/IoT/3G/2G
- 146 4GLTE/FirstNet/LPWA/NB/IoT/3G/2G & GPS/GLONASS/QZSS/Galileo/L1
- 148 4GLTE/FirstNet/LPWA/NB/IoT/3G/2G & 2.4-5.0GHz/WiFi/LPWA/BT/ISM

- 149 GPS/GLONASS/QZSS/Galileo/L1 & 433MHz/LPWA/RFID/ZigBee/ISM
- 149 GPS/GLONASS/QZSS/Galileo/L1 & 915MHz/Sigfox/LoRa/LPWA/RFID/ZigBee/ISM
- 150 GPS/GLONASS/QZSS/Galileo/L1 & 169MHz/ERMES/VHF
- 150 GPS/GLONASS/QZSS/Galileo/L1 & IRIDIUM
- 151 GPS/GLONASS/QZSS/Galileo/L1 & ORBCOMM

152 3-in-1

- 152 2x 4GLTE/FirstNet/LPWA/NB/IoT/3G/2G & GPS/GLONASS/QZSS/Galileo/L1
- 153 4GLTE/FirstNet/LPWA/NB/IoT/3G/2G & GPS/GLONASS/QZSS/Galileo/L1 & 2.4-5.0GHz/WiFi/LPWA/BT/ISM
- 154 3G/2G/CELLULAR & GPS/GLONASS/QZSS/Galileo/L1 & IRIDIUM
- 155 GPS/GLONASS/QZSS/Galileo/L1 & 2.4GHz/WiFi/LPWA/BT/ISM & 433MHz/LPWA/RFID/ZigBee/ISM

156 Magnetic/Adhesive Mount

156 2-in-1

- 156 2x 4GLTE/FirstNet/LPWA/NB/IoT/3G/2G
- 156 3G/2G/CELLULAR & GPS/GLONASS/QZSS/Galileo/L1

158 Pole Mount

158 2-in-1

- 158 2x 4GLTE/FirstNet/LPWA/NB/IoT/3G/2G

159 4-in-1

- 159 2x 4GLTE/FirstNet/LPWA/NB/IoT/3G/2G & 2x 2.4-5.0GHz/WiFi/LPWA/BT/ISM

160 5-in-1

- 160 2x 4GLTE/FirstNet/LPWA/NB/IoT/3G/2G & 2x 2.4-5.0GHz/WiFi/LPWA/BT/ISM & GPS/GLONASS/QZSS/Galileo/L1

161 Pole/Screw Mount

161 2-in-1

- 161 GPS/GLONASS/QZSS/Galileo/L1 & AIS
- 161 GPS/GLONASS/QZSS/Galileo/L1 & 380-470MHz/LPWA/TETRA/UHF

162 Single Internal Antennas

- 164 Adhesive Mount Flexible**
 - 164 4GLTE/FirstNet/LPWA/NB/IoT/3G/2G
 - 165 3G/2G/CELLULAR
 - 165 2.4-5.0GHz/WiFi/LPWA/BT/ISM
 - 166 868MHz/Sigfox/LoRa/LPWA/RFID/ZigBee/ISM
 - 167 915MHz/Sigfox/LoRa/LPWA/RFID/ZigBee/ISM
 - 167 868-915MHz/Sigfox/LoRa/LPWA/RFID/ZigBee/ISM
- 168 Adhesive Mount Rigid**
 - 168 4GLTE/FirstNet/LPWA/NB/IoT/3G/2G
 - 169 3G/2G/CELLULAR
 - 170 2.4-5.0GHz/WiFi/LPWA/BT/ISM
 - 170 433MHz/LPWA/RFID/ZigBee/ISM
 - 171 868MHz/Sigfox/LoRa/LPWA/RFID/ZigBee/ISM
 - 171 915MHz/Sigfox/LoRa/LPWA/RFID/ZigBee/ISM
- 172 Surface Mount Ceramic**
 - 172 4GLTE/FirstNet/LPWA/NB/IoT/3G/2G
 - 172 GPS/GLONASS/QZSS/Galileo/L1
 - 173 GPS/GLONASS/BEIDOU/QZSS/Galileo/L1
 - 174 2.4GHz/WiFi/LPWA/BT/ISM
 - 175 5.0GHz/WiFi/ISM
 - 176 2.4-5.0GHz/WiFi/LPWA/BT/ISM
 - 177 433MHz/LPWA/RFID/ZigBee/ISM
 - 177 868MHz/Sigfox/LoRa/LPWA/RFID/ZigBee/ISM
 - 178 915MHz/Sigfox/LoRa/LPWA/RFID/ZigBee/ISM
- 179 Surface Mount Fiberglass**
 - 179 5GNR/4GLTE/FirstNet/CBRS/LPWA/3G/2G
 - 179 4GLTE/FirstNet/LPWA/NB/IoT/3G/2G
 - 179 3G/2G/CELLULAR
 - 180 169MHz/ERMES/VHF
- 181 Thru-Hole Mount Ceramic**
 - 181 GPS/QZSS/Galileo/L1
 - 181 GPS/GLONASS/QZSS/Galileo/L1
 - 182 GPS/GLONASS/BEIDOU/QZSS/Galileo/L1
 - 183 GPS/QZSS/Galileo/L1/IRIDIUM
 - 184 868MHz/Sigfox/LoRa/LPWA/RFID/ZigBee/ISM
 - 184 IRIDIUM
- 185 Snap-in Mount Module**
 - 185 GPS/QZSS/Galileo/L1
 - 187 GPS/GLONASS/QZSS/Galileo/L1
- 190 Screw Mount Module**
 - 190 GPS/QZSS/Galileo/L1/IRIDIUM
 - 190 IRIDIUM

192 Combination Internal Antennas

- 192 Adhesive Mount Flexible**
- 192 2-in-1**
 - 192 2x 2.4-5.0GHz/WiFi/LPWA/BT/ISM
- 193 Screw Mount Module**
- 193 2-in-1**
 - 193 GPS/GLONASS/QZSS/Galileo/L1 & IRIDIUM

194 Development Kits

- 195 Thru-Hole Mount Ceramic**
 - 195 GPS/QZSS/Galileo/L1
 - 195 GPS/GLONASS/QZSS/Galileo/L1
 - 196 GPS/GLONASS/BEIDOU/QZSS/Galileo/L1
 - 197 GPS/QZSS/Galileo/L1/IRIDIUM
 - 198 IRIDIUM

199 Development Boards

- 199 Connector Mount**
 - 199 4GLTE/FirstNet/LPWA/NB/IoT/3G/2G
 - 199 3G/2G/CELLULAR
 - 199 GPS/GLONASS/BEIDOU/QZSS/Galileo/L1
 - 200 2.4-5.0GHz/WiFi/LPWA/BT/ISM
 - 200 380-470MHz/LPWA/TETRA/UHF, 433MHz/LPWA/RFID/ZigBee/ISM, 169MHz/ERMES/VHF

201 Mounting Brackets

- 202 Screw Mount**
- 203 Magnetic Mount**
- 204 Magnetic/Adhesive Mount**
- 204 Wall Mount**
- 207 Pole Mount**

210 Cable Assemblies & Connectors example

211 Notes

Services

Research & Development

We are dedicated to providing an end-to-end manufacturing process.

Our team of engineers brings to their tasks a wide range of expertise and diverse perspectives in solving technical problems across the entire product and service spectrum.

Our engineers excel in the following fields:

- RF
- Antennas design & development
- Mechanics
- Quality
- Certification
- Molding

Three types of R&D

The R&D team is focused on three categories:

Future antennas

We maintain a deep insight into all the future requirements & specifications that are key to our technological growth in developing antennas and related systems.

Integration

We offer support and design input to successfully integrate a variety of emerging technologies in any product during the design phase. To date, 2J Antennas has integrated more than 500 types of antennas in various devices. Integrating custom antenna systems requested by our customers is driven by our highly experienced and innovative engineering team.

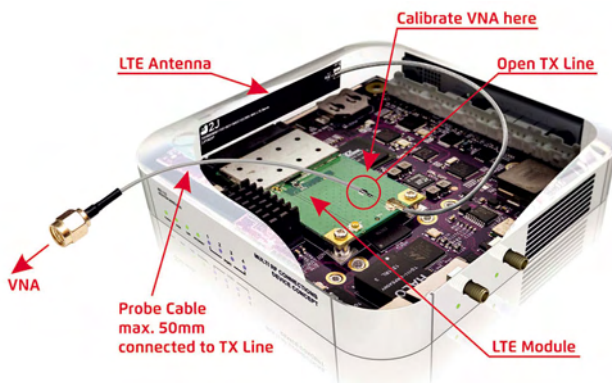

Custom antennas

Our dedicated and distinguished team of experts focus on developing and integrating antennas based on the customer's unique specifications and applications. We are prepared to meet the high level and complex demands for IOT, big data, cloud computing, and autonomous systems.

All our development is carried out using ultra-sophisticated equipment, ensuring the highest quality and reliability in standard and custom products. Below we have listed some of the equipment we use:

3D Anechoic Chamber

- Engineered to achieve exceptional results required to test low-noise products, 2J Antennas provides high-performance Satimo Anechoic Chambers located in Slovakia, UK and USA.
- Anechoic Chambers are capable of performing both active and passive testing with a capacity of up to 6 GHz.
- With its high capacity, it produces precise and error-free results in the shortest possible time.

RF Equipment

With a wide variety of equipment, we are able to better integrate, measure and manufacture a variety of antennas. Some of our equipment includes but is not limited to:

- Power sensors
- Network analyzers
- Spectrum analyzers
- Radio communication testers
- Power amplifier
- Low noise amplifier
- Horn antennas

3D Printing

Rapid prototyping allows for designing, implementing and testing new fixtures in record time. It minimizes troubleshooting and redesign efforts. Engineers can produce antenna housings more accurately and more rapidly. This has helped speed up a products' life cycle through the design, testing, and manufacturing process.

Various shapes of housings can be designed and tested at a minimal cost, allocating more time for errors analysis and minimizing the risks of future mistakes.

Equipment brands - Makerbot and Prusa

CAD and Simulation Tools

To improve the performance and range, several antenna designs are tested in 2D and 3D simulations prior to prototyping. Schematics and Gerber files are produced during the design phase.

Quick Turn Prototype

With the availability of various tools such as the 3D printers and other multiple manufacturing capabilities, the development timeline of a project can be drastically reduced allowing for a multitude of variables and designed to be completed and tested.

What can we prototype?

- Based on the implementation requirements, we can prototype every aspect of the antenna.
- For outside and external use, the complete housing and mounting fixture can be 3D printed and tested.
- Rigid PCB antenna can be manufactured and tested in various configurations.
- For flexible applications and requirements, we can provide rapid prototyping of flexible PCB adhesive antennas.
- The cable assembly and connector type can be tested prior to manufacturing release.

End-to-end

We implement a wide range of services that help every customer bring a product to market with little to no effort by providing a true end-to-end process.

Customized RF Antenna Design

**From Prototype to Product:
Ensuring Your Solution is Feasible and Viable**

We custom design antennas and provide integration support to meet the continuous increase in demand for high-quality network services.

Our team utilizes a wide range of technologies to meet customization demands, address manufacturing constraints, and ensure optimal design.

RF Antenna Integration

2J Antennas offers antenna tuning and integration services. They include product integration, certified antenna testing, performance measurements, RF radiation pattern mapping, environmental testing, shock and drop tests, water and dust durability immersion.

Noise Debugging

Any unwanted signal can be flagged as noise. Noise is a key issue in wireless communication and has a large impact on user experience. We offer specialized and sophisticated techniques and services to identify, analyze, and propose suitable solutions to issues caused by noise or other anomalies.

Design Feasibility

We provide a validated process, consulting services and detailed feasibility reports that look at how well the design delivers to requirements, objectives, and goals. Using rapid prototyping and 2D/3D simulations, an in-depth study is conducted to test parts of the design and ensure that all of the project stages are successful.

RF Antenna Testing Services

At 2J Antennas, we provide an end-to-end RF antenna testing service.

With our technical expertise, project management, and certification testing capabilities, we will assist in meeting the Global Certification Forum (GCF) and PCS Type Certification Review Board (PTCRB) requirements for any RF device.

Pre-PTCRB

Before introducing equipment to the market, any cellular device needs to comply with certain certifications & standards. Without this certification, devices may not be allowed to operate in North American networks. To get access to these markets, PTCRB has introduced a set of certification requirements. We provide a risk-free platform by performing thorough testing and providing detailed feasibility reports, shortcomings and roadblocks that might contribute to certification failure.

Devices can successfully be brought to market faster, without any further problems or extra costs.

Why should you consider this service from 2J Antennas?

- **Global Reach**
-Testing and certification in most markets
- **Pre-certification Testing**
-Identification of potential non-compliances
- **Tailored Testing - Solutions**
-Enhanced process efficiency and streamlined testing cycles
- **Rapid and Responsive**
-Flexible work schedules that help to meet even the tightest deadlines launching a device to the market

Passive Antenna Parameters

We will provide the required parameters to qualify and quantify any antenna, once they are integrated into a device:

- Impedance
- VSWR (Voltage Standing Wave Ratio)
- Return loss
- Efficiency
- Peak/Gain
- Average Gain
- 2D radiation patterns
- 3D radiation patterns

At 2J Antennas, we follow strict procedures to make sure that post-integration issues don't arise and that functionalities of both the device and antenna remain up to standards.

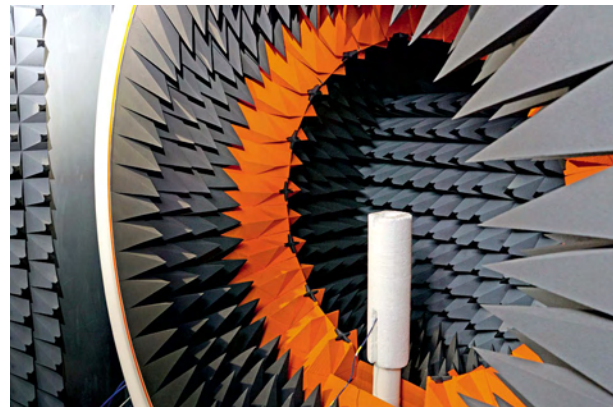

Total Radiated Power TRP

TRP gives us the power radiated by an antenna when it is connected to a transmitter. These measurements are available for equipment of various technologies: 4G LTE, 3G, WCDMA, GSM, and HSDPA.

Total Isotropic Sensitivity TIS

The TIS parameter is a key value as it is dependent on the antenna efficiency, the receiver sensitivity, self-interference.

Radiated Spurious Emission RSE

RSE are emissions at a frequency, or frequencies which are outside the necessary bandwidth. Spurious emissions include harmonic, parasitic, intermodulation and frequency conversion products but exclude out-of-band emissions. Our RSE reduces the spurious in order to not affect the other devices around.

Conducted Power and Sensitivity

In some cases, degradation can occur. Sensitivity and conducting power are some of the main parameters in wireless communication devices. We provide the tools to analyze and identify the issues and the root causes of any failure that could impact the PTCRB certification process.





Approval Testing

Full Market Access Solutions.

We offer full market access solutions including pre-compliance testing, product testing, documentation services, and product certification.

Constantly updated market requirements force wireless product manufacturers to adhere to regulatory changes and demanding testing procedures. Multiple certifications are necessary for most electronic products to be sold in various global markets. The certification needed for the product is specific to the function and design requirements of the countries in which it will be marketed. 2J Antennas will help you understand the complicated process of testing requirements needed to bring a product to market in a specific region and ensure that each device received the required certifications.

At 2J Antennas, we are very aware that the cost and time needed to obtain all of the certifications necessary for your product are one of the most overlooked steps to bringing a new device to market.

 ISO/TS 16949:2009 Automotive standards	 EN ISO 14001:2004 Environmental	 EN ISO 9001:2008 Quality management system		
IP67 Water Resistance	IP69 Hot Water Pressure	IK09 Heavy Duty	UL94-V0 Fire Resistance	EN50155 Railway certificates ESD - CE Vibration, shock Cooling test...

Below is a snapshot of the testing services we provide:

Ingress Protection Testing

Evaluates the resistance to particle and liquid entry for an enclosed product. After testing has been performed, the product receives an IP rating, according to the achieved resistance to solid particles and liquids.

Federal Communications Commission (FCC)

Required in the United States for all electronic products that oscillate at 9 kHz or higher. This regulation falls under what the FCC calls "Title 47 CFR Part 15" (15th subsection of the 47th section of the Code of Federal Regulations).

CISPR 22

In Europe, the requirements are stricter in regards to RF emissions at some frequencies. Other countries and regions have similar regulations on electromagnetic emissions.

Temperature Shock Testing

Thermal shock occurs when devices are forced to undergo rapid temperature changes between extremes. Temperature swings can cause materials to become brittle or cause damage as different materials change size and shape during temperature changes.

Vibration Testing

Vibrations have been known to cause excessive wear, loose fasteners, loosen connections, damage components, and cause devices such as optical equipment to malfunction. For any piece of mobile equipment to be functional, it needs to withstand some vibration. Equipment designed for rugged or hostile environments needs to withstand a lot of vibration without breaking down or wearing out prematurely. And the only way to know if something will withstand its intended application is to test it accordingly.

In-House Manufacturing

We are dedicated to providing an end-to-end manufacturing process.

With full manufacturing capabilities, 2J Antennas is well known for its quick development turnaround time, quality service, experience in wireless technologies and antenna manufacturing process.

Our engineers and designers work closely with the manufacturing team to maximize reliability and quality. The manufacturing of our antennas is performed in-house by our team of engineers, assemblers, and technicians. Plastic injection, SMD pick and place, product assembly and quality control are all carried out in-house, aiding us to be flexible in manufacturing and provide competitively priced products globally.



Our IATF 16949:2016 certified production facility site in Central Europe ensures production of the highest quality products based on proven procedures and techniques. All antennas are manufactured under the RoHS directive and are REACH compliant. Housings can be manufactured with UL94 (plastics flammability standard) or with specified IK standards characteristic materials.

Equipment and Capabilities

We utilize a plethora of modern engineering tools, from network analyzers and anechoic chambers to simulation software and 3D printers. These tools help reduce design phases and enable us to react to our customers' needs promptly and efficiently.

Below is a snapshot of the services, equipment, and capabilities we provide:

- 3D printers
- Anechoic chamber
- Automatic surface mount component assembly machines
- Bar Code Scanning
- Cable printing
- CNC machining
- Coils and spring production with 4-axis CNC versatile forming machine.
- Custom cable assembly
- Custom manufacturing
- Electronic components, cables & parts
- Electronics design/manufacturing
- Flexible circuit board manufacturing
- Modeling/programming
- Mechanical engineering
- Molding
- Network analyzers
- Painting/finishing
- Plastic Injection
- Rapid Prototyping
- RF engineering
- Simulation Software
- Software development
- Single and four color Pad Print
- Testing Equipment
- Ultrasonic Welding

Custom Manufacturing

Having to source a new antenna for a specialized implementation can be a challenging task. In most cases, an off-the-shelf antenna will not be the most optimized solution, as size, connector type, characteristics, durability or antenna performance specifications cannot be defined for the end product. This, in turn, impacts the project by creating more issues for the engineers and designers as they scramble to find the best antenna solution possible for a specific project.

2J Antennas is one of the major antenna manufacturers in the world that performs custom manufacturing of antennas and antenna systems for various applications and markets including Medical, Transportation, Automation, Automotive, IoT, Marine, M2M, and Telematic markets.

For over 18 years, 2J Antennas has designed and manufactured customized antenna solutions for projects with special requirements. With our highly qualified engineering experts, our in-house production facility and our antenna testing site and equipment, 2J Antennas can transform the most unique antenna requirements into cost-effective, reliable solutions.

Antenna Specification Explanation

Antenna Basics and Tips on Antenna Selection & Datasheet Terms explanation

Selecting the right antenna is a critical step during the design and development steps of any connected device. An antenna must be compatible with the receiver specifications and meet device/application requirements such as size, weight, environmental and mechanical. It is important to understand the antenna capabilities and how the specifications meet the device requirements perfectly. Each antenna has a detailed specifications datasheet that can be found under the product details website section.

This guideline provides additional information that expands each datasheet section with a description to assist our customers in selecting the perfect antenna.

Identify your needs

Mounting Types

The initial step during the antenna selection is to determine what mounting type is suitable to meet the application requirements. In order to select the most optimized antenna, start by confirming if the antenna will be integrated internally, such as a mobile device or externally which often comes with housing for protection in outdoor application and installation.

2J Antennas offers a large selection for internal and external single and combination antenna mounting types.

External Single and Combination Antennas Mounting types

- **CONNECTOR MOUNT**
For antennas that require direct PCB mounting solution on devices.
- **ADHESIVE MOUNT**
Using a high-grade adhesive option makes it ideal for quick mounting applications.
- **SCREW MOUNT**
Offers a secure and permanent installation also in outdoor extreme conditions.
- **MAGNETIC MOUNT**
Offers flexibility for temporary installation, strong enough for permanent installations.
- **WALL MOUNT**
Can be used for indoor or outdoor installations.
- **POLE MOUNT**
Ideal often for marine or construction applications.
- **MAGNETIC/ADHESIVE MOUNT**
Offers option of magnetic or adhesive mounting for external installations, especially for non-magnetized metal surfaces.
- **WALL/ADHESIVE MOUNT**
Offers option of wall or adhesive mounting for building wall installations.
- **VELCRO/ADHESIVE MOUNT**
Velcro provides a perfect solution for temporary use of the antennas.

Internal Single and Combination Antennas Mounting types

- **ADHESIVE MOUNT FLEXIBLE**
Small form factor antennas with flexibility for curved installation in devices.
- **ADHESIVE MOUNT RIGID**
Using an industrial-grade adhesive layer. This mounting type is ideal for flat surface installations.
- **SURFACE MOUNT CERAMIC**
With high-quality ceramic, this surface mount is ideal for a wide range of environments and is compatible with surface mount technique (SMT) allowing for easy PCB integration into small devices.
- **SURFACE MOUNT FIBERGLASS**
Fiberglass material allows for the small antenna sizes while offering cost-effective solutions to device designers and is compatible with surface mount technique (SMT) installation.
- **THRU-HOLE MOUNT CERAMIC**
The thru-hole mount is typically in the center of the antenna offering extra security for installation for in-device integration.
- **SNAP-IN MOUNT MODULE**
Locks the antenna in place, prevents unwanted rotation and facilitates rapid antenna installation and replacement.
- **SCREW MOUNT MODULE**
Modular antennas that can be installed on PCB standoffs.



Frequency and Wavelength

The wireless band designated for a device to operate through is called **frequency**. Antennas are designed to have a range of frequencies to operate within. As an example, if a device is tuned to use Band 17(700MHz), the corresponding antenna must operate within 704 and 746 MHz for transmission and reception.

The **wavelength** is the distance radio waves travel during one cycle. Designing an antenna quarter wavelength long will provide the best efficiency and deliver the highest signal quality.

Quarter wavelength is calculated with the following formula:
Quarter Wavelength(mm) = (75/ Freq_{MHz})*1,000

IMPORTANT: 4GLTE and 3G/2G antennas have the potential to be used in applications requiring ISM standards. 4GLTE range specification of 698-960MHz and 3G/2G from 824-960MHz, meaning the ISM 868MHz standards operate from 863-870MHz and are located within the 4GLTE and 3G/2G range. The same applies for ISM 915MHz standards that operate within 902-928MHz, or dual band 868/915MHz.

To ensure proper compatibility, please contact our sales department for further analysis.

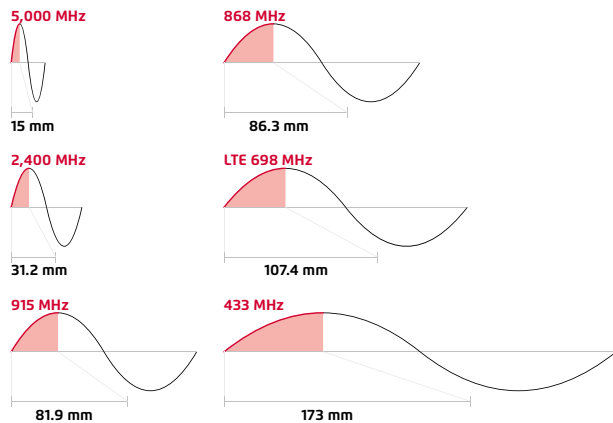

Fig.1, Examples of 1/4 wavelength; Frequency / Length graph

Standards & Bands

2J Antennas offers antennas that operate within many global standards. As example, our 4G LTE antennas are compatible with Cat-M, Cat-X, Cat-NB, NB-IoT and also SigFox and LoRa, known as LPWA market. The same analogy can apply often to other frequencies. As an example, WIFI antennas can be used for SigFox or LoRa in the 2.4 GHz spectrum. GNSS antennas are available with pre-filter, mid-filter or no-filter to meet the customers' different requirements. The pre-filter offers the highest resistance and best reception and therefore is standard on all GNSS antennas. It is important to compare active gain and noise on the amplifier of GNSS antennas.

Antenna standards We offer:

- 5GNR/4GLTE/FirstNet/CBRS/LPWA/3G/2G
- 4GLTE/FirstNet/NB-IoT/Cat-X-Mx-NBx/LPWA
- 3G/2G
- 2.4-5.0GHz WiFi/Bluetooth/ISM
- IRIDIUM
- GPS/GLONASS/BeiDou/QZSS/Galileo
- 433/868/915MHz/LPWA/Sigfox/LoRa
- /RFID/ZigBee/ISM
- TETRA/UHF/PMR/LMR
- 169MHz/ERMES/VHF
- DECAWAVE
- DSRC/C-V2X
- ORBCOMM
- AIS
- DAB
- HDTV/DVBT
- AM/FM

Antenna standards We offer:

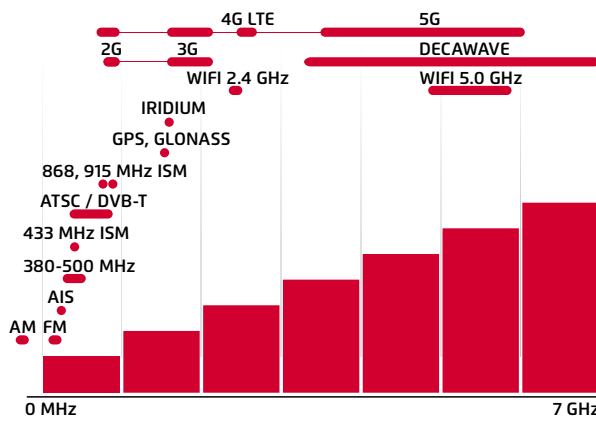

Fig.2, Frequency showing Standards Graph

Terms Explanation

Part of antenna selection is not only to identify the specification needs but also compare other products. It is important to understand the parameters in which the antennas are tested and measured to achieve the most reliable performance results. To help our customers find the best product, we have highlighted some of the key points to pay close attention to during antenna selection and comparison.

Testing Parameters

Testing parameters and testing methods can vary from manufacturer to manufacturer. Testing methods should always be fully disclosed such as free space, metal plate, plastic plate, glass, etc. Installing antennas outside of testing parameters will result in undesired antenna performance. For example, if a screw mount antenna is measured in free space showing optimal performance results and is installed on a metal surface in the customer device, the antenna will not operate as expected. 2J Antennas will always disclose the complete measurement conditions to assure our customers get the most accurate data making the in-device integration of an antenna successful.

In order to make a smart product selection between two manufacturers, we encourage that all testing should be completed with a standard length and high-quality cable in order to optimize antenna performance results. No alterations during testing such as shorter or no cables should be performed. This will result in inaccurate efficiency, peak gain and average gain results.

2J Antennas values transparency. This is important when comparing antenna products from different manufacturers.

Return Loss

The return loss is measured in decibels (dB) and represents how much energy is transferred from the device to the antenna. The lower the measurement the better. For a 50 Ohm system, it is recommended to have a minimum of -5dB or better measurement. Using the return loss to identify how the impedance of the antenna performs across the entire spectrum can help to estimate the bandwidth and operating frequencies.

VSWR

Voltage Standing Wave Ratio (VSWR) is another parameter used to measure how much energy is transferred from the device to the antenna but with a different mathematical scale than the one used for Return Loss. The lower the measurement the better, meaning closer to a 50 Ohm system and it is recommended to have a maximum of 3.5 VSWR. Please review the table below to learn more about the relationship

between Return Loss and VSWR as well as other RF parameters and values.

Return Loss (dB)	VSWR	Reflection Coefficient, Γ	Mismatch Loss (dB)	Reflected Power (%)	Through Power (%)
-1	17.39	0.89	6.87	79.43	20.57
-2	8.72	0.79	4.33	63.10	36.90
-3	5.85	0.71	3.20	50.12	49.88
-4	4.42	0.63	2.20	39.81	60.19
-5	3.57	0.56	1.65	31.62	68.38
-6	3.10	0.50	1.26	25.12	74.88
-7	2.61	0.45	0.97	19.95	80.05
-8	2.32	0.40	0.75	15.85	84.15
-9	2.10	0.36	0.58	12.59	87.41
-10	1.92	0.32	0.46	10.00	90.00
-11	1.78	0.28	0.36	7.94	92.06
-12	1.67	0.25	0.28	6.31	93.69
-13	1.58	0.22	0.22	5.01	94.99
-14	1.50	0.20	0.18	3.98	96.02
-15	1.43	0.18	0.14	3.16	96.84
-16	1.38	0.16	0.11	2.51	97.49
-17	1.33	0.14	0.09	2.00	98.00
-18	1.29	0.13	0.07	1.58	98.42
-19	1.25	0.11	0.06	1.26	98.74
-20	1.22	0.10	0.04	1.00	99.00

Table 1, Return Loss to VSWR Conversion Table, and more RF parameters.

Bandwidth

Bandwidth is a range of frequencies. A short frequency range is a narrow band and wider frequency range is categorized as a wideband. It is important to select the right antenna with the matching bandwidth as narrowband and wideband are not interchangeable.

Efficiency

Antenna efficiency (radiation efficiency) is a measure of the electrical efficiency in which a radio antenna converts the radio frequency power received into radiated power. In other words means how much energy is radiated from the antenna to the air, how good is the antenna to radiate the energy. Being the most important parameter of an antenna in mobile communications. 100% means all energy radiated, 50% means half energy radiated, the minimum recommended is 25% but in some cases can go down to 10%, but the higher the better.

Peak Gain

Antenna gain is the measurement of an antenna's ability to direct or concentrate radio frequency energy in a particular direction or pattern. This is typically measured in dBi (Decibels relative to an isotropic radiator). The most crucial parameter in mobile communication is antenna efficiency followed by peak gain. Efficiency measures how much energy is in the air radiating in all directions, while peak gain is only measured in a single direction. While in fixed communication the most important parameter is the peak gain, since all the energy must be concentrated in one single direction.

This value comes from a single point in the radiation pattern being the maximum point in the 3D sphere.

Average Gain

Similar to efficiency, the average gain is represented with a different mathematical scale (dB) and takes into consideration any mismatch losses. 100% is 0 dB which is maximum radiated energy, 50% is -3 dB which is half of the radiated energy, etc.

Please see below table for the relationship between efficiency and average gain:

Efficiency (%)	Average Gain (dB)
100%	0.0 dB
90%	-0.5 dB
80%	-1.0 dB
70%	-1.5 dB
60%	-2.2 dB
50%	-3.0 dB
40%	-4.0 dB
30%	-5.2 dB
25%	-6.0 dB
20%	-7.0 dB
10%	-10.0 dB
1%	-20.0 dB

Table 2, Efficiency/ Average Gain Table

Radiation Patterns

The radiation pattern of an antenna is the strength of radio waves transmitted by the antenna traveling in different directions and angles.

Omnidirectional antennas offer a 360-degree doughnut-shaped radiation pattern that is uniformly distributed in all directions and are ideal for connecting devices that are on the same plane and to either side of each other. Hemispherical antennas distribute their radiation over a hemisphere (half of the space). Directional antennas radiate into one targeted direction allowing for longer transmission distances with less interference.

The plot graph will show how the energy is being radiated to the air in 3 dimensional or 2 dimensional pattern. In 2D graph pattern, the horizontal and vertical planes are shown. See example in the graph below Fig.3.

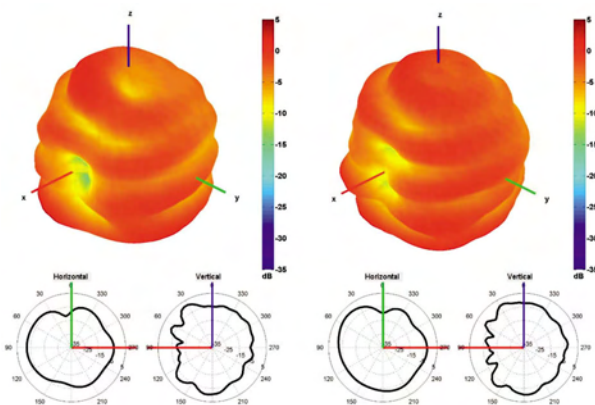

Fig.3, Radiation Pattern 3D and 2D Graph

Polarization

Polarization is the orientation of the electric field of an electromagnetic wave. The two most common polarizations are linear and circular. Measurement and changes of polarization are determined in which the wave transmits through the environment from the transmitting to the receiving antenna.

With linear polarization, the electric field vector stays in the same plane were in with circular polarization, the electric field vector is rotating with circular motion completing a full turn for each RF cycle. This rotation can be completed right-hand (RHCP) or left-hand (LHCP).

General Information / Specification

Ground Plane

2J Antennas offers both, ground plane dependent and ground plane independent antennas. A ground plane is a surface area or metal that acts as a conductor and reflects the radio waves from other antenna components. The shape, size and the required clear area of the ground plane play an important role in determining radiation characteristics and gain.

Low-frequency antennas such as broadcast antennas accept large conducting masses such as the earth or ocean as a sufficient ground plane. For very high frequency (VHF) and ultra-high frequency (UHF) antennas, the ground plane can be smaller and a metal disk, screen or wire is used as a ground plane. In automotive, marine and air equipment metal housing (car / airplane / boat) can serve as a sufficient ground plane.

As a general rule, the conduction surface must be at least a quarter of the wavelength of the radio waves in diameter and in ideal condition the bigger the ground plane the better control of the electrical performance is achieved between Return Loss and VSWR as well as other RF parameters and values.

Maximum Input Power

The Maximum Input Power is the maximum amount of power (in Watts) that can be transmitted to one antenna port without damaging it while maintaining performance.

Cable and Connector Types

The correct selection of RF cable and connector types is critical to proper antenna function. The connector serves as a mechanical connection between the antenna and RF system and the cable is the transmission line for radio frequency signals connecting transmitters and receivers. The cable lengths impact signal quality and strength. Selecting a high-quality cable and connector that is compatible with the antenna will ensure optimal antenna performance. When considering a product, it is important to determine the correct connector gender, polarity and geometry as well as the cable length prior to a quote request.

2J Antennas offers a wide range of high-quality connectors and cables as standard and also offers alternatives for any customization needs.

2J Antennas is confident that we have the right antenna for your needs. We offer a wide range of off-the-shelf products, reducing costs during design stages and product life cycle. Our expert team of engineers is available for any customization requirements to meet all our customers' needs.



Cable Assembly

- Measurement and Tolerances & Connector Orientation Guideline

External Single and Combination Antenna with Cable assembly

Center of automotive nut to end of straight connector or to center pin for right angle and micro-coax connector.

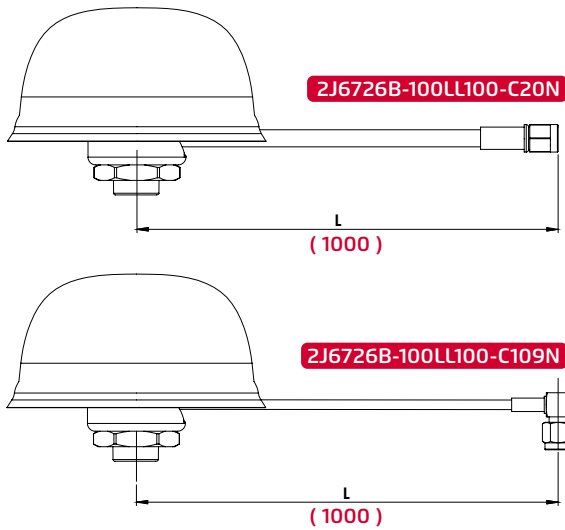

Antenna base exit to end of straight connector or to center pin for right angle and micro-coax connector.

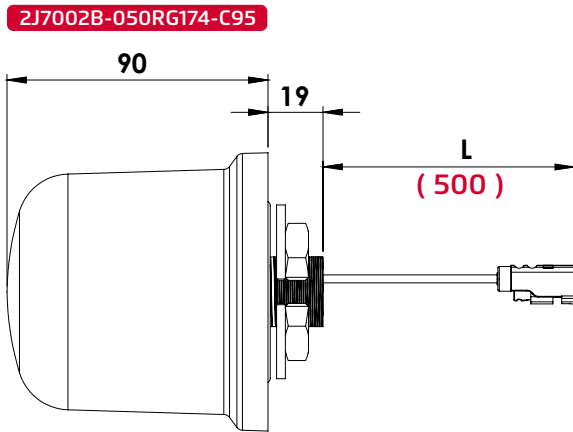

2J6615B-050RG174-C109N

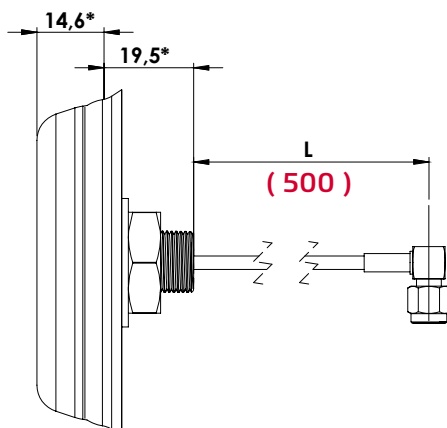

*L = CABLE LENGTH (in mm)

Antenna radome exit to end of straight connector or to center pin for right angle and micro-coax connector.

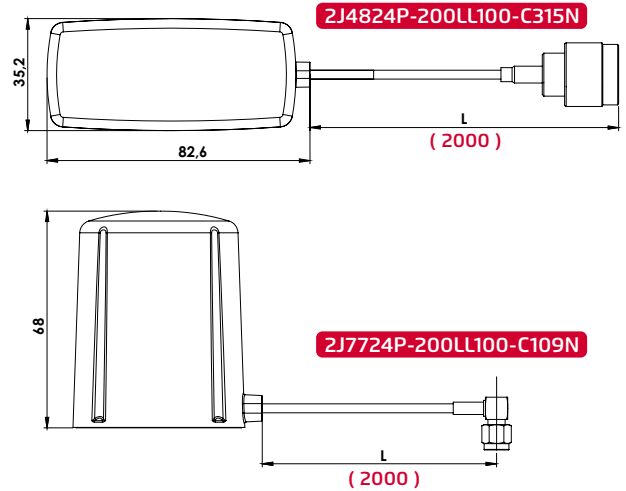

Internal Adhesive Mount Flexible and Rigid Antenna with Cable Assembly

Cable jacket to the end of straight connector or to center pin for right angle and micro-coax connector.

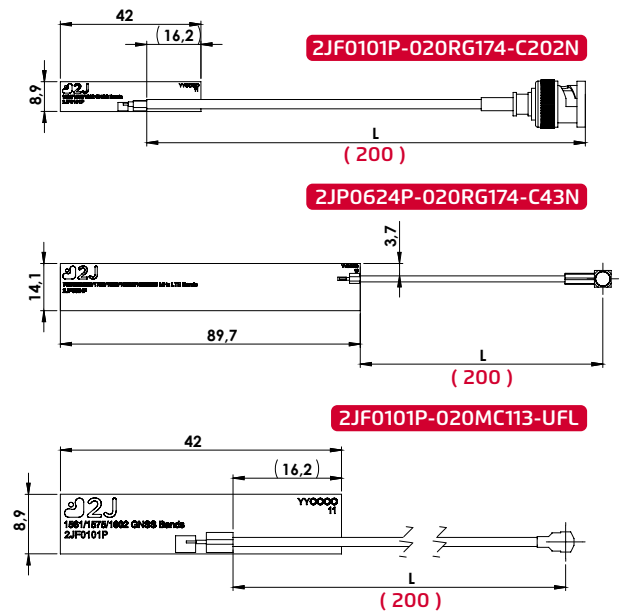

Internal Adhesive Mount Flexible and Rigid Antenna with Cable Assembly

Cable jacket to the end of straight connector or to center pin for right angle and micro-coax connector.

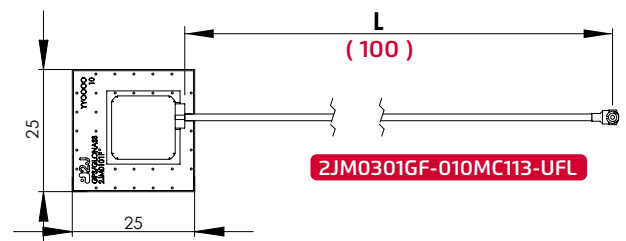

Cable Assembly Measurement and Tolerances

2JP0133GF-010MC137-UFL_UFL

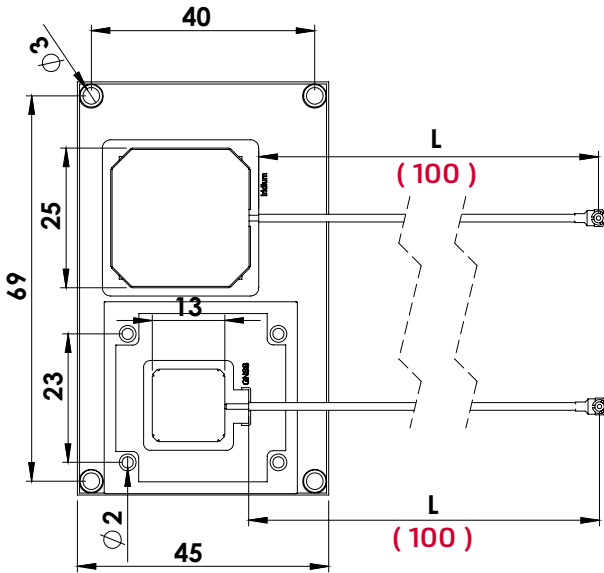

Internal GNSS Antenna Receiver with Cable Assembly

Solder pad edge to the end of straight connector.

2JR02ai2-030UL2725-USB

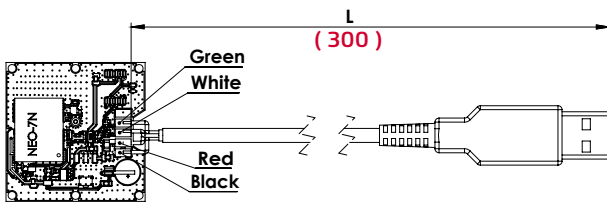

Connector to Connector Cable Assembly

End to end of straight connector or to center pin for right angle and micro-coax connectors.

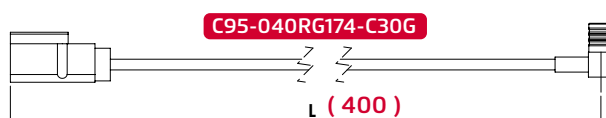
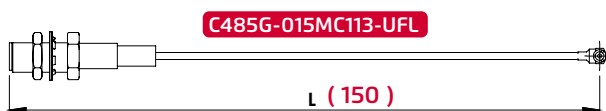
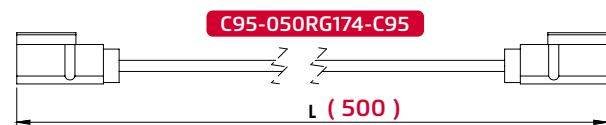

Center pin to center pin for right angle and micro-coax connectors.

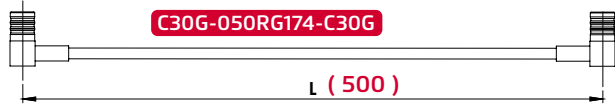
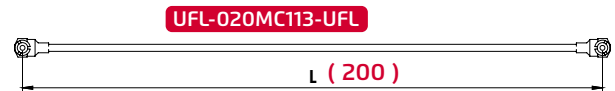

Stripped-end to Connector Cable Assembly

Cable jacket to end of straight connector or to center pin for right angle and micro-coax connectors.

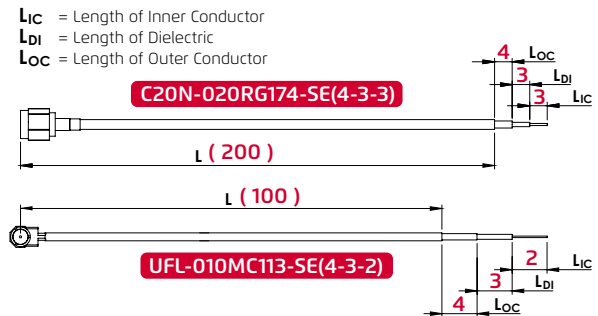

Stripped-end to Stripped-end Cable

Cable jacket to cable jacket.

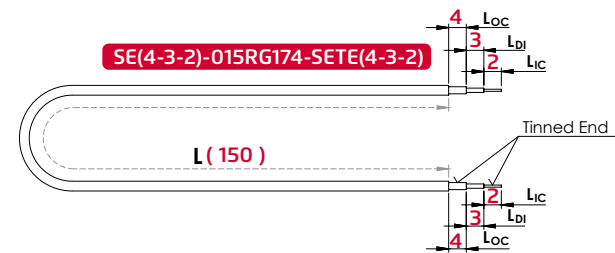

Cut-end to Stripped-end Cable

Cable jacket to cable jacket.

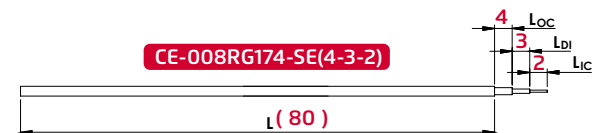

Cut-end to Cut-end Cable

Cable jacket to cable jacket.

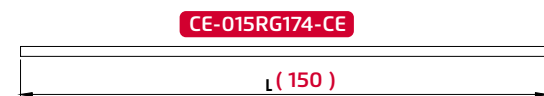

Cut-end to Connector Cable Assembly

Cut-end to end of straight connectors or to center pin for right angle and micro-coax connectors.

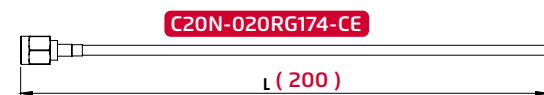

*L = CABLE LENGTH (in mm)

Connector Orientation Guideline

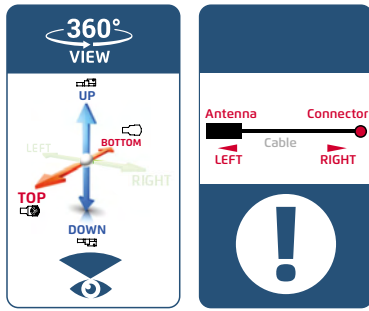

To set correct connector orientation always look the product from left (Product) to right (Connector).

Connector orientation - PCB products

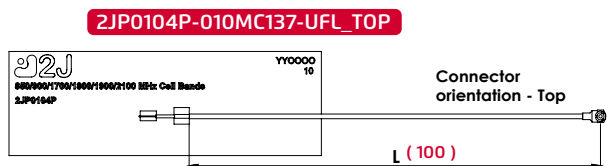
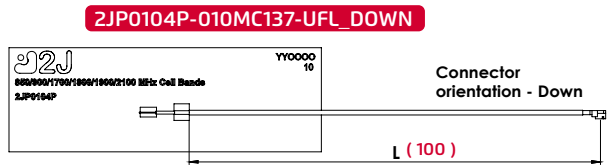
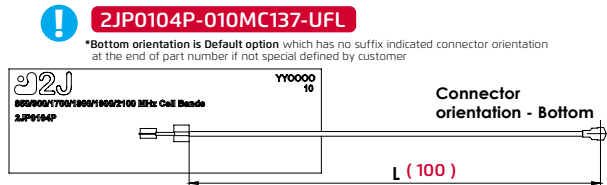
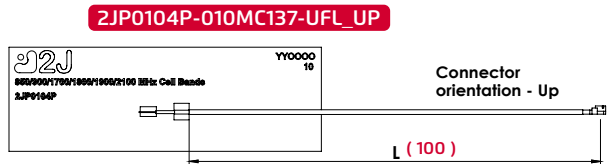

Connector orientation - PCB products

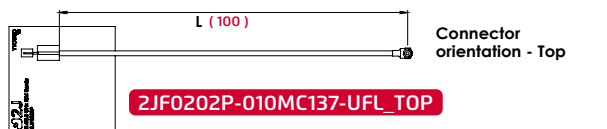
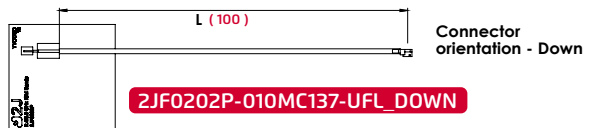
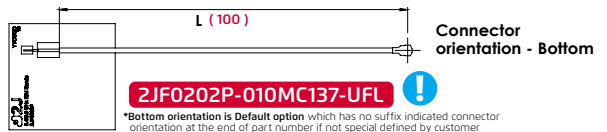
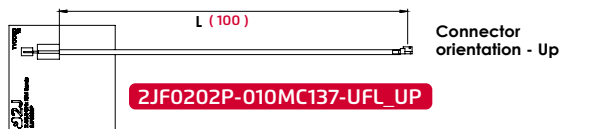

*L = CABLE LENGTH (in mm)

Connector orientation - Modules

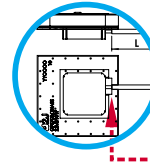

! Cable length measurement starts from the Cable Jacket

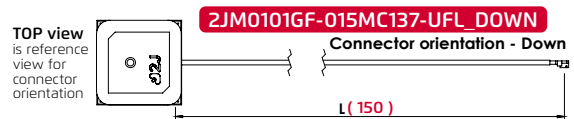
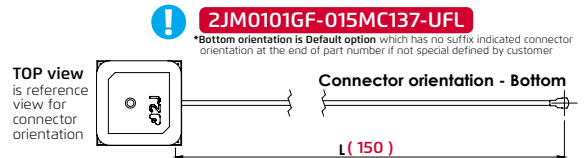
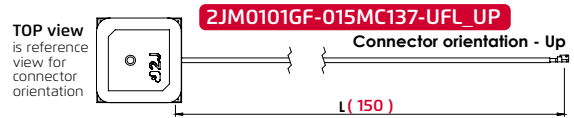

Connector orientation - Cable Leads

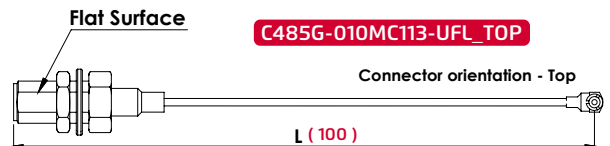
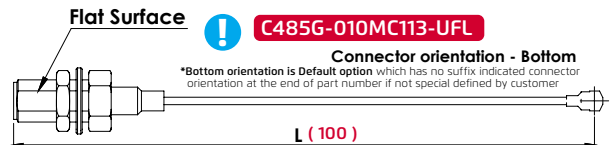
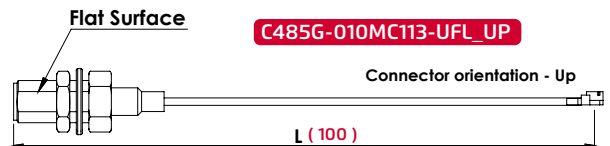

Cable Assembly Tolerances

LENGTH (mm)	TOLERANCE +/-
0 to 49	1
50 to 99	2
100 to 499	3
500 to 999	5
1,000 to 2,999	20
3,000 to 4,999	30
5,000 to 9,999	40
10,000 or More	50

Single

External Antennas



5G NR Antenna Bands list

Parameters Technologies	5G NR Antenna 5G, 4G, 3G and 2G			
Frequency (MHz)	617-960	1427-2690	3300-5000	5150-5925
Band (MHz)	600, 700, 850, 900	1500, 1600, 1700, 1800, 1900, 2000, 2100, 2300, 2500, 2600	3300, 3500, 3600, 3700, 4500	5200, 5500, 5800
5G NR Bands	n5, n8, n12, n20, n28, n71, n81, n82, n83,	n1, n2, n3, n7, n25, n34, n38, n39, n40, n41, n50, n51, n66, n70, n74, n75, n76, n80, n84, n86	n77, n78, n79	
4G LTE Bands	B5, B6, B8, B12, B13, B14, B17, B18, B19, B20, B26, B27, B28, B29, B44, B67, B68, B71, B85	B1, B2, B3, B4, B7, B9, B10, B11, B21, B23, B24, B25, B30, B32, B33, B34, B35, B36, B37, B38, B39, B40, B41, B45, B50, B51, B65, B66, B69, B70, B74, B75, B76	B22, B42, B43, B48, B49, B52	B46, B47, B252, B255
3G CELL Bands	B5, B6, B8, B12, B13, B14, B19, B20, B26	B1, B2, B3, B4, B7, B9, B10, B11, B21, B25, B32, B33, B34, B35, B36, B37, B38, B39, B40	B22	
2G CELL Bands	710, 750, 810T, 850, 900P, 900E, 900R	1800DCS, 1900PCS		
CDMA CELL Bands	BC0, BC2, BC3, BC7, BC9, BC10, BC12, BC18, BC19	BC1, BC4, BC6, BC8, BC13, BC14, BC15, BC16, BC20, BC21		

2JW0183z-C868B 5G Antenna

5G NR/4G LTE/FirstNet/CBRS/LPWA/3G/2G

Key Features  High Performance  Ultra Wide band Antenna  Ground Plane Independent  Hinged Connector



General specification





Mounting type	Connector mount
Dimensions (mm)	171 × 38 × 13.8
Operating temperature	-40 °C to +85 °C

Antenna and electrical specifications

5G NR/4G LTE/FirstNet/CBRS/LPWA/3G/2G	
Standards	5G NR/4G LTE/FirstNet/CBRS/LPWA/ CAT-X/CAT-Mx/CAT-NBx/NB-IoT/3G/2G
Frequency (MHz)	617-960, 1427-2690, 3300-5000, 5150-5925
Bands	see 5G Bands list on page 17
VSWR	~2.8:1, ~2.5:1, ~5.1:1, ~3.9:1
Efficiency (%)	~51.9, ~68.4, ~40.0, ~38.3
Peak Gain (dBi)	~0.0, ~-1.7, ~-1.1, ~-1.6
Impedance (Ohm)	50
Polarisation	Linear
Radiation Pattern	Omni-Directional
Max. Input Power (W)	25

2JW1183-C952B 5G Antenna

5G NR/4G LTE/FirstNet/CBRS/LPWA/3G/2G

Key Features  High Performance  Ultra Wide band Antenna  Ground Plane Independent  Hinged Connector

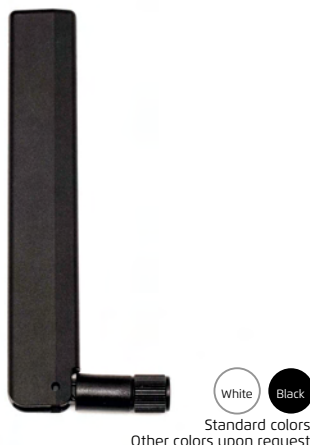

General specification

Mounting type	Connector mount
Dimensions (mm)	135 × 19 × 10
Operating temperature	-40 °C to +85 °C

Antenna and electrical specifications

5G NR/4G LTE/FirstNet/CBRS/LPWA/3G/2G	
Standards	5G NR/4G LTE/FirstNet/CBRS/LPWA/ CAT-X/CAT-Mx/CAT-NBx/NB-IoT/3G/2G
Frequency (MHz)	617-960, 1427-2690, 3300-5000, 5150-5925
Bands	see 5G Bands list on page 17
VSWR	~2.0:1, ~2.6:1, ~2.3:1, ~2.2:1
Efficiency (%)	~37.6, ~43.3, ~35.1, ~41.9
Peak Gain (dBi)	~-1.1, ~-0.5, ~-0.3, ~-1.6
Impedance (Ohm)	50
Polarisation	Linear
Radiation Pattern	Omni-Directional
Max. Input Power (W)	25

2JW1483 5G Antenna

5GNR/4GLTE/FirstNet/CBRS/LPWA/3G/2G

Key Features  High Performance  Ultra Wide band Antenna  Ground Plane Independent  Certificates: IP67 - Water Resistant



Standard colors.
Other colors upon request.

General specification

Mounting type	Connector mount
Dimensions (mm)	192 × 20 × 18
Operating temperature	-40 °C to +85 °C
Certificates	IP67

Antenna and electrical specifications

5GNR/4GLTE/FirstNet/CBRS/LPWA/3G/2G

Standards	5GNR/4GLTE/FirstNet/CBRS/LPWA/ CAT-X/CAT-Mx/CAT-NBx/NB-IoT/3G/2G
Frequency (MHz)	617-960, 1525-2690, 3300-3800
Bands	see 5G Bands list on page 17
VSWR	~1.6:1, ~1.7:1, ~6.3:1
Efficiency (%)	~50.0, ~55.2, ~28.1
Peak Gain (dBi)	~-0.4, ~0.6, ~-1.6
Impedance (Ohm)	50
Polarisation	Linear
Radiation Pattern	Omni-Directional
Max. Input Power (W)	25

2JOB24-C884G

4GLTE/FirstNet/LPWA/NB-IoT/3G/2G

Key Features  Low Profile  Wide band Antenna  Ground Plane Dependent  Right-Angle Connector



Standard colors.
Other colors upon request.

General specification

Mounting type	Connector mount
Dimensions (mm)	44 × 19.1 × 9
Operating temperature	-40 °C to +85 °C

Antenna and electrical specifications

4GLTE/FirstNet/LPWA/NB-IoT/3G/2G

Standards	4GLTE/FirstNet/LPWA/ CAT-X/CAT-Mx/CAT-NBx/NB-IoT/3G/2G
Frequency (MHz)	698-960, 1710-2170
VSWR	~3.3:1, ~1.8:1
Efficiency (%)	~56.6, ~65.6
Peak Gain (dBi)	~-1.0, ~-2.2
Impedance (Ohm)	50
Polarisation	Linear
Radiation Pattern	Omni-Directional
Max. Input Power (W)	25

2JOB24-C885G

4GLTE/FirstNet/LPWA/NB-IoT/3G/2G

Key Features  Low Profile  Wide band Antenna  Ground Plane Dependent  Right-Angle Connector



Standard colors.
Other colors upon request.

General specification

Mounting type	Connector mount
Dimensions (mm)	48 × Ø 9
Operating temperature	-40 °C to +85 °C

Antenna and electrical specifications

4GLTE/FirstNet/LPWA/NB-IoT/3G/2G

Standards	4GLTE/FirstNet/LPWA/ CAT-X/CAT-Mx/CAT-NBx/NB-IoT/3G/2G
Frequency (MHz)	698-960, 1710-2170
VSWR	~3.8:1, ~2.0:1
Efficiency (%)	~44.9, ~57.0
Peak Gain (dBi)	~-1.0, ~-2.6
Impedance (Ohm)	50
Polarisation	Linear
Radiation Pattern	Omni-Directional
Max. Input Power (W)	25

2J2124-C315N

4GLTE/FirstNet/LPWA/NB-IoT/3G/2G

Key Features  N-Male connector  Ground Plane Independent

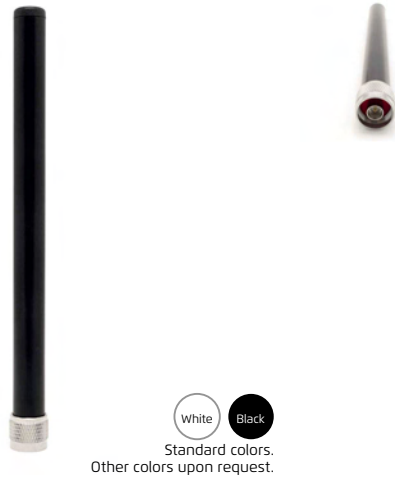

General specification



Mounting type	Connector mount
Dimensions (mm)	232 × Ø 20 (Ø 16)
Operating temperature	-40 °C to +85 °C

Antenna and electrical specifications 4GLTE/FirstNet/LPWA/NB-IoT/3G/2G

Standards	4GLTE/FirstNet/LPWA/ CAT-X/CAT-Mx/CAT-NBx/NB-IoT/3G/2G
Frequency (MHz)	698-960, 1710-2170, 2500-2700
VSWR	~1.8:1, ~1.5:1, ~2.0:1
Efficiency (%)	~55, ~58, ~71
Peak Gain (dBi)	~0.3, ~1.7, ~2.3
Impedance (Ohm)	50
Polarisation	Linear
Radiation Pattern	Omni-Directional
Max. Input Power (W)	25

2JW1024

4GLTE/FirstNet/LPWA/NB-IoT/3G/2G

Key Features  High Efficiency  Low Profile  Ground Plane Dependent  Hinged Connector



General specification

Mounting type	Connector mount
Dimensions (mm)	Ø 10 × 71
Operating temperature	-40 °C to +85 °C

Antenna and electrical specifications 4GLTE/FirstNet/LPWA/NB-IoT/3G/2G

Standards	4GLTE/FirstNet/LPWA/ CAT-X/CAT-Mx/CAT-NBx/NB-IoT/3G/2G
Frequency (MHz)	698-960, 1710-2170, 2500-2700
VSWR	~3.1:1, ~1.7:1, ~1.5:1
Efficiency (%)	~58, ~67, ~74
Peak Gain (dBi)	~0.1, ~2.9, ~4.6
Impedance (Ohm)	50
Polarisation	Linear
Radiation Pattern	Omni-Directional
Max. Input Power (W)	10

2JW0124 Antenna

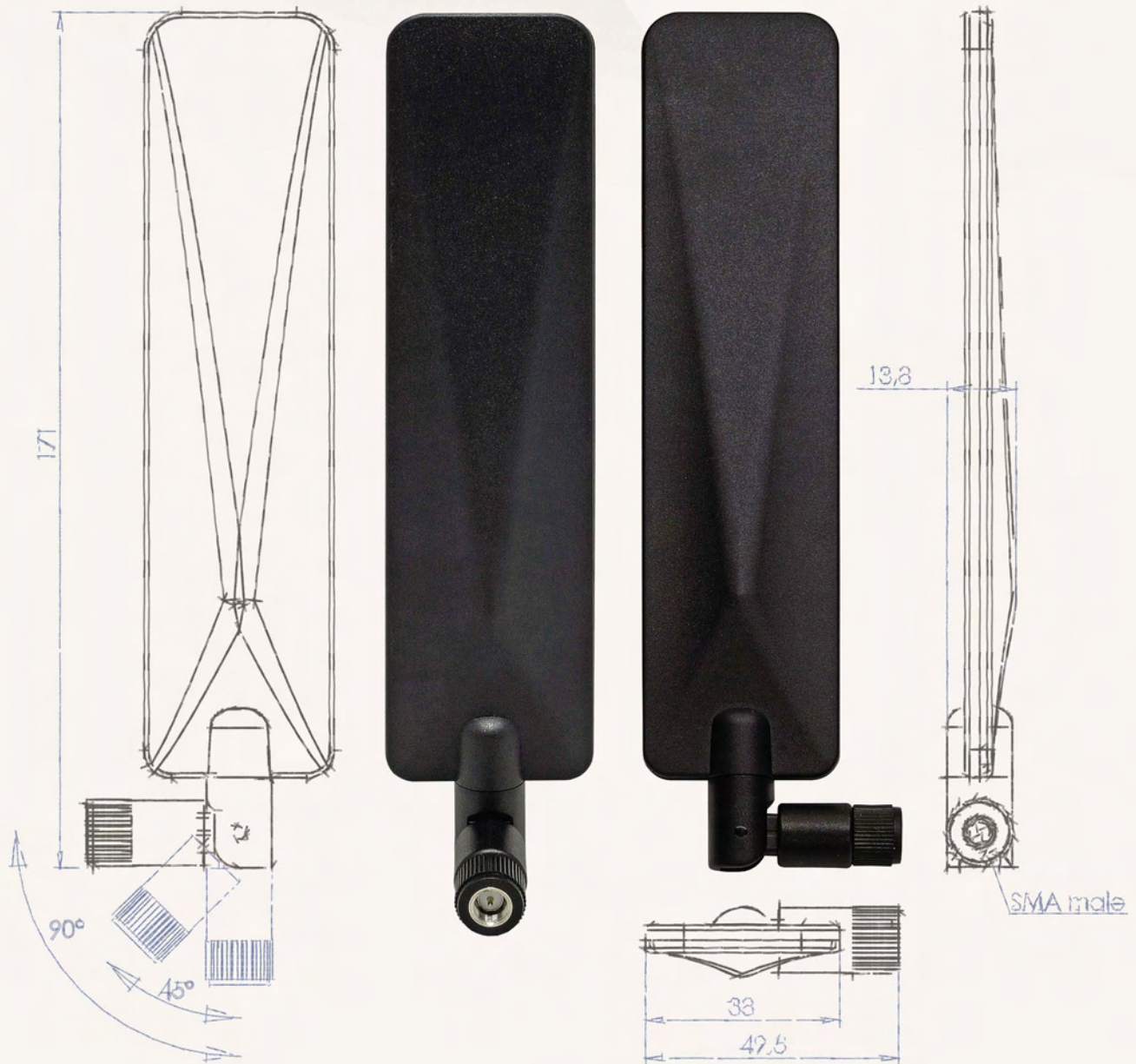

Made for worldwide cellular applications

The 2JW0124 series is an ultra wideband performance connector mount antenna solution for worldwide cellular applications operating within the 4G, 3G and 2G standards. This series is compatible with 4GLTE/FirstNet/LPWA/CAT-X/CAT-Mx/CAT-NBx/NB-IoT/3G/2G technologies, covering all cellular bands ranging from 698-960, 1710-2170 and 2500-2700 MHz. With a 75% high efficiency, 3.0dB average gain and omnidirectional properties, this antenna provides consistent and stable connectivity with high throughput data to access points, routers, small base stations, repeaters, boosters, fleet management devices and other telematics devices with cellular needs.

This antenna is ideal for major carrier approvals and certification process around the globe. The antenna can freely swivel up to 90 degrees, having flexibility in orientation with respect to the device for easier installation or multiple antenna mounting options.

Installation

There are two variations of mounting swivels allowing for multiple antennas on devices with MIMO systems. Connector types can be selected between SMA-Male, RP SMA-Male or N-Male. See the different swivel orientation on 2JW0124z antenna.

Durability

The 2JW0124 series is intended for indoor and internal use only. As a protective measure, the housing is built out of UV Stable material with a range for an operating temperature of -40°C to +85°C. All antennas are manufactured using RoHS, REACH compliance.

2JW0124z-C868B

4GLTE/FirstNet/LPWA/NB-IoT/3G/2G

Key Features ✓ High Performance ✓ Ultra Wide band Antenna ✓ Ground Plane Independent ✓ Hinged Connector



General specification

Mounting type	Connector mount
Dimensions (mm)	171 × 38 × 13.8
Operating temperature	-40 °C to +85 °C

Antenna and electrical specifications

4GLTE/FirstNet/LPWA/NB-IoT/3G/2G

Standards	4GLTE/FirstNet/LPWA/ CAT-X/CAT-Mx/CAT-NBx/NB-IoT/3G/2G
Frequency (MHz)	698-960, 1710-2170, 2500-2700
VSWR	~2.4:1, ~1.6:1, ~2.2:1
Efficiency (%)	~62, ~75, ~50
Peak Gain (dBi)	~0.4, ~2.6, ~1.3
Impedance (Ohm)	50
Polarisation	Linear
Radiation Pattern	Omni-Directional
Max. Input Power (W)	25

2JW0124z-C955N

4GLTE/FirstNet/LPWA/NB-IoT/3G/2G

Key Features ✓ High Performance ✓ Ultra Wide band Antenna ✓ Ground Plane Independent ✓ Hinged Connector ✓ N-Male connector



General specification

Mounting type	Connector mount
Dimensions (mm)	205 × 38 × 19
Operating temperature	-40 °C to +85 °C

Antenna and electrical specifications

4GLTE/FirstNet/LPWA/NB-IoT/3G/2G

Standards	4GLTE/FirstNet/LPWA/ CAT-X/CAT-Mx/CAT-NBx/NB-IoT/3G/2G
Frequency (MHz)	698-960, 1710-2170, 2500-2700
VSWR	~2.4:1, ~1.6:1, ~2.2:1
Efficiency (%)	~62, ~75, ~50
Peak Gain (dBi)	~0.4, ~2.6, ~1.3
Impedance (Ohm)	50
Polarisation	Linear
Radiation Pattern	Omni-Directional
Max. Input Power (W)	25

2JW0124-C868B

4GLTE/FirstNet/LPWA/NB-IoT/3G/2G

Key Features ✓ High Performance ✓ Ultra Wide band Antenna ✓ Ground Plane Independent ✓ Hinged Connector



General specification

Mounting type	Connector mount
Dimensions (mm)	171 × 38 × 13.8
Operating temperature	-40 °C to +85 °C

Antenna and electrical specifications

4GLTE/FirstNet/LPWA/NB-IoT/3G/2G

Standards	4GLTE/FirstNet/LPWA/ CAT-X/CAT-Mx/CAT-NBx/NB-IoT/3G/2G
Frequency (MHz)	698-960, 1710-2170, 2500-2700
VSWR	~2.4:1, ~1.6:1, ~2.2:1
Efficiency (%)	~62, ~75, ~50
Peak Gain (dBi)	~0.4, ~2.6, ~1.3
Impedance (Ohm)	50
Polarisation	Linear
Radiation Pattern	Omni-Directional
Max. Input Power (W)	25

2JW0124-C955N

4GLTE/FirstNet/LPWA/NB-IoT/3G/2G

Key Features  High Performance  Ultra Wide band Antenna  Ground Plane Independent  Hinged Connector  N-Male connector



General specification

Mounting type	Connector mount
Dimensions (mm)	205 × 38 × 19
Operating temperature	-40 °C to +85 °C

Antenna and electrical specifications

4GLTE/FirstNet/LPWA/NB-IoT/3G/2G

Standards	4GLTE/FirstNet/LPWA/ CAT-X/CAT-Mx/CAT-NBx/NB-IoT/3G/2G
Frequency (MHz)	698-960, 1710-2170, 2500-2700
VSWR	~2.4:1, ~1.6:1, ~2.2:1
Efficiency (%)	~62, ~75, ~50
Peak Gain (dBi)	~0.4, ~2.6, ~1.3
Impedance (Ohm)	50
Polarisation	Linear
Radiation Pattern	Omni-Directional
Max. Input Power (W)	25

2JW0924-C952B

4GLTE/FirstNet/LPWA/NB-IoT/3G/2G

Key Features  High Performance  Ultra Wide band Antenna  Ground Plane Independent  Hinged Connector

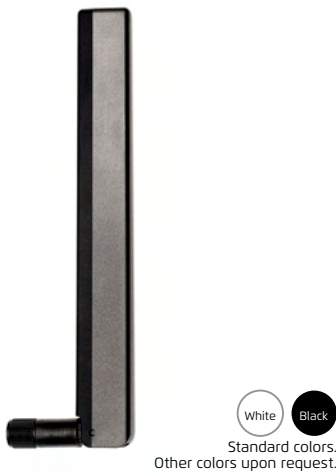

General specification

Mounting type	Connector mount
Dimensions (mm)	170 × 18 × 10
Operating temperature	-40 °C to +85 °C

Antenna and electrical specifications

4GLTE/FirstNet/LPWA/NB-IoT/3G/2G

Standards	4GLTE/FirstNet/LPWA/ CAT-X/CAT-Mx/CAT-NBx/NB-IoT/3G/2G
Frequency (MHz)	698-960, 1710-2170, 2500-2700
VSWR	~1.7:1, ~1.5:1, ~1.3:1
Efficiency (%)	~54, ~60, ~67
Peak Gain (dBi)	~0.6, ~2.6, ~2.3
Impedance (Ohm)	50
Polarisation	Linear
Radiation Pattern	Omni-Directional
Max. Input Power (W)	25

2JW1124-C952B

4GLTE/FirstNet/LPWA/NB-IoT/3G/2G

Key Features  High Performance  Ultra Wide band Antenna  Ground Plane Independent  Hinged Connector



General specification

Mounting type	Connector mount
Dimensions (mm)	135 × 19 × 10
Operating temperature	-40 °C to +85 °C

Antenna and electrical specifications

4GLTE/FirstNet/LPWA/NB-IoT/3G/2G

Standards	4GLTE/FirstNet/LPWA/ CAT-X/CAT-Mx/CAT-NBx/NB-IoT/3G/2G
Frequency (MHz)	698-960, 1710-2170, 2500-2700
VSWR	~1.6:1, ~2.1:1, ~2.3:1
Efficiency (%)	~41.6, ~57.6, ~55
Peak Gain (dBi)	~-1.6, ~1.5, ~2.9
Impedance (Ohm)	50
Polarisation	Linear
Radiation Pattern	Omni-Directional
Max. Input Power (W)	25

2J0504-C20N

3G/2G/CELLULAR

Key Features ✓ Low Profile ✓ Ground Plane Dependent



General specification

Mounting type	Connector mount
Dimensions (mm)	Ø 12.6 × 54.7
Operating temperature	-40 °C to +85 °C

Antenna and electrical specifications

3G/2G/CELLULAR

Standards	3G/Cellular/HSPA/UMTS/WCDA/ EDGE/EGPRS/GRPS/GSM/CDMA/2G
Frequency (MHz)	824-960, 1710-2170
VSWR	~1.7:1, ~3.1:1
Efficiency (%)	~60.7, ~48.6
Peak Gain (dBi)	~0.6, ~2.0
Impedance (Ohm)	50
Polarisation	Linear
Radiation Pattern	Omni-Directional
Max. Input Power (W)	25

2JOB04-C884G

3G/2G/CELLULAR

Key Features ✓ High Performance ✓ Ground Plane Dependent ✓ Low Profile ✓ Right-Angle Connector



General specification

Mounting type	Connector mount
Dimensions (mm)	44 × 19.1 × 9
Operating temperature	-40 °C to +85 °C

Antenna and electrical specifications

3G/2G/CELLULAR

Standards	3G/Cellular/HSPA/UMTS/WCDA/ EDGE/EGPRS/GRPS/GSM/CDMA/2G
Frequency (MHz)	824-960, 1710-2170
VSWR	~2.2:1, ~2.4:1
Efficiency (%)	~70.6, ~56.4
Peak Gain (dBi)	~2.9, ~1.8
Impedance (Ohm)	50
Polarisation	Linear
Radiation Pattern	Omni-Directional
Max. Input Power (W)	25

2JOB04-C885G

3G/2G/CELLULAR

Key Features ✓ High Performance ✓ Ground Plane Dependent ✓ Low Profile



General specification

Mounting type	Connector mount
Dimensions (mm)	48 × Ø 9
Operating temperature	-40 °C to +85 °C

Antenna and electrical specifications

3G/2G/CELLULAR

Standards	3G/Cellular/HSPA/UMTS/WCDA/ EDGE/EGPRS/GRPS/GSM/CDMA/2G
Frequency (MHz)	824-960, 1710-2170
VSWR	~2.4:1, ~2.6:1
Efficiency (%)	~68.3, ~50.1
Peak Gain (dBi)	~2.9, ~1.7
Impedance (Ohm)	50
Polarisation	Linear
Radiation Pattern	Omni-Directional
Max. Input Power (W)	25

2JW0304-C675B

3G/2G/CELLULAR

Key Features ✔ Low Profile ✔ Ground Plane Dependent ✔ Hinged Connector



White Black
Standard colors.
Other colors upon request.

General specification

Mounting type	Connector mount
Dimensions (mm)	113 × Ø 10
Operating temperature	-40 °C to +85 °C

Antenna and electrical specifications

3G/2G/CELLULAR

Standards	3G/Cellular/HSPA/UMTS/WCDA/ EDGE/EGPRS/GRPS/GSM/CDMA/2G
Frequency (MHz)	824-960, 1710-2170
VSWR	~2.1:1, ~1.6:1
Efficiency (%)	~30, ~59
Peak Gain (dBi)	~-1.3, ~2.0
Impedance (Ohm)	50
Polarisation	Linear
Radiation Pattern	Omni-Directional
Max. Input Power (W)	25

2J0801CF-C40G Active GNSS

GPS/GLONASS/BEIDOU/QZSS/Galileo/L1

Key Features ✔ Pre-Filter GNSS ✔ Low Power Consumption ✔ Ground Plane Dependent



White Black
Standard colors.
Other colors upon request.

General specification

Mounting type	Connector mount
Dimensions (mm)	Ø 13.2 × 70.4
Operating temperature	-40 °C to +85 °C

Antenna and electrical specifications

GPS/GLONASS/BEIDOU/QZSS/Galileo/L1

Standards	GPS(L1)/GLONASS(L10F)/BeiDou(B1)/ QZSS(L1)/Galileo(E1)
Frequency (MHz)	1561.098, 1575.42, 1598-1606
Impedance (Ohm)	50
Active Gain (dB)	28 @ 2.7 V
Voltage (V)	1.5 – 3.6
Current Consumption (mA)	9 @ 2.7 V
Power Consumption (mW)	24.3 Typ
Saw Filter Type	Pre-Filter
Out of Band Rejection (dB)	~43
ESD Protection (kV)	6

2J0801CF-C40G-A38G Active GNSS

GPS/GLONASS/BEIDOU/QZSS/Galileo/L1

Key Features ✔ Pre-Filter GNSS ✔ Low Power Consumption ✔ Ground Plane Dependent ✔ Right-Angle Connector



White Black
Standard colors.
Other colors upon request.

General specification

Mounting type	Connector mount
Dimensions (mm)	Ø 13.2 × 19 × 81.5
Operating temperature	-40 °C to +85 °C

Antenna and electrical specifications

GPS/GLONASS/BEIDOU/QZSS/Galileo/L1

Standards	GPS(L1)/GLONASS(L10F)/BeiDou(B1)/ QZSS(L1)/Galileo(E1)
Frequency (MHz)	1561.098, 1575.42, 1598-1606
Impedance (Ohm)	50
Active Gain (dB)	28 @ 2.7 V
Voltage (V)	1.5 – 3.6
Current Consumption (mA)	9 @ 2.7 V
Power Consumption (mW)	24.3 Typ
Saw Filter Type	Pre-Filter
Out of Band Rejection (dB)	~43
ESD Protection (kV)	6

2JW1001 Passive GNSS GPS/GLONASS/BEIDOU/QZSS/Galileo/L1

Key Features  High Efficiency  Ground Plane Dependent  Low Profile





General specification

Mounting type	Connector mount
Dimensions (mm)	∅ 10 × 71
Operating temperature	-20 °C to +85 °C

Antenna and electrical specifications GPS/GLONASS/BEIDOU/QZSS/Galileo/L1

Standards	GPS(L1)/GLONASS(L10F)/BeiDou(B1)/QZSS(L1)/Galileo(E1)
Frequency (MHz)	1561.098, 1575.42, 1598-1606
VSWR	~1.3:1, ~1.3:1, ~1.3:1
Efficiency (%)	~70, ~70, ~69
Peak Gain (dBi)	~2.9, ~2.8, ~2.9
Impedance (Ohm)	50
Polarisation	Linear
Radiation Pattern	Omni-Directional
Max. Input Power (W)	25

2J0102-2.4-C115N 2.4GHz/WiFi/LPWA/BT/ISM

Key Features  Low Profile  Ground Plane Dependent



General specification

Mounting type	Connector mount
Dimensions (mm)	∅ 9.5 × 56
Operating temperature	-40 °C to +85 °C

Antenna and electrical specifications 2.4GHz/WiFi/LPWA/BT/ISM

Standards	WiFi/Sigfox/LoRa/LPWA/Bluetooth/BLE/ZigBee/RFID/RFMA/ISM
Frequency (MHz)	2410-2490
VSWR	~2.2:1
Efficiency (%)	~68
Peak Gain (dBi)	~3.6
Impedance (Ohm)	50
Polarisation	Linear
Radiation Pattern	Omni-Directional
Max. Input Power (W)	25

2J0102-2.4-C366N 2.4GHz/WiFi/LPWA/BT/ISM

Key Features  Low Profile  Ground Plane Dependent  Right-Angle Connector



General specification

Mounting type	Connector mount
Dimensions (mm)	53 × 10 × 18
Operating temperature	-40 °C to +85 °C

Antenna and electrical specifications 2.4GHz/WiFi/LPWA/BT/ISM

Standards	WiFi/Sigfox/LoRa/LPWA/Bluetooth/BLE/ZigBee/RFID/RFMA/ISM
Frequency (MHz)	2410-2490
VSWR	~1.3:1
Efficiency (%)	~71
Peak Gain (dBi)	~3.2
Impedance (Ohm)	50
Polarisation	Linear
Radiation Pattern	Omni-Directional
Max. Input Power (W)	25

2J0A02-2.4-C151G

2.4GHz/WiFi/LPWA/BT/ISM

Key Features  Low Profile  High Efficiency  Ground Plane Dependent



General specification

Mounting type	Connector mount
Dimensions (mm)	Ø 9.6 × 44
Operating temperature	-40 °C to +85 °C

Antenna and electrical specifications 2.4GHz/WiFi/LPWA/BT/ISM

Standards	WiFi/Sigfox/LoRa/LPWA/Bluetooth/ BLE/ZigBee/RFID/RPMA/ISM
Frequency (MHz)	2410-2490
VSWR	~4.1:1
Efficiency (%)	~61
Peak Gain (dBi)	~3.5
Impedance (Ohm)	50
Polarisation	Linear
Radiation Pattern	Omni-Directional
Max. Input Power (W)	25

2J0702-2.4-C638r

2.4GHz/WiFi/LPWA/BT/ISM

Key Features  High Gain  Low Profile  Ground Plane Dependent



General specification

Mounting type	Connector mount
Dimensions (mm)	Ø 13.2 × 76.7
Operating temperature	-40 °C to +85 °C

Antenna and electrical specifications 2.4GHz/WiFi/LPWA/BT/ISM

Standards	WiFi/Sigfox/LoRa/LPWA/Bluetooth/ BLE/ZigBee/RFID/RPMA/ISM
Frequency (MHz)	2410-2490
VSWR	~1.8:1
Efficiency (%)	~52.2
Peak Gain (dBi)	~3.0
Impedance (Ohm)	50
Polarisation	Linear
Radiation Pattern	Omni-Directional
Max. Input Power (W)	25

2JW0302-2.4-C442B

2.4GHz/WiFi/LPWA/BT/ISM

Key Features  Low Profile  High Efficiency  Ground Plane Independent  Hinged Connector



General specification

Mounting type	Connector mount
Dimensions (mm)	113 × Ø 10
Operating temperature	-40 °C to +85 °C

Antenna and electrical specifications 2.4GHz/WiFi/LPWA/BT/ISM

Standards	WiFi/Sigfox/LoRa/LPWA/Bluetooth/ BLE/ZigBee/RFID/RPMA/ISM
Frequency (MHz)	2410-2490
VSWR	~1.9:1
Efficiency (%)	~62
Peak Gain (dBi)	~1.5
Impedance (Ohm)	50
Polarisation	Linear
Radiation Pattern	Omni-Directional
Max. Input Power (W)	25

2JW0402-2.4-C20N

2.4GHz/WiFi/LPWA/BT/ISM

Key Features  Ground Plane Dependent



Standard colors.
Other colors upon request.

General specification

Mounting type	Connector mount
Dimensions (mm)	∅ 10 × 139
Operating temperature	-40 °C to +85 °C

Antenna and electrical specifications

2.4GHz/WiFi/LPWA/BT/ISM

Standards	WiFi/Sigfox/LoRa/LPWA/Bluetooth/ BLE/ZigBee/RFID/PPMA/ISM
Frequency (MHz)	2410-2490
VSWR	~1.9:1
Efficiency (%)	~49.6
Peak Gain (dBi)	~2.2
Impedance (Ohm)	50
Polarisation	Linear
Radiation Pattern	Omni-Directional
Max. Input Power (W)	25

2JOA02-5.0-C151G

5.0GHz/WiFi/ISM

Key Features  High Efficiency  High Gain  Ground Plane Dependent  Low Profile



Standard colors.
Other colors upon request.

General specification

Mounting type	Connector mount
Dimensions (mm)	∅ 9.6 × 44
Operating temperature	-40 °C to +85 °C

Antenna and electrical specifications

5.0GHz/WiFi/ISM

Standards	WiFi/ISM
Frequency (MHz)	4920-5925
VSWR	~1.6:1
Efficiency (%)	~88
Peak Gain (dBi)	~5.3
Impedance (Ohm)	50
Polarisation	Linear
Radiation Pattern	Omni-Directional
Max. Input Power (W)	25

2JO102-C115N

2.4-5.0GHz/WiFi/LPWA/BT/ISM

Key Features  Low Profile  Ground Plane Dependent



Standard colors.
Other colors upon request.

General specification

Mounting type	Connector mount
Dimensions (mm)	∅ 9.5 × 56
Operating temperature	-40 °C to +85 °C

Antenna and electrical specifications

2.4-5.0GHz/WiFi/LPWA/BT/ISM

Standards	WiFi/Sigfox/LoRa/LPWA/Bluetooth/ BLE/ZigBee/RFID/PPMA/ISM
Frequency (MHz)	2410-2490, 4920-5925
VSWR	~1.4:1, ~1.7:1
Efficiency (%)	~60, ~83
Peak Gain (dBi)	~4.0, ~5.2
Impedance (Ohm)	50
Polarisation	Linear
Radiation Pattern	Omni-Directional
Max. Input Power (W)	25

2J0102-C366N

2.4-5.0GHz/WiFi/LPWA/BT/ISM

Key Features ✓ Low Profile ✓ High Gain ✓ Ground Plane Dependent ✓ Right-Angle Connector



White Black
Standard colors.
Other colors upon request.

General specification

Mounting type	Connector mount
Dimensions (mm)	53 × 10 × 18
Operating temperature	-40 °C to +85 °C

Antenna and electrical specifications 2.4-5.0GHz/WiFi/LPWA/BT/ISM

Standards	WiFi/Sigfox/LoRa/LPWA/Bluetooth/ BLE/ZigBee/RFID/MPMA/ISM
Frequency (MHz)	2410-2490, 4920-5925
VSWR	~1.4:1, ~1.7:1
Efficiency (%)	~60, ~83
Peak Gain (dBi)	~4.0, ~5.2
Impedance (Ohm)	50
Polarisation	Linear
Radiation Pattern	Omni-Directional
Max. Input Power (W)	25

2J0902-C115N

2.4-5.0GHz/WiFi/LPWA/BT/ISM

Key Features ✓ High Performance ✓ Ground Plane Independent



White Black
Standard colors.
Other colors upon request.

General specification

Mounting type	Connector mount
Dimensions (mm)	∅ 13 × 115
Operating temperature	-40 °C to +85 °C

Antenna and electrical specifications 2.4-5.0GHz/WiFi/LPWA/BT/ISM

Standards	WiFi/Sigfox/LoRa/LPWA/Bluetooth/ BLE/ZigBee/RFID/MPMA/ISM
Frequency (MHz)	2410-2490, 4920-5925
VSWR	~1.2:1, ~1.7:1
Efficiency (%)	~70.3, ~55.7
Peak Gain (dBi)	~2.0, ~2.2
Impedance (Ohm)	50
Polarisation	Linear
Radiation Pattern	Omni-Directional
Max. Input Power (W)	25

2J2202-C315N

2.4-5.0GHz/WiFi/LPWA/BT/ISM

Key Features ✓ High Gain ✓ Ground Plane Independent ✓ N-Male connector

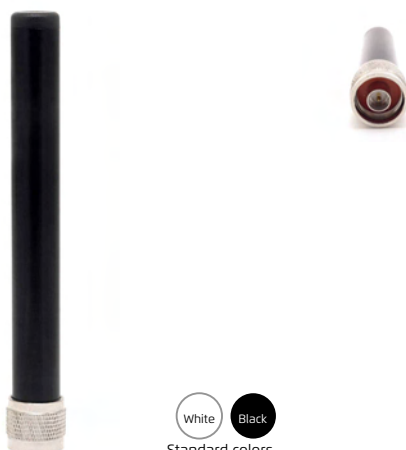

White Black
Standard colors.
Other colors upon request.

General specification

Mounting type	Connector mount
Dimensions (mm)	∅ 20 × 147
Operating temperature	-40 °C to +85 °C

Antenna and electrical specifications 2.4-5.0GHz/WiFi/LPWA/BT/ISM

Standards	WiFi/Sigfox/LoRa/LPWA/Bluetooth/ BLE/ZigBee/RFID/MPMA/ISM
Frequency (MHz)	2410-2490, 4920-5925
VSWR	~1.4:1, ~1.7:1
Efficiency (%)	~75.8, ~84.5
Peak Gain (dBi)	~4.1, ~3.9
Impedance (Ohm)	50
Polarisation	Linear
Radiation Pattern	Omni-Directional
Max. Input Power (W)	25

2JW0502-C115N

2.4-5.0GHz/WiFi/LPWA/BT/ISM

Key Features ✔ Low Profile ✔ Ground Plane Dependent



General specification

Mounting type	Connector mount
Dimensions (mm)	Ø 12.6 × 54.7
Operating temperature	-40 °C to +85 °C

Antenna and electrical specifications

2.4-5.0GHz/WiFi/LPWA/BT/ISM

Standards	WiFi/Sigfox/LoRa/LPWA/Bluetooth/ BLE/ZigBee/RFID/RPMA/ISM
Frequency (MHz)	2410-2490, 4920-5925
VSWR	~2.6:1, ~2.1:1
Efficiency (%)	~52.2, ~53.1
Peak Gain (dBi)	~2.8, ~2.4
Impedance (Ohm)	50
Polarisation	Linear
Radiation Pattern	Omni-Directional
Max. Input Power (W)	25

2JW1002

2.4-5.0GHz/WiFi/LPWA/BT/ISM

Key Features ✔ High Efficiency ✔ Ground Plane Dependent ✔ Low Profile



General specification

Mounting type	Connector mount
Dimensions (mm)	Ø 10 × 71
Operating temperature	-20 °C to +85 °C

Antenna and electrical specifications

2.4-5.0GHz/WiFi/LPWA/BT/ISM

Standards	WiFi/Sigfox/LoRa/LPWA/Bluetooth/ BLE/ZigBee/RFID/RPMA/ISM
Frequency (MHz)	2410-2490, 4920-5925
VSWR	~1.8:1, ~2.8:1
Efficiency (%)	~59, ~45
Peak Gain (dBi)	~3.0, ~1.0
Impedance (Ohm)	50
Polarisation	Linear
Radiation Pattern	Omni-Directional
Max. Input Power (W)	25

2JW1102 -C943B

2.4-5.0GHz/WiFi/LPWA/BT/ISM

Key Features ✔ High Performance ✔ Ground Plane Independent ✔ Hinged Connector



General specification

Mounting type	Connector mount
Dimensions (mm)	135 × 19 × 10
Operating temperature	-40 °C to +85 °C

Antenna and electrical specifications

2.4-5.0GHz/WiFi/LPWA/BT/ISM

Standards	WiFi/Sigfox/LoRa/LPWA/Bluetooth/ BLE/ZigBee/RFID/RPMA/ISM
Frequency (MHz)	2410-2490, 4920-5925
VSWR	~1.4:1, ~1.7:1
Efficiency (%)	~75.8, ~84.5
Peak Gain (dBi)	~4.1, ~3.9
Impedance (Ohm)	50
Polarisation	Linear
Radiation Pattern	Omni-Directional
Max. Input Power (W)	25

2JW1302-C442B

2.4-5.0GHz/WiFi/LPWA/BT/ISM

Key Features  Low Profile  Ground Plane Independent  Hinged Connector



General specification

Mounting type	Connector mount
Dimensions (mm)	Ø 10 × 71
Operating temperature	-20 °C to +85 °C



Antenna and electrical specifications

2.4-5.0GHz/WiFi/LPWA/BT/ISM

Standards	WiFi/Sigfox/LoRa/LPWA/Bluetooth/ BLE/ZigBee/RFID/RFMA/ISM
Frequency (MHz)	2410-2490, 4920-5925
VSWR	~2.1:1, ~2.8:1
Efficiency (%)	~35, ~60
Peak Gain (dBi)	~1.4, ~3.2
Impedance (Ohm)	50
Polarisation	Linear
Radiation Pattern	Omni-Directional
Max. Input Power (W)	25

2J0115-433-C20N

433MHz/LPWA/RFID/ZigBee/ISM

Key Features  Low Profile  Ground Plane Dependent



General specification

Mounting type	Connector mount
Dimensions (mm)	Ø 9.5 × 56
Operating temperature	-40 °C to +85 °C

Antenna and electrical specifications

433MHz/LPWA/RFID/ZigBee/ISM

Standards	Sigfox/LoRa/RFID/LPWA/ISM/UHF
Frequency (MHz)	433-435
VSWR	~1.8:1
Efficiency (%)	~36
Peak Gain (dBi)	~-2.4
Impedance (Ohm)	50
Polarisation	Linear
Radiation Pattern	Omni-Directional
Max. Input Power (W)	25

2J0115-433-C109N

433MHz/LPWA/RFID/ZigBee/ISM

Key Features  Low Profile  Ground Plane Dependent  Right-Angle Connector



General specification

Mounting type	Connector mount
Dimensions (mm)	53 × 10 × 18
Operating temperature	-40 °C to +85 °C

Antenna and electrical specifications

433MHz/LPWA/RFID/ZigBee/ISM

Standards	Sigfox/LoRa/RFID/LPWA/ISM/UHF
Frequency (MHz)	433-435
VSWR	~1.6:1
Efficiency (%)	~27
Peak Gain (dBi)	~-3.8
Impedance (Ohm)	50
Polarisation	Linear
Radiation Pattern	Omni-Directional
Max. Input Power (W)	25

2J0715-433-C708N

433MHz/LPWA/RFID/ZigBee/ISM

Key Features  Low Profile  Ground Plane Dependent



General specification

Mounting type	Connector mount
Dimensions (mm)	Ø 13.2 × 54.6
Operating temperature	-40 °C to +85 °C

Antenna and electrical specifications

433MHz/LPWA/RFID/ZigBee/ISM

Standards	Sigfox/LoRa/RFID/LPWA/ISM/UHF
Frequency (MHz)	433-435
VSWR	~1.6:1
Efficiency (%)	~50
Peak Gain (dBi)	~-1.1
Impedance (Ohm)	50
Polarisation	Linear
Radiation Pattern	Omni-Directional
Max. Input Power (W)	25

2JOB15-433-C884G

433MHz/LPWA/RFID/ZigBee/ISM

Key Features  Low Profile  Ground Plane Dependent  Right-Angle Connector



General specification

Mounting type	Connector mount
Dimensions (mm)	44 × 19.1 × 9
Operating temperature	-40 °C to +85 °C



Antenna and electrical specifications

433MHz/LPWA/RFID/ZigBee/ISM

Standards	Sigfox/LoRa/RFID/LPWA/ISM/UHF
Frequency (MHz)	433-435
VSWR	~1.4:1
Efficiency (%)	~41.7
Peak Gain (dBi)	~-1.2
Impedance (Ohm)	50
Polarisation	Linear
Radiation Pattern	Omni-Directional
Max. Input Power (W)	25

2JOB15-433-C885G

433MHz/LPWA/RFID/ZigBee/ISM

Key Features  Low Profile  Ground Plane Dependent



General specification

Mounting type	Connector mount
Dimensions (mm)	48 × Ø 9
Operating temperature	-40 °C to +85 °C

Antenna and electrical specifications

433MHz/LPWA/RFID/ZigBee/ISM

Standards	Sigfox/LoRa/RFID/LPWA/ISM/UHF
Frequency (MHz)	433-435
VSWR	~1.4:1
Efficiency (%)	~51.7
Peak Gain (dBi)	~-0.6
Impedance (Ohm)	50
Polarisation	Linear
Radiation Pattern	Omni-Directional
Max. Input Power (W)	25



2JW0315-433-C675B 433MHz/LPWA/Rfid/ZigBee/ISM

Key Features Low Profile Ground Plane Independent Hinged Connector



Standard colors.
Other colors upon request.

General specification

Mounting type	Connector mount
Dimensions (mm)	113 × Ø 10
Operating temperature	-40 °C to +85 °C

Antenna and electrical specifications 433MHz/LPWA/Rfid/ZigBee/ISM

Standards	Sigfox/LoRa/Rfid/LPWA/ISM/UHF
Frequency (MHz)	433-435
VSWR	~1.5:1
Efficiency (%)	~25
Peak Gain (dBi)	~-2.5
Impedance (Ohm)	50
Polarisation	Linear
Radiation Pattern	Omni-Directional
Max. Input Power (W)	25

2JW0415-433-C20N 433MHz/LPWA/Rfid/ZigBee/ISM

Key Features Ground Plane Dependent



Standard colors.
Other colors upon request.

General specification

Mounting type	Connector mount
Dimensions (mm)	Ø 10 × 139
Operating temperature	-40 °C to +85 °C

Antenna and electrical specifications 433MHz/LPWA/Rfid/ZigBee/ISM

Standards	Sigfox/LoRa/Rfid/LPWA/ISM/UHF
Frequency (MHz)	433-435
VSWR	~3.0:1
Efficiency (%)	~53
Peak Gain (dBi)	~-0.7
Impedance (Ohm)	50
Polarisation	Linear
Radiation Pattern	Omni-Directional
Max. Input Power (W)	35

2JW0415-433-C109N 433MHz/LPWA/Rfid/ZigBee/ISM

Key Features Ground Plane Dependent



Standard colors.
Other colors upon request.

General specification

Mounting type	Connector mount
Dimensions (mm)	138 × 10 × 18
Operating temperature	-40 °C to +85 °C

Antenna and electrical specifications 433MHz/LPWA/Rfid/ZigBee/ISM

Standards	Sigfox/LoRa/Rfid/LPWA/ISM/UHF
Frequency (MHz)	433-435
VSWR	~2.2:1
Efficiency (%)	~49
Peak Gain (dBi)	~-1.1
Impedance (Ohm)	50
Polarisation	Linear
Radiation Pattern	Omni-Directional
Max. Input Power (W)	35

2JW0715-433-C20N

433MHz/LPWA/RFID/ZigBee/ISM

Key Features  High Efficiency  Low Profile  Ground Plane Dependent



General specification

Mounting type	Connector mount
Dimensions (mm)	132 × Ø 12.6
Operating temperature	-40 °C to +85 °C

Antenna and electrical specifications

433MHz/LPWA/RFID/ZigBee/ISM

Standards	Sigfox/LoRa/RFID/LPWA/ISM/UHF
Frequency (MHz)	433-435
VSWR	~3.8:1
Efficiency (%)	~60
Peak Gain (dBi)	~-0.3
Impedance (Ohm)	50
Polarisation	Linear
Radiation Pattern	Omni-Directional
Max. Input Power (W)	25

2JW0815-433-C20N

433MHz/LPWA/RFID/ZigBee/ISM

Key Features  Low Profile  Ground Plane Dependent



General specification

Mounting type	Connector mount
Dimensions (mm)	137.3 × Ø 15.7
Operating temperature	-40 °C to +85 °C

Antenna and electrical specifications

433MHz/LPWA/RFID/ZigBee/ISM

Standards	Sigfox/LoRa/RFID/LPWA/ISM/UHF
Frequency (MHz)	433-435
VSWR	~2.5:1
Efficiency (%)	~50.3
Peak Gain (dBi)	~-0.5
Impedance (Ohm)	50
Polarisation	Linear
Radiation Pattern	Omni-Directional
Max. Input Power (W)	25

2J0115-868-C20N

868MHz/Sigfox/LoRa/LPWA/RFID/ZigBee/ISM

Key Features  Low Profile  Ground Plane Dependent



General specification

Mounting type	Connector mount
Dimensions (mm)	Ø 9.5 × 56
Operating temperature	-40 °C to +85 °C

Antenna and electrical specifications

868MHz/Sigfox/LoRa/LPWA/RFID/ZigBee/ISM

Standards	Sigfox/LoRa/ZigBee/RFID/LPWA/ISM/UHF
Frequency (MHz)	863-870
VSWR	~2.1:1
Efficiency (%)	~58
Peak Gain (dBi)	~-0.5
Impedance (Ohm)	50
Polarisation	Linear
Radiation Pattern	Omni-Directional
Max. Input Power (W)	25



2J0115-868-C109N

868MHz/Sigfox/LoRa/LPWA/RFID/ZigBee/ISM

Key Features Low Profile Ground Plane Dependent Right-Angle Connector



Standard colors.
Other colors upon request.

General specification

Mounting type	Connector mount
Dimensions (mm)	53 × 10 × 18
Operating temperature	-40 °C to +85 °C

Antenna and electrical specifications

868MHz/Sigfox/LoRa/LPWA/RFID/ZigBee/ISM

Standards	Sigfox/LoRa/ZigBee/RFID/LPWA/ISM/UHF
Frequency (MHz)	863-870
VSWR	~1.4:1
Efficiency (%)	~77.4
Peak Gain (dBi)	~1.3
Impedance (Ohm)	50
Polarisation	Linear
Radiation Pattern	Omni-Directional
Max. Input Power (W)	25

2JOB15-868-C884G

868MHz/Sigfox/LoRa/LPWA/RFID/ZigBee/ISM

Key Features Low Profile Ground Plane Dependent Right-Angle Connector



Standard colors.
Other colors upon request.



General specification

Mounting type	Connector mount
Dimensions (mm)	44 × 19.1 × 9
Operating temperature	-40 °C to +85 °C

Antenna and electrical specifications

868MHz/Sigfox/LoRa/LPWA/RFID/ZigBee/ISM

Standards	Sigfox/LoRa/ZigBee/RFID/LPWA/ISM/UHF
Frequency (MHz)	863-870
VSWR	~1.8:1
Efficiency (%)	~69.3
Peak Gain (dBi)	~1.2
Impedance (Ohm)	50
Polarisation	Linear
Radiation Pattern	Omni-Directional
Max. Input Power (W)	25

2JOB15-868-C885G

868MHz/Sigfox/LoRa/LPWA/RFID/ZigBee/ISM

Key Features Low Profile Ground Plane Dependent



Standard colors.
Other colors upon request.

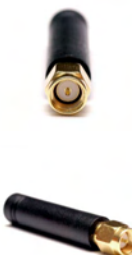

General specification

Mounting type	Connector mount
Dimensions (mm)	48 × Ø 9
Operating temperature	-40 °C to +85 °C

Antenna and electrical specifications

868MHz/Sigfox/LoRa/LPWA/RFID/ZigBee/ISM

Standards	Sigfox/LoRa/ZigBee/RFID/LPWA/ISM/UHF
Frequency (MHz)	863-870
VSWR	~2.2:1
Efficiency (%)	~63.5
Peak Gain (dBi)	~0.9
Impedance (Ohm)	50
Polarisation	Linear
Radiation Pattern	Omni-Directional
Max. Input Power (W)	25

2JW0315-868-C675B

868MHz/Sigfox/LoRa/LPWA/RFID/ZigBee/ISM

Key Features  Low Profile  Ground Plane Independent  Hinged Connector



Standard colors.
Other colors upon request.

General specification

Mounting type	Connector mount
Dimensions (mm)	113 × Ø 10
Operating temperature	-40 °C to +85 °C

Antenna and electrical specifications

868MHz/Sigfox/LoRa/LPWA/RFID/ZigBee/ISM

Standards	Sigfox/LoRa/ZigBee/RFID/LPWA/ISM/UHF
Frequency (MHz)	863-870
VSWR	~1.2:1
Efficiency (%)	~29
Peak Gain (dBi)	~-2.1
Impedance (Ohm)	50
Polarisation	Linear
Radiation Pattern	Omni-Directional
Max. Input Power (W)	25

2J0115-915-C20N

915MHz/Sigfox/LoRa/LPWA/RFID/ZigBee/ISM

Key Features  Low Profile  Ground Plane Dependent



Standard colors.
Other colors upon request.

General specification

Mounting type	Connector mount
Dimensions (mm)	Ø 9.5 × 56
Operating temperature	-40 °C to +85 °C



Antenna and electrical specifications

915MHz/Sigfox/LoRa/LPWA/RFID/ZigBee/ISM

Standards	Sigfox/LoRa/ZigBee/RFID/LPWA/ISM/UHF
Frequency (MHz)	902-928
VSWR	~2.5:1
Efficiency (%)	~62
Peak Gain (dBi)	~-0.6
Impedance (Ohm)	50
Polarisation	Linear
Radiation Pattern	Omni-Directional
Max. Input Power (W)	25

2J0115-915-C109N

915MHz/Sigfox/LoRa/LPWA/RFID/ZigBee/ISM

Key Features  Low Profile  Ground Plane Dependent  Right-Angle Connector



Standard colors.
Other colors upon request.

General specification

Mounting type	Connector mount
Dimensions (mm)	53 × 10 × 18
Operating temperature	-40 °C to +85 °C

Antenna and electrical specifications

915MHz/Sigfox/LoRa/LPWA/RFID/ZigBee/ISM

Standards	Sigfox/LoRa/ZigBee/RFID/LPWA/ISM/UHF
Frequency (MHz)	902-928
VSWR	~2.5:1
Efficiency (%)	~47
Peak Gain (dBi)	~-0.6
Impedance (Ohm)	50
Polarisation	Linear
Radiation Pattern	Omni-Directional
Max. Input Power (W)	25



2JOB15-915-C884G

915MHz/Sigfox/LoRa/LPWA/RFID/ZigBee/ISM

Key Features Low Profile Ground Plane Dependent Right-Angle Connector



General specification

Mounting type	Connector mount
Dimensions (mm)	44 × 19.1 × 9
Operating temperature	-40 °C to +85 °C

Antenna and electrical specifications

915MHz/Sigfox/LoRa/LPWA/RFID/ZigBee/ISM

Standards	Sigfox/LoRa/ZigBee/RFID/LPWA/ISM/UHF
Frequency (MHz)	902-928
VSWR	~1.6:1
Efficiency (%)	~60.4
Peak Gain (dBi)	~1.1
Impedance (Ohm)	50
Polarisation	Linear
Radiation Pattern	Omni-Directional
Max. Input Power (W)	25

2JOB15-915-C885G

915MHz/Sigfox/LoRa/LPWA/RFID/ZigBee/ISM

Key Features Low Profile Ground Plane Dependent



General specification

Mounting type	Connector mount
Dimensions (mm)	48 × Ø 9
Operating temperature	-40 °C to +85 °C

Antenna and electrical specifications

915MHz/Sigfox/LoRa/LPWA/RFID/ZigBee/ISM

Standards	Sigfox/LoRa/ZigBee/RFID/LPWA/ISM/UHF
Frequency (MHz)	902-928
VSWR	~2.4:1
Efficiency (%)	~57.6
Peak Gain (dBi)	~1.0
Impedance (Ohm)	50
Polarisation	Linear
Radiation Pattern	Omni-Directional
Max. Input Power (W)	25

2JW0315-915-C675B

915MHz/Sigfox/LoRa/LPWA/RFID/ZigBee/ISM

Key Features Low Profile Ground Plane Independent Hinged Connector



General specification

Mounting type	Connector mount
Dimensions (mm)	113 × Ø 10
Operating temperature	-40 °C to +85 °C



Antenna and electrical specifications

915MHz/Sigfox/LoRa/LPWA/RFID/ZigBee/ISM

Standards	Sigfox/LoRa/ZigBee/RFID/LPWA/ISM/UHF
Frequency (MHz)	902-928
VSWR	~1.5:1
Efficiency (%)	~25
Peak Gain (dBi)	~-2.5
Impedance (Ohm)	50
Polarisation	Linear
Radiation Pattern	Omni-Directional
Max. Input Power (W)	25

2JW0815-915-C20N

915MHz/Sigfox/LoRa/LPWA/RFID/ZigBee/ISM

Key Features  Low Profile  Ground Plane Dependent



General specification

Mounting type	Connector mount
Dimensions (mm)	137.3 × Ø 15.7
Operating temperature	-40 °C to +85 °C

Antenna and electrical specifications

915MHz/Sigfox/LoRa/LPWA/RFID/ZigBee/ISM

Standards	Sigfox/LoRa/ZigBee/RFID/LPWA/ISM/UHF
Frequency (MHz)	902-928
VSWR	~1.6:1
Efficiency (%)	~65.1
Peak Gain (dBi)	~2.1
Impedance (Ohm)	50
Polarisation	Linear
Radiation Pattern	Omni-Directional
Max. Input Power (W)	25

2JD0710-C728N

380-470MHz/LPWA/TETRA/UHF

Key Features  Ground Plane Independent  Dipole Antenna



General specification

Mounting type	Connector mount
Dimensions (mm)	Ø 13.6 × 138
Operating temperature	-40 °C to +85 °C

Antenna and electrical specifications

380-470MHz/LPWA/TETRA/UHF

Standards	TETRA/UHF/PMR/LMR
Frequency (MHz)	380-470
Impedance (Ohm)	50
Polarisation	Linear
Radiation Pattern	Omni-Directional
Max. Input Power (W)	25

2JW0489-C20B

470MHz/LPWA/Sigfox/LoRa

Key Features  High Performance  Ground Plane Dependent



General specification

Mounting type	Connector mount
Dimensions (mm)	Ø 10 × 139
Operating temperature	-40 °C to +85 °C

Antenna and electrical specifications

470MHz/LPWA/Sigfox/LoRa

Standards	Sigfox/LoRa/LPWA/UHF
Frequency (MHz)	470-510
VSWR	~1.5:1
Efficiency (%)	~82.8
Peak Gain (dBi)	~2.0
Impedance (Ohm)	50
Polarisation	Linear
Radiation Pattern	Omni-Directional
Max. Input Power (W)	35

2J0819-C708N

169MHz/ERMES/VHF

Key Features  Ground Plane Independent  Low Profile



Standard colors.
Other colors upon request.

General specification

Mounting type	Connector mount
Dimensions (mm)	Ø 13.2 × 70.4
Operating temperature	-40 °C to +85 °C

Antenna and electrical specifications

169MHz/ERMES/VHF	
Standards	169MHz/ERMES/VHF
Frequency (MHz)	169
VSWR	~2.5:1
Impedance (Ohm)	50
Polarisation	Linear
Radiation Pattern	Omni-Directional
Max. Input Power (W)	25

2JD0819-C728N

169MHz/ERMES/VHF

Key Features  Ground Plane Independent  Dipole Antenna



Standard colors.
Other colors upon request.

General specification

Mounting type	Connector mount
Dimensions (mm)	Ø 13.6 × 168
Operating temperature	-40 °C to +85 °C

Antenna and electrical specifications

169MHz/ERMES/VHF	
Standards	169MHz/ERMES/VHF
Frequency (MHz)	169
Impedance (Ohm)	50
Polarisation	Linear
Radiation Pattern	Omni-Directional
Max. Input Power (W)	25

2JW1126-C952B

IRIDIUM

Key Features  High Performance  Ground Plane Independent  High Gain at Low Elevation Angles  Hinged Connector



Standard colors.
Other colors upon request.

General specification

Mounting type	Connector mount
Dimensions (mm)	135 × 19 × 10
Operating temperature	-40 °C to +85 °C

Antenna and electrical specifications

IRIDIUM	
Standards	IRIDIUM
Frequency (MHz)	1616-1627
VSWR	~1.4:1
Efficiency (%)	~85.5
Peak Gain (dBi)	~2.5
Impedance (Ohm)	50
Polarisation	Linear
Radiation Pattern	Omni-Directional
Max. Input Power (W)	25

2JW1178-C952B

DECAWAVE

Key Features ✓ High Efficiency ✓ Ground Plane Independent



General specification

Mounting type	Connector mount
Dimensions (mm)	135 × 19 × 10
Operating temperature	-40 °C to +85 °C

Antenna and electrical specifications

DECAWAVE

Standards	DECAWAVE
Frequency (MHz)	3244-3744, 3328-4660, 4243-4743, 5980-6999
VSWR	~2.2:1, ~2.0:1, ~1.7:1, ~2.5:1
Efficiency (%)	~59.0, ~59.5, ~59.8, ~72.2
Peak Gain (dBi)	~2.8, ~3.3, ~2.8, ~2.5
Impedance (Ohm)	50
Polarisation	Linear
Radiation Pattern	Omni-Directional
Max. Input Power (W)	25

2JD0909-C728N

FM

Key Features ✓ Ground Plane Independent ✓ High Gain Dipole



General specification

Mounting type	Connector mount
Dimensions (mm)	∅ 13.6 × 258.5
Operating temperature	-40 °C to +85 °C

Antenna and electrical specifications

FM

Standards	FM
Frequency (MHz)	88-108
Impedance (Ohm)	75
Polarisation	Linear
Radiation Pattern	Omni-Directional

2JD0665-C728N

FM/DAB

Key Features ✓ Ground Plane Independent ✓ High Gain Dipole

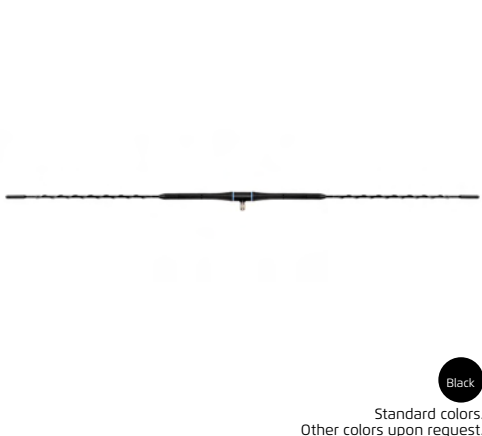

General specification

Mounting type	Connector mount
Dimensions (mm)	∅ 16 × 1074
Operating temperature	-40 °C to +85 °C

Antenna and electrical specifications

FM/DAB

Standards	FM, DAB
Frequency (MHz)	88-108, 174-240
Impedance (Ohm)	75
Polarisation	Linear
Radiation Pattern	Omni-Directional
Max. Input Power (W)	25

2JSPL01 FM-DAB Active Splitter

Key Features  FM & DAB (Digital audio broadcasting) Active Splitter  Certificates: IP67 - Water Resistant  Customizable Cables and Connectors



Black

Standard colors.
Other colors upon request.

General specification

Mounting type	Adhesive mount
Dimensions (mm)	54 × 51 × 11
Operating temperature	-40 °C to +85 °C
Certificates	IP67

Splitter Electrical specifications FM-DAB Active Splitter

Parameters	FM Output	DAB Output
Standards	FM	DAB
Frequency(MHz)	87.5-108	150-240
Impedance (Ohm)	50	50
Active Gain (dB)	27 dB Max.	27 dB Max.
Noise Figure (dB)	2 dB	2 dB
Phantom Power Supply	Yes	Yes
Current Consumption (mA)	typ. 35 mA	
Voltage (V)	12V DC phantom supply on RF Output, or 12V DC via red power cable	
Connector Type	DIN Male - Standard (Other Connectors Available)	SMB Female - Standard (Other Connectors Available)
Cable Length	30 cm Standard (Any Cable Length Available)	30 cm Standard (Any Cable Length Available)
Cable Type	D400 - Standard (Other Cables Available)	D400 - Standard (Other Cables Available)
RF Input		
Connector Type	DIN Female - Standard (Other Connectors Available)	
Cable Length	30 cm Standard (Any Cable Length Available)	
Cable Type	D400 - Standard (Other Cables Available)	
Power Supply		
Connector Type	None	
Cable Length	30 cm Standard (Any Cable Length Available)	
Cable Type	Red Wire AWG20	

2J2124-C681N

4GLTE/FirstNet/LPWA/NB-IoT/3G/2G

Key Features  N-Female connector  Ground Plane Independent



 
Standard colors.
Other colors upon request.

General specification

Mounting type	Screw mount
Dimensions (mm)	244 × Ø 22 (Ø 16)
Operating temperature	-40 °C to +85 °C

Antenna and electrical specifications

4GLTE/FirstNet/LPWA/NB-IoT/3G/2G

Standards	4GLTE/FirstNet/LPWA/ CAT-X/CAT-Mx/CAT-NBx/NB-IoT/3G/2G
Frequency (MHz)	698-960, 1710-2170, 2500-2700
VSWR	~1.8:1, ~1.5:1, ~2.0:1
Efficiency (%)	~55, ~58, ~71
Peak Gain (dBi)	~0.3, ~1.7, ~2.3
Impedance (Ohm)	50
Polarisation	Linear
Radiation Pattern	Omni-Directional
Max. Input Power (W)	25

2J6024B

4GLTE/FirstNet/LPWA/NB-IoT/3G/2G

Key Features  Low Profile  Ground Plane Independent  Customizable Cable and Connector  Certificates: IP67 - Water Resistant



 
Standard colors.
Other colors upon request.

General specification

Mounting type	Screw mount
Dimensions (mm)	80 × 74 × 14.7
Operating temperature	-40 °C to +85 °C
Thread Length options	8.5mm, 19mm (Default), 30mm
Certificates	IP67

Antenna and electrical specifications

4GLTE/FirstNet/LPWA/NB-IoT/3G/2G

Standards	4GLTE/FirstNet/LPWA/ CAT-X/CAT-Mx/CAT-NBx/NB-IoT/3G/2G
Frequency (MHz)	698-960, 1710-2170, 2500-2700
VSWR	~1.9:1, ~2.2:1, ~1.3:1
Efficiency (%)	~37.9, ~35.1, ~42.3
Peak Gain (dBi)	~1.8, ~3.5, ~4.4
Impedance (Ohm)	50
Polarisation	Linear
Radiation Pattern	Omni-Directional
Max. Input Power (W)	25

2J6A24B

4GLTE/FirstNet/LPWA/NB-IoT/3G/2G

Key Features  High Performance  Ground Plane Dependent  Customizable Cable and Connector  Anti-rotation Mounting
 Certificates: IP67 - Water Resistant, IP69 - Hot Water Pressure, IK09 - Impact Resistant



 
Standard colors.
Other colors upon request.

General specification

Mounting type	Screw mount
Dimensions (mm)	Ø 77.3 × 65.5
Operating temperature	-40 °C to +85 °C
Certificates	IP67, IP69, IK09

Antenna and electrical specifications

4GLTE/FirstNet/LPWA/NB-IoT/3G/2G

Standards	4GLTE/FirstNet/LPWA/ CAT-X/CAT-Mx/CAT-NBx/NB-IoT/3G/2G
Frequency (MHz)	698-960, 1710-2170, 2500-2700
VSWR	~2.1:1, ~1.5:1, ~1.5:1
Efficiency (%)	~52, ~62, ~50
Peak Gain (dBi)	~0.7, ~3.4, ~4.0
Impedance (Ohm)	50
Polarisation	Linear
Radiation Pattern	Omni-Directional
Max. Input Power (W)	25

2J7524B

4GLTE/FirstNet/LPWA/NB-IoT/3G/2G

- Key Features**
- ✔ Ground Plane Dependent
 - ✔ Customizable Cable and Connector
 - ✔ Certificates: IP67 - Water Resistant, IP69 - Hot Water Pressure
 - ✔ Anti-rotation Mounting



General specification

Mounting type	Screw mount
Dimensions (mm)	Ø 60 × 81
Operating temperature	-40 °C to +85 °C
Certificates	IP67, IP69

Antenna and electrical specifications

4GLTE/FirstNet/LPWA/NB-IoT/3G/2G

Standards	4GLTE/FirstNet/LPWA/ CAT-X/CAT-Mx/CAT-NBx/NB-IoT/3G/2G
Frequency (MHz)	698-960, 1710-2170, 2500-2700
VSWR	~2.1:1, ~1.6:1, ~1.5:1
Efficiency (%)	~56, ~51, ~43
Peak Gain (dBi)	~2.0, ~3.9, ~3.5
Impedance (Ohm)	50
Polarisation	Linear
Radiation Pattern	Omni-Directional
Max. Input Power (W)	25

2J7624B

4GLTE/FirstNet/LPWA/NB-IoT/3G/2G

- Key Features**
- ✔ High Performance
 - ✔ Ground Plane Independent
 - ✔ Customizable Cable and Connector
 - ✔ Certificates: IP67 - Water Resistant, IP69 - Hot Water Pressure



General specification

Mounting type	Screw mount
Dimensions (mm)	Ø 50 × 50.8
Operating temperature	-40 °C to +85 °C
Certificates	IP67, IP69

Antenna and electrical specifications

4GLTE/FirstNet/LPWA/NB-IoT/3G/2G

Standards	4GLTE/FirstNet/LPWA/ CAT-X/CAT-Mx/CAT-NBx/NB-IoT/3G/2G
Frequency (MHz)	698-960, 1710-2170, 2500-2700
VSWR	~2.1:1, ~1.8:1, ~2.5:1
Efficiency (%)	~56.4, ~56.1, ~37.8
Peak Gain (dBi)	~2.6, ~3.2, ~1.4
Impedance (Ohm)	50
Polarisation	Linear
Radiation Pattern	Omni-Directional
Max. Input Power (W)	25

2J7724B

4GLTE/FirstNet/LPWA/NB-IoT/3G/2G

- Key Features**
- ✔ High Performance
 - ✔ Ground Plane Dependent
 - ✔ Customizable Cable and Connector
 - ✔ Anti-rotation Mounting
 - ✔ Certificates: IP67 - Water Resistant, IP69 - Hot Water Pressure, IK09 - Impact Resistant

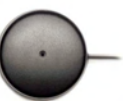

General specification

Mounting type	Screw mount
Dimensions (mm)	Ø 60 × 69
Operating temperature	-40 °C to +85 °C
Certificates	IP67, IP69, IK09





Antenna and electrical specifications

4GLTE/FirstNet/LPWA/NB-IoT/3G/2G

Standards	4GLTE/FirstNet/LPWA/ CAT-X/CAT-Mx/CAT-NBx/NB-IoT/3G/2G
Frequency (MHz)	698-960, 1710-2170, 2500-2700
VSWR	~1.9:1, ~1.2:1, ~1.4:1
Efficiency (%)	~66.9, ~74.5, ~58.9
Peak Gain (dBi)	~1.9, ~4.3, ~4.2
Impedance (Ohm)	50
Polarisation	Linear
Radiation Pattern	Omni-Directional
Max. Input Power (W)	25

2J9B24JBW-B11JW-B10BW

4GLTE/FirstNet/LPWA/NB-IoT/3G/2G

Key Features  High Performance  Ground Plane Independent  Customizable Cable and Connector
 Certificates: IP67 - Water Resistant, IP69 - Hot Water Pressure



 
 Standard colors.
 Other colors upon request.

General specification

Mounting type	Screw mount
Dimensions (mm)	110 × 76 × 253
Operating temperature	-40 °C to +85 °C
Certificates	IP67, IP69

Antenna and electrical specifications

4GLTE/FirstNet/LPWA/NB-IoT/3G/2G

Standards	4GLTE/FirstNet/LPWA/ CAT-X/CAT-Mx/CAT-NBx/NB-IoT/3G/2G
Frequency (MHz)	698-960, 1710-2170, 2500-2700
VSWR	~1.9:1, ~1.3:1, ~1.4:1
Efficiency (%)	~67.0, ~72.7, ~71.4
Peak Gain (dBi)	~1.7, ~3.5, ~3.1
Impedance (Ohm)	50
Polarisation	Linear
Radiation Pattern	Omni-Directional
Max. Input Power (W)	25

2J1204B

3G/2G/CELLULAR

Key Features  High Performance  Ground Plane Dependent  Customizable Cable and Connector  Certificates: IP67 - Water Resistant



 
 Standard colors.
 Other colors upon request.

General specification

Mounting type	Screw mount
Dimensions (mm)	∅ 29 × 66.3
Operating temperature	-40 °C to +85 °C
Certificates	IP67

Antenna and electrical specifications

3G/2G/CELLULAR

Standards	3G/Cellular/HSPA/UMTS/WCDA/ EDGE/EGPRS/GRPS/GSM/CDMA/2G
Frequency (MHz)	824-960, 1710-2170
VSWR	~1.7:1, ~2.2:1
Efficiency (%)	~60.6, ~41.5
Peak Gain (dBi)	~1.9, ~0.7
Impedance (Ohm)	50
Polarisation	Linear
Radiation Pattern	Omni-Directional
Max. Input Power (W)	100

2J1204Bz

3G/2G/CELLULAR

Key Features  High Performance  Ground Plane Dependent  Customizable Cable and Connector  Certificates: IP67 - Water Resistant



 
 Standard colors.
 Other colors upon request.



General specification

Mounting type	Screw mount
Dimensions (mm)	∅ 29 × 66.3
Operating temperature	-40 °C to +85 °C
Certificates	IP67

Antenna and electrical specifications

3G/2G/CELLULAR

Standards	3G/Cellular/HSPA/UMTS/WCDA/ EDGE/EGPRS/GRPS/GSM/CDMA/2G
Frequency (MHz)	824-960, 1710-2170
VSWR	~1.6:1, ~1.7:1
Efficiency (%)	~52.2, ~40.7
Peak Gain (dBi)	~1.3, ~0.6
Impedance (Ohm)	50
Polarisation	Linear
Radiation Pattern	Omni-Directional
Max. Input Power (W)	100

2J1504B 3G/2G/CELLULAR

Key Features ✓ High Performance ✓ Ground Plane Dependent ✓ Customizable Cable and Connector ✓ Certificates: IP67 - Water Resistant



General specification

Mounting type	Screw mount
Dimensions (mm)	Ø 29 x 231
Operating temperature	-40 °C to +85 °C
Certificates	IP67

Antenna and electrical specifications

3G/2G/CELLULAR	
Standards	3G/Cellular/HSPA/UMTS/WCDA/ EDGE/EGPRS/GRPS/GSM/CDMA/2G
Frequency (MHz)	824-960, 1710-2170
VSWR	~1.4:1, ~2.6:1
Efficiency (%)	~62.9, ~30.5
Peak Gain (dBi)	~3.5, ~-0.3
Impedance (Ohm)	50
Polarisation	Linear
Radiation Pattern	Omni-Directional
Max. Input Power (W)	100

2J1504Bz 3G/2G/CELLULAR

Key Features ✓ High Performance ✓ Ground Plane Dependent ✓ Customizable Cable and Connector ✓ Certificates: IP67 - Water Resistant



General specification

Mounting type	Screw mount
Dimensions (mm)	Ø 29 x 231
Operating temperature	-40 °C to +85 °C
Certificates	IP67

Antenna and electrical specifications

3G/2G/CELLULAR	
Standards	3G/Cellular/HSPA/UMTS/WCDA/ EDGE/EGPRS/GRPS/GSM/CDMA/2G
Frequency (MHz)	824-960, 1710-2170
VSWR	~1.5:1, ~2.1:1
Efficiency (%)	~62.9, ~30.5
Peak Gain (dBi)	~3.5, ~-0.3
Impedance (Ohm)	50
Polarisation	Linear
Radiation Pattern	Omni-Directional
Max. Input Power (W)	100

2J4704B 3G/2G/CELLULAR

Key Features ✓ Low Profile ✓ Ground Plane Independent ✓ Customizable Cable and Connector ✓ Certificates: IP69 - Hot Water Pressure



General specification

Mounting type	Screw mount
Dimensions (mm)	Ø 52 x 17.5
Operating temperature	-40 °C to +85 °C
Thread Length options	8.5mm, 19mm (Default), 30mm
Certificates	IP69

Antenna and electrical specifications

3G/2G/CELLULAR	
Standards	3G/Cellular/HSPA/UMTS/WCDA/ EDGE/EGPRS/GRPS/GSM/CDMA/2G
Frequency (MHz)	824-960, 1710-2170
VSWR	~1.5:1, ~2.1:1
Efficiency (%)	~29.7, ~17.4
Peak Gain (dBi)	~1.5, ~2.3
Impedance (Ohm)	50
Polarisation	Linear
Radiation Pattern	Omni-Directional
Max. Input Power (W)	100

2J6604B 3G/2G/CELLULAR

Key Features Low Profile Ground Plane Dependent Customizable Cable and Connector Anti-rotation Mounting
 Certificates: IP67 - Water Resistant, IP69 - Hot Water Pressure



General specification

Mounting type	Screw mount
Dimensions (mm)	Ø 77.3 × 15
Operating temperature	-40 °C to +85 °C
Certificates	IP67, IP69

Antenna and electrical specifications 3G/2G/CELLULAR

Standards	3G/Cellular/HSPA/UMTS/WCDA/ EDGE/EGPRS/GRPS/GSM/CDMA/2G
Frequency (MHz)	824-960, 1710-2170
VSWR	~2.8:1, ~1.8:1
Efficiency (%)	~20, ~25.6
Peak Gain (dBi)	~-2.8, ~0.1
Impedance (Ohm)	50
Polarisation	Linear
Radiation Pattern	Omni-Directional
Max. Input Power (W)	25

2J6704B 3G/2G/CELLULAR

Key Features Low Profile Ground Plane Dependent Customizable Cable and Connector Anti-rotation Mounting
 Certificates: IP67 - Water Resistant, IP69 - Hot Water Pressure, IK09 - Impact Resistant



General specification

Mounting type	Screw mount
Dimensions (mm)	Ø 77.3 × 36.5
Operating temperature	-40 °C to +85 °C
Certificates	IP67, IP69, IK09

Antenna and electrical specifications 3G/2G/CELLULAR

Standards	3G/Cellular/HSPA/UMTS/WCDA/ EDGE/EGPRS/GRPS/GSM/CDMA/2G
Frequency (MHz)	824-960, 1710-2170
VSWR	~3.0:1, ~2.0:1
Efficiency (%)	~18.1, ~20.5
Peak Gain (dBi)	~-4.1, ~-0.3
Impedance (Ohm)	50
Polarisation	Linear
Radiation Pattern	Omni-Directional
Max. Input Power (W)	100

2J4701BGF Active GNSS GPS/GLONASS/QZSS/Galileo/L1

Key Features Pre-Filter GNSS Ground Plane Independent Customizable Cable and Connector Certificates: IP69 - Hot Water Pressure



General specification

Mounting type	Screw mount
Dimensions (mm)	Ø 52 × 17.5
Operating temperature	-40 °C to +85 °C
Thread Length options	8.5mm, 19mm (Default), 30mm
Certificates	IP69

Antenna and electrical specifications GPS/GLONASS/QZSS/Galileo/L1

Standards	GPS(L1)/GLONASS(L10F)/QZSS(L1)/Galileo(E1)
Frequency (MHz)	1575.42, 1598-1606
VSWR	~1.4:1
Impedance (Ohm)	50
Radiation Pattern	Hemispherical
Polarisation	RHCP
Active Gain (dB)	28 @ 2.7 V
Voltage (V)	1.5 - 3.6
Current Consumption (mA)	9 @ 2.7 V
Power Consumption (mW)	24.3 Typ
Saw Filter Type	Pre-Filter
ESD Protection (kV)	6

2J7401BGF Active GNSS GPS/GLONASS/QZSS/Galileo/L1

- Key Features**  Pre-Filter GNSS  Ground Plane Independent  Customizable Cable and Connector  Certificates: IP67 - Water Resistant
 Anti-rotation Mounting



Standard colors.
Other colors upon request.







General specification

Mounting type	Screw mount
Dimensions (mm)	Ø 60 × 15,3
Operating temperature	-40 °C to +85 °C
Certificates	IP67

Antenna and electrical specifications GPS/GLONASS/QZSS/Galileo/L1

Standards	GPS(L1)/GLONASS(L10F)/QZSS(L1)/Galileo(E1)
Frequency (MHz)	1575.42, 1598-1606
VSWR	<1.2:1
Impedance (Ohm)	50
Radiation Pattern	Hemispherical
Polarisation	RHCP
Active Gain (dB)	26 @ 3V, 28 @ 5V
Voltage (V)	2.7 - 5.5
Current Consumption (mA)	15 - 25
Power Consumption (mW)	138 Max
Saw Filter Type	Pre-Filter

2J6933By Passive GNSS GPS/QZSS/Galileo/L1/IRIDIUM

- Key Features**  Single Feed Technology  Ground Plane Independent  Customizable Cable and Connector
 Certificates: IP67 - Water Resistant, IP69 - Hot Water Pressure



Standard colors.
Other colors upon request.





General specification

Mounting type	Screw mount
Dimensions (mm)	80 × 76 × 25,6
Operating temperature	-40 °C to +85 °C
Certificates	IP67, IP69

Antenna and electrical specifications GPS/QZSS/Galileo/L1/IRIDIUM

Standards	GPS(L1)/QZSS(L1)/Galileo(E1), IRIDIUM
Frequency (MHz)	1575.42, 1616-1627
VSWR	~1.1:1, ~1.3:1
Efficiency (%)	~93.8, ~92.9
Peak Gain (dBi)	~5.1, ~5.7
Impedance (Ohm)	50
Polarisation	RHCP
Radiation Pattern	Hemispherical

2J6901BC2F L1/L2 High Precision GNSS RTK Antenna GPS/GLONASS/BEIDOU/QZSS/Galileo/L1/L2

- Key Features**  Ground Plane Independent  Customizable Cable and Connector  Low Noise Figure  Low Power Consumption
 Certificates: IP67 - Water Resistant, IP69 - Hot Water Pressure  Pre-Filter GNSS



Standard colors.
Other colors upon request.



General specification

Mounting type	Screw mount
Dimensions (mm)	80 × 76 × 25,6
Operating temperature	-40 °C to +85 °C
Certificates	IP67, IP69

Antenna and electrical specifications GPS/GLONASS/BEIDOU/QZSS/Galileo/L1/L2

Technologies	GPS(L1,L2)/GLONASS(L10F)/BeiDou(B1)/QZSS(L1,L2)/Galileo(E1)
Frequency (MHz)	1227.6, 1561.09, 1575.42, 1602
Standards	GPS(L2C), QZSS(L2C), GPS(L1C), GLONASS(L10F), BeiDou(B1) QZSS(L1C), Galileo(E1), SBAS (L1)
Impedance (Ohm)	50
VSWR	~1.2:1, ~2.3:1
Efficiency (%)	~63.8, ~63.8
Active Gain (dB)	28 @ 3 V
Voltage (V)	2.3 - 6
Current Consumption (mA)	16 @ 3 V
Power Consumption (mW)	48 @ 3 V
Saw Filter Type	Pre-Filter
Polarisation	RHCP

2J6602B-2.4

2.4GHz/WiFi/LPWA/BT/ISM

Key Features  Low Profile  Ground Plane Dependent  Customizable Cable and Connector  Anti-rotation Mounting
 Certificates: IP67 - Water Resistant, IP69 - Hot Water Pressure



General specification

Mounting type	Screw mount
Dimensions (mm)	Ø 77.3 × 15
Operating temperature	-40 °C to +85 °C
Certificates	IP67, IP69





Antenna and electrical specifications

2.4GHz/WiFi/LPWA/BT/ISM

Standards	WiFi/Sigfox/LoRa/LPWA/Bluetooth/ BLE/ZigBee/RFID/RFMA/ISM
Frequency (MHz)	2410-2490
VSWR	~1.5:1
Efficiency (%)	~48.7
Peak Gain (dBi)	~4.9
Impedance (Ohm)	50
Polarisation	Linear
Radiation Pattern	Omni-Directional
Max. Input Power (W)	25

2J7402B-2.4

2.4GHz/WiFi/LPWA/BT/ISM

Key Features  Ground Plane Dependent  Customizable Cable and Connector  Certificates: IP67 - Water Resistant
 Anti-rotation Mounting



General specification

Mounting type	Screw mount
Dimensions (mm)	Ø 60 × 15.3
Operating temperature	-40 °C to +85 °C
Certificates	IP67

Antenna and electrical specifications

2.4GHz/WiFi/LPWA/BT/ISM

Standards	WiFi/Sigfox/LoRa/LPWA/Bluetooth/ BLE/ZigBee/RFID/RFMA/ISM
Frequency (MHz)	2410-2490
VSWR	~1.4:1
Efficiency (%)	~56.5
Peak Gain (dBi)	~3.8
Impedance (Ohm)	50
Polarisation	Linear
Radiation Pattern	Omni-Directional
Max. Input Power (W)	25

2J4702B

2.4-5.0GHz/WiFi/LPWA/BT/ISM

Key Features  Low Profile  Ground Plane Dependent  Customizable Cable and Connector  Certificates: IP69 - Hot Water Pressure



General specification

Mounting type	Screw mount
Dimensions (mm)	Ø 52 × 17.5
Operating temperature	-40 °C to +85 °C
Thread Length options	8.5mm, 19mm (Default), 30mm
Certificates	IP69





Antenna and electrical specifications

2.4-5.0GHz/WiFi/LPWA/BT/ISM

Standards	WiFi/Sigfox/LoRa/LPWA/Bluetooth/ BLE/ZigBee/RFID/RFMA/ISM
Frequency (MHz)	2410-2490, 4920-5925
VSWR	~1.6:1, ~1.7:1
Efficiency (%)	~28, ~28
Peak Gain (dBi)	~2.2, ~1.5
Impedance (Ohm)	50
Polarisation	Linear
Radiation Pattern	Omni-Directional
Max. Input Power (W)	25

2J6602B

2.4-5.0GHz/WiFi/LPWA/BT/ISM

Key Features  Low Profile  Ground Plane Independent  Customizable Cable and Connector  Anti-rotation Mounting
 Certificates: IP67 - Water Resistant, IP69 - Hot Water Pressure



Standard colors.
Other colors upon request.

General specification





Mounting type	Screw mount
Dimensions (mm)	Ø 77.3 × 15
Operating temperature	-40 °C to +85 °C
Certificates	IP67, IP69

Antenna and electrical specifications 2.4-5.0GHz/WiFi/LPWA/BT/ISM

Standards	WiFi/Sigfox/LoRa/LPWA/Bluetooth/ BLE/ZigBee/RFID/RFMA/ISM
Frequency (MHz)	2410-2490, 4920-5925
VSWR	~1.5:1, ~1.5:1
Efficiency (%)	~48.7, ~29.2
Peak Gain (dBi)	~4.9, ~4.5
Impedance (Ohm)	50
Polarisation	Linear
Radiation Pattern	Omni-Directional
Max. Input Power (W)	25

2J6702B

2.4-5.0GHz/WiFi/LPWA/BT/ISM

Key Features  Low Profile  Ground Plane Independent  Customizable Cable and Connector  Anti-rotation Mounting
 Certificates: IP67 - Water Resistant, IP69 - Hot Water Pressure, IK09 - Impact Resistant



Standard colors.
Other colors upon request.

General specification





Mounting type	Screw mount
Dimensions (mm)	Ø 77.3 × 36.5
Operating temperature	-40 °C to +85 °C
Certificates	IP67, IP69, IK09

Antenna and electrical specifications 2.4-5.0GHz/WiFi/LPWA/BT/ISM

Standards	WiFi/Sigfox/LoRa/LPWA/Bluetooth/ BLE/ZigBee/RFID/RFMA/ISM
Frequency (MHz)	2410-2490, 4920-5925
VSWR	~1.2:1, ~1.4:1
Efficiency (%)	~35, ~33
Peak Gain (dBi)	~4.3, ~1.8
Impedance (Ohm)	50
Polarisation	Linear
Radiation Pattern	Omni-Directional
Max. Input Power (W)	25

2J6A02B

2.4-5.0GHz/WiFi/LPWA/BT/ISM

Key Features  High Performance  Ground Plane Independent  Customizable Cable and Connector  Anti-rotation Mounting
 Certificates: IP67 - Water Resistant, IP69 - Hot Water Pressure, IK09 - Impact Resistant



Standard colors.
Other colors upon request.

General specification





Mounting type	Screw mount
Dimensions (mm)	Ø 77.3 × 65.5
Operating temperature	-40 °C to +85 °C
Certificates	IP67, IP69, IK09

Antenna and electrical specifications 2.4-5.0GHz/WiFi/LPWA/BT/ISM

Standards	WiFi/Sigfox/LoRa/LPWA/Bluetooth/ BLE/ZigBee/RFID/RFMA/ISM
Frequency (MHz)	2410-2490, 4920-5925
VSWR	~1.8:1, ~1.8:1
Efficiency (%)	~50.5, ~48
Peak Gain (dBi)	~2.6, ~4.4
Impedance (Ohm)	50
Polarisation	Linear
Radiation Pattern	Omni-Directional
Max. Input Power (W)	25

2J6515B-433

433MHz/LPWA/RFID/ZigBee/ISM

- Key Features**  Ground Plane Dependent  Customizable Cable and Connector  Anti-rotation Mounting
 Certificates: IP67 - Water Resistant, IP69 - Hot Water Pressure, IK09 - Impact Resistant



Standard colors.
Other colors upon request.

General specification





Mounting type	Screw mount
Dimensions (mm)	Ø 146 × 31.5
Operating temperature	-40 °C to +85 °C
Certificates	IP67, IP69, IK09

Antenna and electrical specifications 433MHz/LPWA/RFID/ZigBee/ISM

Standards	Sigfox/LoRa/RFID/LPWA/ISM/UHF
Frequency (MHz)	433-435
VSWR	~1.3:1
Efficiency (%)	~58.3
Peak Gain (dBi)	~2.9
Impedance (Ohm)	50
Polarisation	Linear
Radiation Pattern	Omni-Directional
Max. Input Power (W)	50

2J7515B-433

433MHz/LPWA/RFID/ZigBee/ISM

- Key Features**  Ground Plane Dependent  Customizable Cable and Connector  Anti-rotation Mounting
 Certificates: IP67 - Water Resistant, IP69 - Hot Water Pressure



Standard colors.
Other colors upon request.

General specification





Mounting type	Screw mount
Dimensions (mm)	Ø 60 × 81
Operating temperature	-40 °C to +85 °C
Certificates	IP67, IP69

Antenna and electrical specifications 433MHz/LPWA/RFID/ZigBee/ISM

Standards	Sigfox/LoRa/RFID/LPWA/ISM/UHF
Frequency (MHz)	433-435
VSWR	~1.4:1
Efficiency (%)	~41.9
Peak Gain (dBi)	~1.1
Impedance (Ohm)	50
Polarisation	Linear
Radiation Pattern	Omni-Directional
Max. Input Power (W)	25

2J7815B-433

433MHz/LPWA/RFID/ZigBee/ISM

- Key Features**  Ground Plane Dependent  Customizable Cable and Connector  Anti-rotation Mounting
 Certificates: IP67 - Water Resistant, IP69 - Hot Water Pressure



Standard colors.
Other colors upon request.

General specification

Mounting type	Screw mount
Dimensions (mm)	Ø 60 × 205
Operating temperature	-40 °C to +85 °C
Certificates	IP67, IP69

Antenna and electrical specifications 433MHz/LPWA/RFID/ZigBee/ISM

Standards	Sigfox/LoRa/RFID/LPWA/ISM/UHF
Frequency (MHz)	433-435
VSWR	~2.0:1
Efficiency (%)	~50
Peak Gain (dBi)	~-0.1
Impedance (Ohm)	50
Polarisation	Linear
Radiation Pattern	Omni-Directional
Max. Input Power (W)	50

2J1015B-868

868MHz/Sigfox/LoRa/LPWA/RFID/ZigBee/ISM

Key Features  Low Profile  Ground Plane Dependent  Customizable Cable and Connector



Standard colors.
Other colors upon request.

General specification

Mounting type	Screw mount
Dimensions (mm)	50 × Ø 16
Operating temperature	-40 °C to +85 °C

Antenna and electrical specifications

868MHz/Sigfox/LoRa/LPWA/RFID/ZigBee/ISM

Standards	Sigfox/LoRa/ZigBee/RFID/LPWA/ISM/UHF
Frequency (MHz)	863-870
VSWR	~1.4:1
Efficiency (%)	~37
Peak Gain (dBi)	~-0.3
Impedance (Ohm)	50
Polarisation	Linear
Radiation Pattern	Omni-Directional
Max. Input Power (W)	25

2J6015B-868

868MHz/Sigfox/LoRa/LPWA/RFID/ZigBee/ISM

Key Features  Low Profile  Ground Plane Dependent  Customizable Cable and Connector  Certificates: IP67 - Water Resistant



Standard colors.
Other colors upon request.

General specification

Mounting type	Screw mount
Dimensions (mm)	80 × 74 × 14.7
Operating temperature	-40 °C to +85 °C
Thread Length options	8.5mm, 19mm (Default), 30mm
Certificates	IP67



Antenna and electrical specifications

868MHz/Sigfox/LoRa/LPWA/RFID/ZigBee/ISM

Standards	Sigfox/LoRa/ZigBee/RFID/LPWA/ISM/UHF
Frequency (MHz)	863-870
VSWR	~1.1:1
Efficiency (%)	~57.6
Peak Gain (dBi)	~2.5
Impedance (Ohm)	50
Polarisation	Linear
Radiation Pattern	Omni-Directional
Max. Input Power (W)	25

2J6A15B-868

868MHz/Sigfox/LoRa/LPWA/RFID/ZigBee/ISM

Key Features  High Performance  Ground Plane Dependent  Customizable Cable and Connector  Anti-rotation Mounting
 Certificates: IP67 - Water Resistant, IP69 - Hot Water Pressure, IK09 - Impact Resistant



Standard colors.
Other colors upon request.

General specification

Mounting type	Screw mount
Dimensions (mm)	Ø 77.3 × 65.5
Operating temperature	-40 °C to +85 °C
Certificates	IP67, IP69, IK09

Antenna and electrical specifications

868MHz/Sigfox/LoRa/LPWA/RFID/ZigBee/ISM

Standards	Sigfox/LoRa/ZigBee/RFID/LPWA/ISM/UHF
Frequency (MHz)	863-870
VSWR	~1.3:1
Efficiency (%)	~61.8
Peak Gain (dBi)	~2.6
Impedance (Ohm)	50
Polarisation	Linear
Radiation Pattern	Omni-Directional
Max. Input Power (W)	25

2J7615B-868

868MHz/Sigfox/LoRa/LPWA/RFID/ZigBee/ISM

Key Features  Ground Plane Independent  Customizable Cable and Connector  Certificates: IP67 - Water Resistant, IP69 - Hot Water Pressure



White Black
Standard colors.
Other colors upon request.

General specification

Mounting type	Screw mount
Dimensions (mm)	Ø 50 × 50.8
Operating temperature	-40 °C to +85 °C
Certificates	IP67, IP69

Antenna and electrical specifications

868MHz/Sigfox/LoRa/LPWA/RFID/ZigBee/ISM

Standards	Sigfox/LoRa/ZigBee/RFID/LPWA/ISM/UHF
Frequency (MHz)	863-870
VSWR	~1.9:1
Efficiency (%)	~32.7
Peak Gain (dBi)	~-0.8
Impedance (Ohm)	50
Polarisation	Linear
Radiation Pattern	Omni-Directional
Max. Input Power (W)	25

2J1015B-915

915MHz/Sigfox/LoRa/LPWA/RFID/ZigBee/ISM

Key Features  Low Profile  Ground Plane Dependent  Customizable Cable and Connector



White Black
Standard colors.
Other colors upon request.

General specification

Mounting type	Screw mount
Dimensions (mm)	50 × Ø 16
Operating temperature	-40 °C to +85 °C



Antenna and electrical specifications

915MHz/Sigfox/LoRa/LPWA/RFID/ZigBee/ISM

Standards	Sigfox/LoRa/ZigBee/RFID/LPWA/ISM/UHF
Frequency (MHz)	902-928
VSWR	~1.9:1
Efficiency (%)	~38.7
Peak Gain (dBi)	~-0.2
Impedance (Ohm)	50
Polarisation	Linear
Radiation Pattern	Omni-Directional
Max. Input Power (W)	25

2J2115B-915

915MHz/Sigfox/LoRa/LPWA/RFID/ZigBee/ISM

Key Features  High Performance  Ground Plane Independent  Customizable Cable and Connector



White Black
Standard colors.
Other colors upon request.

General specification

Mounting type	Screw mount
Dimensions (mm)	220 × Ø 22 (Ø 16)
Operating temperature	-40 °C to +85 °C



Antenna and electrical specifications

915MHz/Sigfox/LoRa/LPWA/RFID/ZigBee/ISM

Standards	Sigfox/LoRa/ZigBee/RFID/LPWA/ISM/UHF
Frequency (MHz)	902-928
VSWR	~1.9:1
Efficiency (%)	~70.7
Peak Gain (dBi)	~3.1
Impedance (Ohm)	50
Polarisation	Linear
Radiation Pattern	Omni-Directional
Max. Input Power (W)	25

2J4715B-915

915MHz/Sigfox/LoRa/LPWA/RFID/ZigBee/ISM

Key Features  Low Profile  Ground Plane Independent  Customizable Cable and Connector  Certificates: IP69 - Hot Water Pressure



General specification

Mounting type	Screw mount
Dimensions (mm)	Ø 52 x 17,5
Operating temperature	-40 °C to +85 °C
Thread Length options	8.5mm, 19mm (Default), 30mm
Certificates	IP69

Antenna and electrical specifications

915MHz/Sigfox/LoRa/LPWA/RFID/ZigBee/ISM

Standards	Sigfox/LoRa/ZigBee/RFID/LPWA/ISM/UHF
Frequency (MHz)	902-928
VSWR	~1.4:1
Efficiency (%)	~37
Peak Gain (dBi)	~2.5
Impedance (Ohm)	50
Polarisation	Linear
Radiation Pattern	Omni-Directional
Max. Input Power (W)	25

2J6015B-915

915MHz/Sigfox/LoRa/LPWA/RFID/ZigBee/ISM

Key Features  Low Profile  Ground Plane Dependent  Customizable Cable and Connector  Certificates: IP67 - Water Resistant



General specification

Mounting type	Screw mount
Dimensions (mm)	80 x 74 x 14,7
Operating temperature	-40 °C to +85 °C
Thread Length options	8.5mm, 19mm (Default), 30mm
Certificates	IP67

Antenna and electrical specifications

915MHz/Sigfox/LoRa/LPWA/RFID/ZigBee/ISM

Standards	Sigfox/LoRa/ZigBee/RFID/LPWA/ISM/UHF
Frequency (MHz)	902-928
VSWR	~1.5:1
Efficiency (%)	~50.3
Peak Gain (dBi)	~1.9
Impedance (Ohm)	50
Polarisation	Linear
Radiation Pattern	Omni-Directional
Max. Input Power (W)	25

2J6615B-915

915MHz/Sigfox/LoRa/LPWA/RFID/ZigBee/ISM

Key Features  Low Profile  Ground Plane Dependent  Customizable Cable and Connector  Anti-rotation Mounting
  Certificates: IP67 - Water Resistant, IP69 - Hot Water Pressure



General specification

Mounting type	Screw mount
Dimensions (mm)	Ø 77,3 x 15
Operating temperature	-40 °C to +85 °C
Certificates	IP67, IP69





Antenna and electrical specifications

915MHz/Sigfox/LoRa/LPWA/RFID/ZigBee/ISM

Standards	Sigfox/LoRa/ZigBee/RFID/LPWA/ISM/UHF
Frequency (MHz)	902-928
VSWR	~1.5:1
Efficiency (%)	~33.5
Peak Gain (dBi)	~0.85
Impedance (Ohm)	50
Polarisation	Linear
Radiation Pattern	Omni-Directional
Max. Input Power (W)	25

2J6A15B-915

915MHz/Sigfox/LoRa/LPWA/RFID/ZigBee/ISM

Key Features  High Performance  Ground Plane Dependent  Customizable Cable and Connector  Anti-rotation Mounting
 Certificates: IP67 - Water Resistant, IP69 - Hot Water Pressure, IK09 - Impact Resistant



General specification

Mounting type	Screw mount
Dimensions (mm)	Ø 77.3 × 65.5
Operating temperature	-40 °C to +85 °C
Certificates	IP67, IP69, IK09

Antenna and electrical specifications 915MHz/Sigfox/LoRa/LPWA/RFID/ZigBee/ISM

Standards	Sigfox/LoRa/ZigBee/RFID/LPWA/ISM/UHF
Frequency (MHz)	902-928
VSWR	~1.41
Efficiency (%)	~66.8
Peak Gain (dBi)	~4.0
Impedance (Ohm)	50
Polarisation	Linear
Radiation Pattern	Omni-Directional
Max. Input Power (W)	25

2J7615B-915

915MHz/Sigfox/LoRa/LPWA/RFID/ZigBee/ISM

Key Features  Ground Plane Independent  Customizable Cable and Connector  Certificates: IP67 - Water Resistant, IP69 - Hot Water Pressure



General specification

Mounting type	Screw mount
Dimensions (mm)	Ø 50 × 50.8
Operating temperature	-40 °C to +85 °C
Certificates	IP67, IP69

Antenna and electrical specifications 915MHz/Sigfox/LoRa/LPWA/RFID/ZigBee/ISM

Standards	Sigfox/LoRa/ZigBee/RFID/LPWA/ISM/UHF
Frequency (MHz)	902-928
VSWR	~2.1:1
Efficiency (%)	~50.5
Peak Gain (dBi)	~2.5
Impedance (Ohm)	50
Polarisation	Linear
Radiation Pattern	Omni-Directional
Max. Input Power (W)	25

2J1310B

380-470MHz/LPWA/TETRA/UHF

Key Features  High Gain  Ground Plane Dependent  Customizable Cable and Connector



General specification

Mounting type	Screw mount
Dimensions (mm)	Ø 34 × 172
Operating temperature	-40 °C to +85 °C

Antenna and electrical specifications 380-470MHz/LPWA/TETRA/UHF

Standards	TETRA/UHF/PMR/LMR
Frequency (MHz)	380-470
VSWR	~2.3:1
Efficiency (%)	~80.6
Peak Gain (dBi)	~2.9
Impedance (Ohm)	50
Polarisation	Linear
Radiation Pattern	Omni-Directional
Max. Input Power (W)	25

2J7110B

380-470MHz/LPWA/TETRA/UHF

- Key Features**  High Gain  Ground Plane Dependent  Loaded Dipole  DC Grounded Antenna  Anti-rotation Mounting
 Certificates: IP67 - Water Resistant, IP69 - Hot Water Pressure, IK09 - Impact Resistant



 
 Standard colors.
 Other colors upon request.



General specification





Mounting type	Screw mount
Dimensions (mm)	Ø 96 × 130
Operating temperature	-40 °C to +85 °C
Certificates	IP67, IP69, IK09

Antenna and electrical specifications 380-470MHz/LPWA/TETRA/UHF

Standards	TETRA/UHF/PMR/LMR
Frequency (MHz)	380-470
VSWR	~1.5:1
Efficiency (%)	~73
Peak Gain (dBi)	~2.5
Impedance (Ohm)	50
Polarisation	Linear
Radiation Pattern	Omni-Directional
Max. Input Power (W)	25

2J8410B

380-470MHz/LPWA/TETRA/UHF

- Key Features**  Ground Plane Dependent  Customizable Cable and Connector  Certificates: IP67 - Water Resistant
 Anti-rotation Mounting



 
 Standard colors.
 Other colors upon request.

General specification





Mounting type	Screw mount
Dimensions (mm)	59.6 × 153.1 × 172.4
Operating temperature	-40 °C to +85 °C
Certificates	IP67

Antenna and electrical specifications 380-470MHz/LPWA/TETRA/UHF

Standards	TETRA/UHF/PMR/LMR
Frequency (MHz)	380-470
VSWR	~1.3:1
Efficiency (%)	~59.1
Peak Gain (dBi)	~2.2
Impedance (Ohm)	50
Polarisation	Linear
Radiation Pattern	Omni-Directional
Max. Input Power (W)	25

2J6726B iridium certified antenna

IRIDIUM

- Key Features**  Low Profile  Ground Plane Independent  Customizable Cable and Connector  Anti-rotation Mounting
 Certificates: IP67 - Water Resistant, IP69 - Hot Water Pressure, IK09 - Impact Resistant



 
 Standard colors.
 Other colors upon request.



General specification

Mounting type	Screw mount
Dimensions (mm)	Ø 77.3 × 36.5
Operating temperature	-40 °C to +85 °C
Certificates	IP67, IP69, IK09, Iridium Certified

Antenna and electrical specifications IRIDIUM

Standards	IRIDIUM
Frequency (MHz)	1616-1627
VSWR	~1.2:1
Efficiency (%)	~76
Peak Gain (dBi)	~4.5
Impedance (Ohm)	50
Polarisation	RHCP
Radiation Pattern	Hemispherical
Axial Ratio (dB)	3 Max

2J6926B

IRIDIUM

Key Features  Ground Plane Independent  Customizable Cable and Connector  Certificates: IP67 - Water Resistant, IP69 - Hot Water Pressure



 
Standard colors.
Other colors upon request.



General specification

Mounting type	Screw mount
Dimensions (mm)	80 × 76 × 25.6
Operating temperature	-40 °C to +85 °C
Certificates	IP67, IP69

Antenna and electrical specifications

IRIDIUM	
Standards	IRIDIUM
Frequency (MHz)	1616-1627
VSWR	~1.6:1
Efficiency (%)	~76.6
Peak Gain (dBi)	~4.5
Impedance (Ohm)	50
Polarisation	RHCP
Radiation Pattern	Hemispherical

2J9026JBW-C392N-B10BW iridium certified antenna

IRIDIUM

Key Features  High Performance  Ground Plane Independent  Customizable Cable and Connector  Certificates: IP67 - Water Resistant
 Marine Antenna  TNC Female Bulkhead Connector inside Antenna Housing



 
Standard colors.
Other colors upon request.



General specification

Mounting type	Screw mount
Dimensions (mm)	116 × 110 × 74
Operating temperature	-40 °C to +85 °C
Certificates	IP67

Antenna and electrical specifications

IRIDIUM	
Standards	IRIDIUM
Frequency (MHz)	1616-1627
VSWR	~1.2:1
Efficiency (%)	~76
Peak Gain (dBi)	~4.5
Impedance (Ohm)	50
Polarisation	RHCP
Radiation Pattern	Hemispherical
Axial Ratio (dB)	3 max

2J7213B

DAB/HDTV-DVBT

Key Features  Ground Plane Dependent  Customizable Cable and Connector  Certificates: IP67 - Water Resistant, IP69 - Hot Water Pressure
 Anti-rotation Mounting



 
Standard colors.
Other colors upon request.



General specification

Mounting type	Screw mount
Dimensions (mm)	∅ 60 × 100.5
Operating temperature	-40 °C to +85 °C
Certificates	IP67, IP69

Antenna and electrical specifications

DAB/HDTV-DVBT	
Standards	DAB/HDTV-DVBT
Frequency (MHz)	150-240, 440-870
VSWR	~3:1
Active Gain (dB)	23
Impedance (Ohm)	75
Polarisation	Linear
Radiation Pattern	Hemispherical
Power Consumption (mW)	390 max.
Voltage (V)	3.3-16
Current (mA)	13

2J5083P 5G Antenna

5G NR/4G LTE/FirstNet/CBRS/LPWA/3G/2G

Key Features Ground Plane Independent Customizable Cable and Connector



Standard colors.
Other colors upon request.

General specification

Mounting type	Adhesive mount
Dimensions (mm)	116 × 22 × 6.7
Operating temperature	-40 °C to +85 °C

Antenna and electrical specifications

5G NR/4G LTE/FirstNet/CBRS/LPWA/3G/2G

Standards	5G NR/4G LTE/FirstNet/CBRS/LPWA/ CAT-X/CAT-Mx/CAT-NBx/NB-IoT/3G/2G
Frequency (MHz)	617-960, 1427-2690, 3300-5000, 5150-5925
Bands	see 5G Bands list on page 17
VSWR	~1.5:1, ~1.7:1, ~1.8:1, ~1.5:1
Efficiency (%)	~60.1, ~45.8, ~24.5, ~24.5
Peak Gain (dBi)	~3.2, ~3.6, ~1.0, ~1.6
Impedance (Ohm)	50
Polarisation	Linear
Radiation Pattern	Omni-Directional
Max. Input Power (W)	35

2J4824P

4G LTE/FirstNet/LPWA/NB-IoT/3G/2G

Key Features Ground Plane Independent Customizable Cable and Connector Certificates: IP67 - Water Resistant, IP69 - Hot Water Pressure
 Optional Antenna Detection Resistor



Standard colors.
Other colors upon request.



General specification

Mounting type	Adhesive mount
Dimensions (mm)	83 × 35 × 13.3
Operating temperature	-40 °C to +85 °C
Certificates	IP67, IP69

Antenna and electrical specifications

4G LTE/FirstNet/LPWA/NB-IoT/3G/2G

Standards	4G LTE/FirstNet/LPWA/ CAT-X/CAT-Mx/CAT-NBx/NB-IoT/3G/2G
Frequency (MHz)	698-960, 1710-2170, 2500-2700
VSWR	~1.9:1, ~1.4:1, ~1.8:1
Efficiency (%)	~59, ~55, ~31
Peak Gain (dBi)	~3.4, ~2.1, ~1.0
Impedance (Ohm)	50
Polarisation	Linear
Radiation Pattern	Omni-Directional
Max. Input Power (W)	25

2J4924P

4G LTE/FirstNet/LPWA/NB-IoT/3G/2G

Key Features Ground Plane Independent Customizable Cable and Connector Certificates: IP67 - Water Resistant, IP69 - Hot Water Pressure
 High Performance Optional Antenna Detection Resistor



Standard colors.
Other colors upon request.



General specification

Mounting type	Adhesive mount
Dimensions (mm)	58.7 × 157.6 × 14.4
Operating temperature	-40 °C to +85 °C
Certificates	IP67, IP69

Antenna and electrical specifications

4G LTE/FirstNet/LPWA/NB-IoT/3G/2G

Standards	4G LTE/FirstNet/LPWA/ CAT-X/CAT-Mx/CAT-NBx/NB-IoT/3G/2G
Frequency (MHz)	698-960, 1710-2170, 2500-2700
VSWR	~1.7:1, ~1.4:1, ~1.5:1
Efficiency (%)	~76, ~69, ~76
Peak Gain (dBi)	~3.4, ~3.5, ~3.9
Impedance (Ohm)	50
Polarisation	Linear
Radiation Pattern	Omni-Directional
Max. Input Power (W)	25

2J5024P

4GLTE/FirstNet/LPWA/NB-IoT/3G/2G

Key Features ✔ Ground Plane Independent ✔ Customizable Cable and Connector ✔ Optional Antenna Detection Resistor



White Black
Standard colors.
Other colors upon request.

General specification

Mounting type	Adhesive mount
Dimensions (mm)	116 × 22 × 6.7
Operating temperature	-40 °C to +85 °C

Antenna and electrical specifications 4GLTE/FirstNet/LPWA/NB-IoT/3G/2G

Standards	4GLTE/FirstNet/LPWA/ CAT-X/CAT-Mx/CAT-NBx/NB-IoT/3G/2G
Frequency (MHz)	698-960, 1710-2170, 2500-2700
VSWR	~1.3:1, ~1.4:1, ~1.4:1
Efficiency (%)	~65, ~41, ~34
Peak Gain (dBi)	~3.0, ~2.2, ~4.0
Impedance (Ohm)	50
Polarisation	Linear
Radiation Pattern	Omni-Directional
Max. Input Power (W)	25

2J5124P

4GLTE/FirstNet/LPWA/NB-IoT/3G/2G

Key Features ✔ High Performance ✔ Ground Plane Independent ✔ Customizable Cable and Connector ✔ Flexible Housing ✔ Compact Size
✔ Optional Antenna Detection Resistor



White Black
Standard colors.
Other colors upon request.

General specification

Mounting type	Adhesive mount
Dimensions (mm)	122 × 14 × 6
Operating temperature	-40 °C to +85 °C

Antenna and electrical specifications 4GLTE/FirstNet/LPWA/NB-IoT/3G/2G

Standards	4GLTE/FirstNet/LPWA/ CAT-X/CAT-Mx/CAT-NBx/NB-IoT/3G/2G
Frequency (MHz)	698-960, 1710-2170, 2500-2700
VSWR	~2.0:1, ~1.5:1, ~1.8:1
Efficiency (%)	~53, ~52, ~41
Peak Gain (dBi)	~2.0, ~4.1, ~4.1
Impedance (Ohm)	50
Polarisation	Linear
Radiation Pattern	Omni-Directional
Max. Input Power (W)	25

2J5224P

4GLTE/FirstNet/LPWA/NB-IoT/3G/2G

Key Features ✔ High Performance ✔ Ground Plane Independent ✔ Customizable Cable and Connector ✔ Flexible Housing ✔ Compact Size
✔ Optional Antenna Detection Resistor



White Black
Standard colors.
Other colors upon request.



General specification

Mounting type	Adhesive mount
Dimensions (mm)	117.4 × 12.5 × 6.5
Operating temperature	-40 °C to +85 °C

Antenna and electrical specifications 4GLTE/FirstNet/LPWA/NB-IoT/3G/2G

Standards	4GLTE/FirstNet/LPWA/ CAT-X/CAT-Mx/CAT-NBx/NB-IoT/3G/2G
Frequency (MHz)	698-960, 1710-2170, 2500-2700
VSWR	~2.0:1, ~1.5:1, ~1.8:1
Efficiency (%)	~53, ~52, ~41
Peak Gain (dBi)	~2.0, ~4.1, ~4.1
Impedance (Ohm)	50
Polarisation	Linear
Radiation Pattern	Omni-Directional
Max. Input Power (W)	25

2J5424P

4G LTE/FirstNet/LPWA/NB-IoT/3G/2G

Key Features Ground Plane Independent Customizable Cable and Connector



Standard colors.
Other colors upon request.

General specification

Mounting type	Adhesive mount
Dimensions (mm)	112.5 × 60 × 11.3
Operating temperature	-40 °C to +85 °C

Antenna and electrical specifications 4G LTE/FirstNet/LPWA/NB-IoT/3G/2G

Standards	4G LTE/FirstNet/LPWA/ CAT-X/CAT-Mx/CAT-NBx/NB-IoT/3G/2G
Frequency (MHz)	698-960, 1710-2170, 2500-2700
VSWR	~2.7:1, ~2.1:1, ~2.0:1
Efficiency (%)	~44, ~49, ~48
Peak Gain (dBi)	~1.8, ~1.4, ~2.1
Impedance (Ohm)	50
Polarisation	Linear
Radiation Pattern	Omni-Directional
Max. Input Power (W)	25

2J4804P

3G/2G/CELLULAR

Key Features Ground Plane Independent Customizable Cable and Connector Certificates: IP67 - Water Resistant, IP69 - Hot Water Pressure
 Optional Antenna Detection Resistor



Standard colors.
Other colors upon request.

General specification

Mounting type	Adhesive mount
Dimensions (mm)	83 × 35 × 13.3
Operating temperature	-40 °C to +85 °C
Certificates	IP67, IP69

Antenna and electrical specifications 3G/2G/CELLULAR

Standards	3G/Cellular/HSPA/UMTS/WCDMA/ EDGE/EGPRS/GRPS/GSM/CDMA/2G
Frequency (MHz)	824-960, 1710-2170
VSWR	~1.4:1, ~1.3:1
Efficiency (%)	~61, ~55
Peak Gain (dBi)	~3.6, ~2.1
Impedance (Ohm)	50
Polarisation	Linear
Radiation Pattern	Omni-Directional
Max. Input Power (W)	25

2J5004PL

3G/2G/CELLULAR

Key Features Ground Plane Independent Customizable Cable and Connector



Standard colors.
Other colors upon request.

General specification

Mounting type	Adhesive mount
Dimensions (mm)	126.5 × 22 × 6.7
Operating temperature	-40 °C to +85 °C

Antenna and electrical specifications 3G/2G/CELLULAR

Standards	3G/Cellular/HSPA/UMTS/WCDMA/ EDGE/EGPRS/GRPS/GSM/CDMA/2G
Frequency (MHz)	824-960, 1710-2170
VSWR	~1.5:1, ~1.4:1
Efficiency (%)	~52, ~43
Peak Gain (dBi)	~3.5, ~4.6
Impedance (Ohm)	50
Polarisation	Linear
Radiation Pattern	Omni-Directional
Max. Input Power (W)	25

2J5504P 3G/2G/CELLULAR

Key Features Ground Plane Independent Customizable Cable and Connector



Standard colors.
Other colors upon request.

General specification

Mounting type	Adhesive mount
Dimensions (mm)	71 × 25 × 7
Operating temperature	-40 °C to +85 °C

Antenna and electrical specifications 3G/2G/CELLULAR

Standards	3G/Cellular/HSPA/UMTS/WCDA/ EDGE/EGPRS/GRPS/GSM/CDMA/2G
Frequency (MHz)	824-960, 1710-2170
VSWR	~1.3:1, ~1.9:1
Efficiency (%)	~56.7, ~34.2
Peak Gain (dBi)	~3.4, ~2.6
Impedance (Ohm)	50
Polarisation	Linear
Radiation Pattern	Omni-Directional
Max. Input Power (W)	25

2J6804P 3G/2G/CELLULAR

Key Features Ground Plane Dependent Customizable Cable and Connector For Metal Surfaces



Standard colors.
Other colors upon request.

General specification

Mounting type	Adhesive mount
Dimensions (mm)	117 × 49.5 × 38
Operating temperature	-40 °C to +85 °C

Antenna and electrical specifications 3G/2G/CELLULAR

Standards	3G/Cellular/HSPA/UMTS/WCDA/ EDGE/EGPRS/GRPS/GSM/CDMA/2G
Frequency (MHz)	824-960, 1710-2170
VSWR	~1.4:1, ~1.5:1
Efficiency (%)	~39, ~26
Peak Gain (dBi)	~0.7, ~0.2
Impedance (Ohm)	50
Polarisation	Linear
Radiation Pattern	Omni-Directional
Max. Input Power (W)	25

2J4802P 2.4-5.0GHz/WiFi/LPWA/BT/ISM

Key Features Ground Plane Independent Customizable Cable and Connector Certificates: IP67 - Water Resistant, IP69 - Hot Water Pressure



Standard colors.
Other colors upon request.

General specification

Mounting type	Adhesive mount
Dimensions (mm)	83 × 35 × 13.3
Operating temperature	-40 °C to +85 °C
Certificates	IP67, IP69

Antenna and electrical specifications 2.4-5.0GHz/WiFi/LPWA/BT/ISM

Standards	WiFi/Sigfox/LoRa/LPWA/Bluetooth/ BLE/ZigBee/RFID/RPMA/ISM
Frequency (MHz)	2410-2490, 4920-5925
VSWR	~1.3:1, ~1.3:1
Efficiency (%)	~49, ~28
Peak Gain (dBi)	~3.2, ~4.2
Impedance (Ohm)	50
Polarisation	Linear
Radiation Pattern	Omni-Directional
Max. Input Power (W)	25

2J5502P

2.4-5.0GHz/WiFi/LPWA/BT/ISM

Key Features ✓ Ground Plane Independent ✓ Customizable Cable and Connector



White Black
Standard colors.
Other colors upon request.

General specification

Mounting type	Adhesive mount
Dimensions (mm)	71 × 25 × 7
Operating temperature	-40 °C to +85 °C

Antenna and electrical specifications 2.4-5.0GHz/WiFi/LPWA/BT/ISM

Standards	WiFi/Sigfox/LoRa/LPWA/Bluetooth/ BLE/ZigBee/RFID/RFMA/ISM
Frequency (MHz)	2410-2490, 4920-5925
VSWR	~1.3:1, ~1.9:1
Efficiency (%)	~56.7, ~34.2
Peak Gain (dBi)	~3.4, ~2.6
Impedance (Ohm)	50
Polarisation	Linear
Radiation Pattern	Omni-Directional
Max. Input Power (W)	25

2J5115P-433

433MHz/LPWA/RFID/ZigBee/ISM

Key Features ✓ High Performance ✓ Ground Plane Independent ✓ Customizable Cable and Connector ✓ Flexible Housing ✓ Compact Size



White Black
Standard colors.
Other colors upon request.

General specification

Mounting type	Adhesive mount
Dimensions (mm)	122 × 14 × 6
Operating temperature	-40 °C to +85 °C

Antenna and electrical specifications 433MHz/LPWA/RFID/ZigBee/ISM

Standards	Sigfox/LoRa/RFID/LPWA/ISM/UHF
Frequency (MHz)	433-435
VSWR	~1.3:1
Efficiency (%)	~39.6
Peak Gain (dBi)	~1.7
Impedance (Ohm)	50
Polarisation	Linear
Radiation Pattern	Omni-Directional
Max. Input Power (W)	25

2J5215P-433

433MHz/LPWA/RFID/ZigBee/ISM

Key Features ✓ High Performance ✓ Ground Plane Independent ✓ Customizable Cable and Connector ✓ Flexible Housing ✓ Compact Size



White Black
Standard colors.
Other colors upon request.

General specification

Mounting type	Adhesive mount
Dimensions (mm)	117.4 × 12.5 × 6.5
Operating temperature	-40 °C to +85 °C

Antenna and electrical specifications 433MHz/LPWA/RFID/ZigBee/ISM

Standards	Sigfox/LoRa/RFID/LPWA/ISM/UHF
Frequency (MHz)	433-435
VSWR	~1.8:1
Efficiency (%)	~42.6
Peak Gain (dBi)	~1.5
Impedance (Ohm)	50
Polarisation	Linear
Radiation Pattern	Omni-Directional
Max. Input Power (W)	25

2J5415P-433

433MHz/LPWA/RFID/ZigBee/ISM

Key Features ✓ High Gain ✓ Ground Plane Independent ✓ Customizable Cable and Connector



Standard colors.
Other colors upon request.



General specification

Mounting type	Adhesive mount
Dimensions (mm)	60 × 112.5 × 11.3
Operating temperature	-40 °C to +85 °C

Antenna and electrical specifications 433MHz/LPWA/RFID/ZigBee/ISM

Standards	Sigfox/LoRa/RFID/LPWA/ISM/UHF
Frequency (MHz)	433-435
VSWR	~1.2:1
Efficiency (%)	~46.5
Peak Gain (dBi)	~2.4
Impedance (Ohm)	50
Polarisation	Linear
Radiation Pattern	Omni-Directional
Max. Input Power (W)	50

2J5115P-868

868MHz/Sigfox/LoRa/LPWA/RFID/ZigBee/ISM

Key Features ✓ High Performance ✓ Ground Plane Independent ✓ Customizable Cable and Connector ✓ Flexible Housing ✓ Compact Size



Standard colors.
Other colors upon request.

General specification

Mounting type	Adhesive mount
Dimensions (mm)	122 × 14 × 6
Operating temperature	-40 °C to +85 °C

Antenna and electrical specifications 868MHz/Sigfox/LoRa/LPWA/RFID/ZigBee/ISM

Standards	Sigfox/LoRa/ZigBee/RFID/LPWA/ISM/UHF
Frequency (MHz)	863-870
VSWR	~1.2:1
Efficiency (%)	~56.9
Peak Gain (dBi)	~2.5
Impedance (Ohm)	50
Polarisation	Linear
Radiation Pattern	Omni-Directional
Max. Input Power (W)	25

2J5215P-868

868MHz/Sigfox/LoRa/LPWA/RFID/ZigBee/ISM

Key Features ✓ High Performance ✓ Ground Plane Independent ✓ Customizable Cable and Connector ✓ Flexible Housing ✓ Compact Size



Standard colors.
Other colors upon request.



General specification

Mounting type	Adhesive mount
Dimensions (mm)	117.4 × 12.5 × 6.5
Operating temperature	-40 °C to +85 °C

Antenna and electrical specifications 868MHz/Sigfox/LoRa/LPWA/RFID/ZigBee/ISM

Standards	Sigfox/LoRa/ZigBee/RFID/LPWA/ISM/UHF
Frequency (MHz)	863-870
VSWR	~1.2:1
Efficiency (%)	~59.1
Peak Gain (dBi)	~2.6
Impedance (Ohm)	50
Polarisation	Linear
Radiation Pattern	Omni-Directional
Max. Input Power (W)	25

2J5115P-915

915MHz/Sigfox/LoRa/LPWA/RFID/ZigBee/ISM

Key Features ✓ High Performance ✓ Ground Plane Independent ✓ Customizable Cable and Connector ✓ Flexible Housing ✓ Compact Size



White Black
Standard colors.
Other colors upon request.

General specification

Mounting type	Adhesive mount
Dimensions (mm)	122 × 14 × 6
Operating temperature	-40 °C to +85 °C

Antenna and electrical specifications

915MHz/Sigfox/LoRa/LPWA/RFID/ZigBee/ISM

Standards	Sigfox/LoRa/ZigBee/RFID/LPWA/ISM/UHF
Frequency (MHz)	902-928
VSWR	~1.2:1
Efficiency (%)	~62.4
Peak Gain (dBi)	~3.4
Impedance (Ohm)	50
Polarisation	Linear
Radiation Pattern	Omni-Directional
Max. Input Power (W)	25

2J5215P-915

915MHz/Sigfox/LoRa/LPWA/RFID/ZigBee/ISM

Key Features ✓ High Performance ✓ Ground Plane Independent ✓ Customizable Cable and Connector ✓ Flexible Housing ✓ Compact Size



White Black
Standard colors.
Other colors upon request.



General specification

Mounting type	Adhesive mount
Dimensions (mm)	117.4 × 12.5 × 6.5
Operating temperature	-40 °C to +85 °C

Antenna and electrical specifications

915MHz/Sigfox/LoRa/LPWA/RFID/ZigBee/ISM

Standards	Sigfox/LoRa/ZigBee/RFID/LPWA/ISM/UHF
Frequency (MHz)	902-928
VSWR	~1.2:1
Efficiency (%)	~59.5
Peak Gain (dBi)	~3.0
Impedance (Ohm)	50
Polarisation	Linear
Radiation Pattern	Omni-Directional
Max. Input Power (W)	25

2J5410P

380-470MHz/LPWA/TETRA/UHF

Key Features ✓ High Gain ✓ Ground Plane Independent ✓ Customizable Cable and Connector



White Black
Standard colors.
Other colors upon request.



General specification

Mounting type	Adhesive mount
Dimensions (mm)	60 × 112.5 × 11.3
Operating temperature	-40 °C to +85 °C

Antenna and electrical specifications

380-470MHz/LPWA/TETRA/UHF

Standards	TETRA/UHF/PMR/LMR
Frequency (MHz)	380-470
VSWR	~2.0:1
Efficiency (%)	~45
Peak Gain (dBi)	~28
Impedance (Ohm)	50
Polarisation	Linear
Radiation Pattern	Omni-Directional
Max. Input Power (W)	50

2J6026P iridium certified antenna IRIDIUM

Key Features  High Performance  Ground Plane Independent  Customizable Cable and Connector  Low Profile



Standard colors.
Other colors upon request.

General specification

Mounting type	Adhesive mount
Dimensions (mm)	80 × 76 × 16
Operating temperature	-40 °C to +85 °C

Antenna and electrical specifications

IRIDIUM	
Standards	IRIDIUM
Frequency (MHz)	1616-1627
VSWR	~1.2:1
Efficiency (%)	~76
Peak Gain (dBi)	~4.5
Impedance (Ohm)	50
Polarisation	RHCP
Radiation Pattern	Hemispherical
Axial Ratio (dB)	3 max

2J3683M 5G Antenna

5G NR/4G LTE/FirstNet/CBRS/LPWA/3G/2G

Key Features ✔ High Performance ✔ Ground Plane Dependent ✔ Customizable Cable and Connector



General specification

Mounting type	Magnetic mount
Dimensions (mm)	Ø 31 × 109
Operating temperature	-40 °C to +85 °C

Antenna and electrical specifications

5G NR/4G LTE/FirstNet/CBRS/LPWA/3G/2G

Standards	5G NR/4G LTE/FirstNet/CBRS/LPWA/ CAT-X/CAT-Mx/CAT-NBx/NB-IoT/3G/2G
Frequency (MHz)	617-960, 1427-2690, 3300-5000, 5150-5925
Bands	see 5G Bands list on page 17
VSWR	~1.8:1, ~1.9:1, ~2.6:1, ~2.8:1
Efficiency (%)	~60.5, ~54.6, ~27.7, ~23.1
Peak Gain (dBi)	~1.0, ~2.9, ~2.5, ~0.4
Impedance (Ohm)	50
Polarisation	Linear
Radiation Pattern	Omni-Directional
Max. Input Power (W)	35

2J3024M

4G LTE/FirstNet/LPWA/NB-IoT/3G/2G

Key Features ✔ High Performance ✔ Ground Plane Dependent ✔ Customizable Cable and Connector



General specification

Mounting type	Magnetic mount
Dimensions (mm)	Ø 31 × 72
Operating temperature	-40 °C to +85 °C

Antenna and electrical specifications

4G LTE/FirstNet/LPWA/NB-IoT/3G/2G

Standards	4G LTE/FirstNet/LPWA/ CAT-X/CAT-Mx/CAT-NBx/NB-IoT/3G/2G
Frequency (MHz)	698-960, 1710-2170, 2500-2700
VSWR	~1.9:1, ~1.5:1, ~1.3:1
Efficiency (%)	~47, ~39, ~36
Peak Gain (dBi)	~1.0, ~2.4, ~2.1
Impedance (Ohm)	50
Polarisation	Linear
Radiation Pattern	Omni-Directional
Max. Input Power (W)	35

2J3624M

4G LTE/FirstNet/LPWA/NB-IoT/3G/2G

Key Features ✔ High Performance ✔ Ground Plane Dependent ✔ Customizable Cable and Connector



General specification

Mounting type	Magnetic mount
Dimensions (mm)	Ø 31 × 94
Operating temperature	-40 °C to +85 °C

Antenna and electrical specifications

4G LTE/FirstNet/LPWA/NB-IoT/3G/2G

Standards	4G LTE/FirstNet/LPWA/ CAT-X/CAT-Mx/CAT-NBx/NB-IoT/3G/2G
Frequency (MHz)	698-960, 1710-2170, 2500-2700
VSWR	~1.7:1, ~1.7:1, ~1.8:1
Efficiency (%)	~69.5, ~54.3, ~51.1
Peak Gain (dBi)	~2.2, ~2.2, ~2.7
Impedance (Ohm)	50
Polarisation	Linear
Radiation Pattern	Omni-Directional
Max. Input Power (W)	35

2J3924M 4GLTE/FirstNet/LPWA/NB-IoT/3G/2G

Key Features ✔ High Performance ✔ Ground Plane Dependent ✔ Customizable Cable and Connector



General specification

Mounting type	Magnetic mount
Dimensions (mm)	Ø 31 × 91
Operating temperature	-40 °C to +85 °C

Antenna and electrical specifications 4GLTE/FirstNet/LPWA/NB-IoT/3G/2G

Standards	4GLTE/FirstNet/LPWA/ CAT-X/CAT-Mx/CAT-NBx/NB-IoT/3G/2G
Frequency (MHz)	698-960, 1710-2170, 2500-2700
VSWR	~1.7:1, ~2.2:1, ~1.9:1
Efficiency (%)	~60.1, ~29.0, ~33.5
Peak Gain (dBi)	~1.8, ~1.1, ~2.8
Impedance (Ohm)	50
Polarisation	Linear
Radiation Pattern	Omni-Directional
Max. Input Power (W)	35

2J6024M 4GLTE/FirstNet/LPWA/NB-IoT/3G/2G

Key Features ✔ Low Profile ✔ Ground Plane Independent ✔ Customizable Cable and Connector

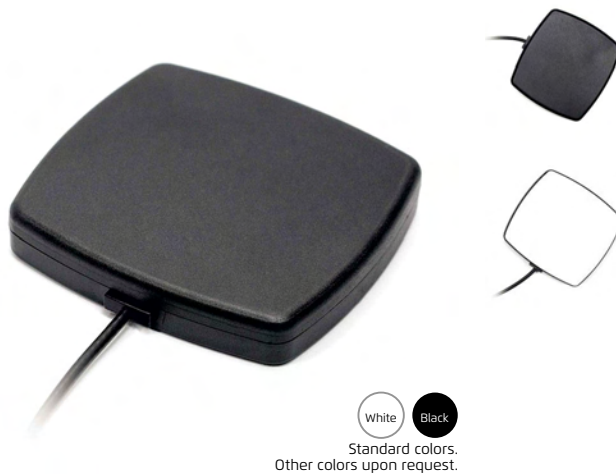

General specification

Mounting type	Magnetic mount
Dimensions (mm)	80 × 76 × 13
Operating temperature	-40 °C to +85 °C

Antenna and electrical specifications 4GLTE/FirstNet/LPWA/NB-IoT/3G/2G

Standards	4GLTE/FirstNet/LPWA/ CAT-X/CAT-Mx/CAT-NBx/NB-IoT/3G/2G
Frequency (MHz)	698-960, 1710-2170, 2500-2700
VSWR	~2.2:1, ~2.6:1, ~2.1:1
Efficiency (%)	~25.3, ~20.2, ~36.1
Peak Gain (dBi)	~-0.7, ~1.7, ~4.4
Impedance (Ohm)	50
Polarisation	Linear
Radiation Pattern	Omni-Directional
Max. Input Power (W)	25

2J7524M 4GLTE/FirstNet/LPWA/NB-IoT/3G/2G

Key Features ✔ High Performance ✔ Ground Plane Dependent ✔ Customizable Cable and Connector
✔ Certificates: IP67 - Water Resistant, IP69 - Hot Water Pressure



General specification

Mounting type	Magnetic mount
Dimensions (mm)	Ø 54 × 80
Operating temperature	-40 °C to +85 °C
Certificates	IP67, IP69

Antenna and electrical specifications 4GLTE/FirstNet/LPWA/NB-IoT/3G/2G

Standards	4GLTE/FirstNet/LPWA/ CAT-X/CAT-Mx/CAT-NBx/NB-IoT/3G/2G
Frequency (MHz)	698-960, 1710-2170, 2500-2700
VSWR	~2.1:1, ~1.6:1, ~1.5:1
Efficiency (%)	~56, ~51, ~43
Peak Gain (dBi)	~2.0, ~3.9, ~3.5
Impedance (Ohm)	50
Polarisation	Linear
Radiation Pattern	Omni-Directional
Max. Input Power (W)	25

2J7724M

4GLTE/FirstNet/LPWA/NB-IoT/3G/2G

- Key Features** ✓ High Performance ✓ Ground Plane Dependent ✓ Customizable Cable and Connector
 ✓ Certificates: IP67 - Water Resistant, IP69 - Hot Water Pressure, IK09 - Impact Resistant



General specification

Mounting type	Magnetic mount
Dimensions (mm)	Ø 54 × 68.2
Operating temperature	-40 °C to +85 °C
Certificates	IP67, IP69, IK09

Antenna and electrical specifications 4GLTE/FirstNet/LPWA/NB-IoT/3G/2G

Standards	4GLTE/FirstNet/LPWA/ CAT-X/CAT-Mx/CAT-NBx/NB-IoT/3G/2G
Frequency (MHz)	698-960, 1710-2170, 2500-2700
VSWR	~1.9:1, ~1.2:1, ~1.4:1
Efficiency (%)	~60.1, ~68.0, ~56.4
Peak Gain (dBi)	~1.8, ~3.1, ~2.9
Impedance (Ohm)	50
Polarisation	Linear
Radiation Pattern	Omni-Directional
Max. Input Power (W)	25

2JW0124-C868B-B02Ma

4GLTE/FirstNet/LPWA/NB-IoT/3G/2G

- Key Features** ✓ High Performance ✓ Ground Plane Independent ✓ Customizable Cable and Connector



General specification

Mounting type	Magnetic mount
Dimensions (mm)	Ø 54 × 219
Operating temperature	-40 °C to +85 °C

Antenna and electrical specifications 4GLTE/FirstNet/LPWA/NB-IoT/3G/2G

Standards	4GLTE/FirstNet/LPWA/ CAT-X/CAT-Mx/CAT-NBx/NB-IoT/3G/2G
Frequency (MHz)	698-960, 1710-2170, 2500-2700
VSWR	~1.6:1, ~1.4:1, ~2.0:1
Efficiency (%)	~69.6, ~61.4, ~37.0
Peak Gain (dBi)	~1.6, ~2.6, ~1.1
Impedance (Ohm)	50
Polarisation	Linear
Radiation Pattern	Omni-Directional
Max. Input Power (W)	35

2J3104M

3G/2G/CELLULAR

- Key Features** ✓ Ground Plane Dependent ✓ Customizable Cable and Connector



General specification

Mounting type	Magnetic mount
Dimensions (mm)	Ø 31 × 248.4
Operating temperature	-40 °C to +85 °C

Antenna and electrical specifications 3G/2G/CELLULAR

Standards	3G/Cellular/HSPA/UMTS/WCDMA/ EDGE/EGPRS/GRPS/GSM/CDMA/2G
Frequency (MHz)	824-960, 1710-2170
VSWR	~1.6:1, ~1.5:1
Efficiency (%)	~48.6, ~34.5
Peak Gain (dBi)	~2.2, ~3.0
Impedance (Ohm)	50
Polarisation	Linear
Radiation Pattern	Omni-Directional
Max. Input Power (W)	25

2J3704M 3G/2G/CELLULAR

Key Features ✓ Ground Plane Dependent ✓ Customizable Cable and Connector ✓ Low Profile



General specification

Mounting type	Magnetic mount
Dimensions (mm)	∅ 31 × 71.5
Operating temperature	-40 °C to +85 °C

Antenna and electrical specifications 3G/2G/CELLULAR

Standards	3G/Cellular/HSPA/UMTS/WCDA/ EDGE/EGPRS/GRPS/GSM/CDMA/2G
Frequency (MHz)	824-960, 1710-2170
VSWR	~1.6:1, ~1.8:1
Efficiency (%)	~49, ~28
Peak Gain (dBi)	~1.7, ~0.3
Impedance (Ohm)	50
Polarisation	Linear
Radiation Pattern	Omni-Directional
Max. Input Power (W)	25

2J6033My Passive GNSS GPS/QZSS/Galileo/L1/IRIDIUM

Key Features ✓ Low Profile ✓ Ground Plane Independent ✓ Single Feed Technology ✓ Customizable Cable and Connector

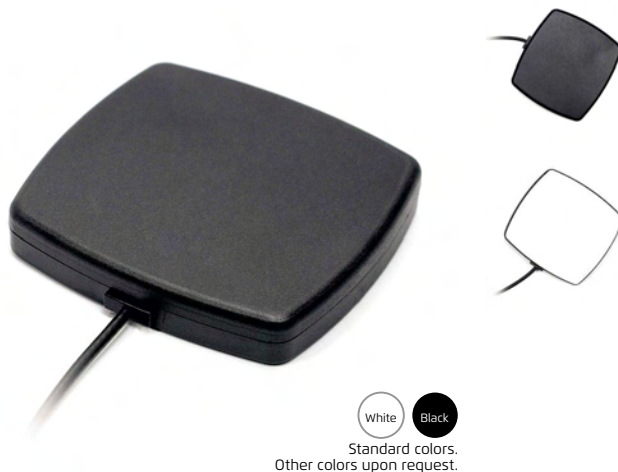

General specification

Mounting type	Magnetic mount
Dimensions (mm)	80 × 76 × 13
Operating temperature	-40 °C to +85 °C

Antenna and electrical specifications GPS/QZSS/Galileo/L1/IRIDIUM

Standards	GPS(L1)/QZSS(L1)/Galileo(E1), IRIDIUM
Frequency (MHz)	1575.42, 1616-1627
VSWR	~1.1:1, ~1.3:1
Efficiency (%)	~93.8, ~92.9
Peak Gain (dBi)	~5.1, ~5.7
Impedance (Ohm)	50
Polarisation	RHCP
Radiation Pattern	Hemispherical

2J7433My Passive GNSS GPS/QZSS/Galileo/L1/IRIDIUM

Key Features ✓ Single Feed Technology ✓ Ground Plane Independent ✓ Customizable Cable and Connector
✓ Certificates: IP67 - Water Resistant, IP69 - Hot Water Pressure



General specification







Mounting type	Magnetic mount
Dimensions (mm)	∅ 54 × 14.7
Operating temperature	-40 °C to +85 °C
Certificates	IP67, IP69

Antenna and electrical specifications GPS/QZSS/Galileo/L1/IRIDIUM

Standards	GPS(L1)/QZSS(L1)/Galileo(E1), IRIDIUM
Frequency (MHz)	1575.42, 1616-1627
VSWR	~1.6:1, ~1.5:1
Efficiency (%)	~66.6, ~65.9
Peak Gain (dBi)	~2.5, ~2.6
Impedance (Ohm)	50
Polarisation	RHCP
Radiation Pattern	Hemispherical

2J7C01MC2F L1/L2 High Precision GNSS RTK Antenna

GPS/GLONASS/BEIDOU/QZSS/Galileo/L1/L2

- Key Features**  Ground Plane Dependent  Customizable Cable and Connector  Low Noise Figure  Low Power Consumption
 Certificates: IP67 - Water Resistant, IP69 - Hot Water Pressure  Pre-Filter GNSS



General specification

Mounting type	Magnetic mount
Dimensions (mm)	Ø 54 × 21.2
Operating temperature	-40 °C to +85 °C
Certificates	IP67, IP69

Antenna and electrical specifications

GPS/GLONASS/BEIDOU/QZSS/Galileo/L1/L2

Technologies	GPS(L1,L2)/GLONASS(L1OF)/BeiDou(B1)/QZSS(L1,L2)/Galileo(E1)	
Frequency (MHz)	1227.6,	1561.09, 1575.42, 1602
Standards	GPS(L2C), QZSS(L2C),	GPS(L1C), GLONASS(L1OF), BeiDou(B1) QZSS(L1C), Galileo(E1), SBAS (L1)
Impedance (Ohm)	50	
VSWR	~1.5:1,	~1.7:1
Efficiency (%)	~63.8,	~63.8
Active Gain (dB)	28 @ 3 V	
Voltage (V)	2.3 - 6	
Current Consumption (mA)	16 @ 3 V	
Power Consumption (mW)	48 @ 3 V	
Saw Filter Type	Pre-Filter	
Polarisation	RHCP	

2J3702M-2.4

2.4GHz/WiFi/LPWA/BT/ISM

- Key Features**  Ground Plane Dependent  Customizable Cable and Connector  Low Profile



General specification

Mounting type	Magnetic mount
Dimensions (mm)	Ø 31 × 71.5
Operating temperature	-40 °C to +85 °C

Antenna and electrical specifications

2.4GHz/WiFi/LPWA/BT/ISM

Standards	WiFi/Sigfox/LoRa/LPWA/Bluetooth/BLE/ZigBee/RFID/RPMA/ISM
Frequency (MHz)	2410-2490
VSWR	~1.2:1
Efficiency (%)	~43
Peak Gain (dBi)	~1.6
Impedance (Ohm)	50
Polarisation	Linear
Radiation Pattern	Omni-Directional
Max. Input Power (W)	25

2J7402M-2.4

2.4GHz/WiFi/LPWA/BT/ISM

- Key Features**  Ground Plane Dependent  Customizable Cable and Connector  Certificates: IP67 - Water Resistant, IP69 - Hot Water Pressure



General specification

Mounting type	Magnetic mount
Dimensions (mm)	Ø 54 × 14.7
Operating temperature	-40 °C to +85 °C
Certificates	IP67, IP69

Antenna and electrical specifications

2.4GHz/WiFi/LPWA/BT/ISM

Standards	WiFi/Sigfox/LoRa/LPWA/Bluetooth/BLE/ZigBee/RFID/RPMA/ISM
Frequency (MHz)	2410-2490
VSWR	~1.4:1
Efficiency (%)	~56.5
Peak Gain (dBi)	~3.8
Impedance (Ohm)	50
Polarisation	Linear
Radiation Pattern	Omni-Directional
Max. Input Power (W)	25

2J3415M-433

433MHz/LPWA/RFID/ZigBee/ISM

Key Features ✓ Ground Plane Dependent ✓ Customizable Cable and Connector



General specification

Mounting type	Magnetic mount
Dimensions (mm)	∅ 31 × 164
Operating temperature	-40 °C to +85 °C

Antenna and electrical specifications 433MHz/LPWA/RFID/ZigBee/ISM

Standards	Sigfox/LoRa/RFID/LPWA/ISM/UHF
Frequency (MHz)	433-435
VSWR	~1.1:1
Efficiency (%)	~61.7
Peak Gain (dBi)	~2.1
Impedance (Ohm)	50
Polarisation	Linear
Radiation Pattern	Omni-Directional
Max. Input Power (W)	50

2J6515M-433

433MHz/LPWA/RFID/ZigBee/ISM

Key Features ✓ Ground Plane Dependent ✓ Customizable Cable and Connector
 ✓ Certificates: IP67 - Water Resistant, IP69 - Hot Water Pressure, IK09 - Impact Resistant



General specification

Mounting type	Magnetic mount
Dimensions (mm)	∅ 135,5 × 30
Operating temperature	-40 °C to +85 °C
Certificates	IP67, IP69, IK09

Antenna and electrical specifications 433MHz/LPWA/RFID/ZigBee/ISM

Standards	Sigfox/LoRa/RFID/LPWA/ISM/UHF
Frequency (MHz)	433-435
VSWR	~1.1:1
Efficiency (%)	~58.1
Peak Gain (dBi)	~2.9
Impedance (Ohm)	50
Polarisation	Linear
Radiation Pattern	Omni-Directional
Max. Input Power (W)	50

2J7515M-433

433MHz/LPWA/RFID/ZigBee/ISM

Key Features ✓ Ground Plane Dependent ✓ Customizable Cable and Connector ✓ Certificates: IP67 - Water Resistant, IP69 - Hot Water Pressure



General specification

Mounting type	Magnetic mount
Dimensions (mm)	∅ 54 × 80.3
Operating temperature	-40 °C to +85 °C
Certificates	IP67, IP69

Antenna and electrical specifications 433MHz/LPWA/RFID/ZigBee/ISM

Standards	Sigfox/LoRa/RFID/LPWA/ISM/UHF
Frequency (MHz)	433-435
VSWR	~1.4:1
Efficiency (%)	~41.9
Peak Gain (dBi)	~1.1
Impedance (Ohm)	50
Polarisation	Linear
Radiation Pattern	Omni-Directional
Max. Input Power (W)	25

2J7815M-433

433MHz/LPWA/RFID/ZigBee/ISM

Key Features  Ground Plane Dependent  Customizable Cable and Connector  Certificates: IP67 - Water Resistant, IP69 - Hot Water Pressure



General specification

Mounting type	Magnetic mount
Dimensions (mm)	Ø 54 × 80.3
Operating temperature	-40 °C to +85 °C
Certificates	IP67, IP69

Antenna and electrical specifications 433MHz/LPWA/RFID/ZigBee/ISM

Standards	Sigfox/LoRa/RFID/LPWA/ISM/UHF
Frequency (MHz)	433-435
VSWR	~2.0:1
Efficiency (%)	~62
Peak Gain (dBi)	~0.1
Impedance (Ohm)	50
Polarisation	Linear
Radiation Pattern	Omni-Directional
Max. Input Power (W)	50

2J3915M-868

868MHz/Sigfox/LoRa/LPWA/RFID/ZigBee/ISM

Key Features  High Performance  Ground Plane Dependent  Customizable Cable and Connector



General specification

Mounting type	Magnetic mount
Dimensions (mm)	Ø 30.9 × 91
Operating temperature	-40 °C to +85 °C

Antenna and electrical specifications 868MHz/Sigfox/LoRa/LPWA/RFID/ZigBee/ISM

Standards	Sigfox/LoRa/ZigBee/RFID/LPWA/ISM/UHF
Frequency (MHz)	863-870
VSWR	~1.3:1
Efficiency (%)	~64.5
Peak Gain (dBi)	~2.6
Impedance (Ohm)	50
Polarisation	Linear
Radiation Pattern	Omni-Directional
Max. Input Power (W)	50

2J3915M-915

915MHz/Sigfox/LoRa/LPWA/RFID/ZigBee/ISM

Key Features  High Performance  Ground Plane Dependent  Customizable Cable and Connector



General specification

Mounting type	Magnetic mount
Dimensions (mm)	Ø 30.9 × 91
Operating temperature	-40 °C to +85 °C

Antenna and electrical specifications 915MHz/Sigfox/LoRa/LPWA/RFID/ZigBee/ISM

Standards	Sigfox/LoRa/ZigBee/RFID/LPWA/ISM/UHF
Frequency (MHz)	902-928
VSWR	~1.5:1
Efficiency (%)	~64.6
Peak Gain (dBi)	~3.0
Impedance (Ohm)	50
Polarisation	Linear
Radiation Pattern	Omni-Directional
Max. Input Power (W)	50

2J6026M iridium certified antenna

IRIDIUM

Key Features  Low Profile  Ground Plane Independent  Customizable Cable and Connector

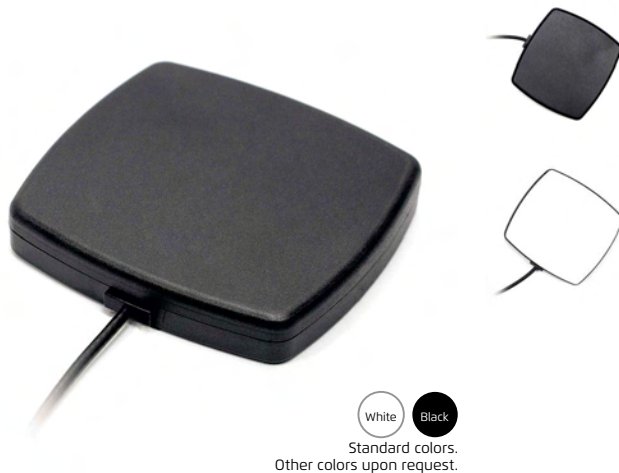

General specification

Mounting type	Magnetic mount
Dimensions (mm)	80 × 76 × 13
Operating temperature	-40 °C to +85 °C

Antenna and electrical specifications

IRIDIUM

Standards	IRIDIUM
Frequency (MHz)	1616-1627
VSWR	~1.2:1
Efficiency (%)	~76
Peak Gain (dBi)	~4.5
Impedance (Ohm)	50
Polarisation	RHCP
Radiation Pattern	Hemispherical
Axial Ratio (dB)	3 max

2J7426Mz

IRIDIUM

Key Features  Ground Plane Independent  Customizable Cable and Connector  Certificates: IP67 - Water Resistant, IP69 - Hot Water Pressure



General specification

Mounting type	Magnetic mount
Dimensions (mm)	∅ 54 × 14.7
Operating temperature	-40 °C to +85 °C
Certificates	IP67, IP69

Antenna and electrical specifications

IRIDIUM

Standards	IRIDIUM
Frequency (MHz)	1616-1627
VSWR	~1.1:1
Efficiency (%)	~82.3
Peak Gain (dBi)	~5.1
Impedance (Ohm)	50
Polarisation	RHCP
Radiation Pattern	Hemispherical

2J7213M

DAB/HDTV-DVBT

Key Features  Ground Plane Dependent  Customizable Cable and Connector  Certificates: IP67 - Water Resistant, IP69 - Hot Water Pressure



General specification

Mounting type	Magnetic mount
Dimensions (mm)	∅ 54 × 96.1
Operating temperature	-40 °C to +85 °C
Certificates	IP67, IP69

Antenna and electrical specifications

DAB/HDTV-DVBT

Standards	DAB/HDTV-DVBT
Frequency (MHz)	150-240, 440-870
VSWR	~3:1
Active Gain (dB)	23
Impedance (Ohm)	75
Polarisation	Linear
Radiation Pattern	Hemispherical
Power Consumption (mW)	390 max.
Voltage (V)	3.3-16
Current (mA)	13

2J6024MP

4GLTE/FirstNet/LPWA/NB-IoT/3G/2G

Key Features ✓ Low Profile ✓ Ground Plane Independent ✓ Customizable Cable and Connector

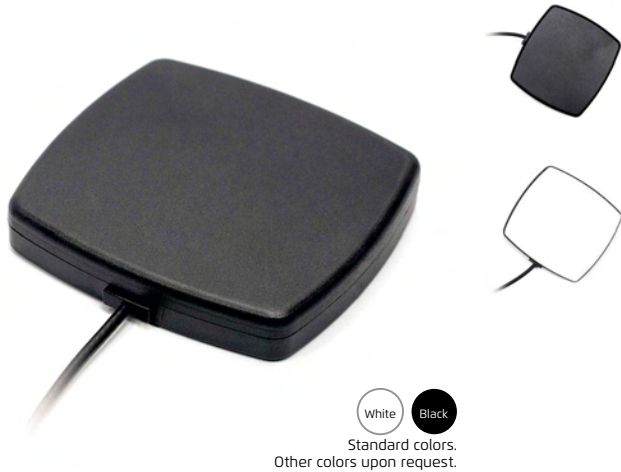

General specification

Mounting type	Magnetic/Adhesive mount
Dimensions (mm)	80 × 76 × 13
Operating temperature	-40 °C to +85 °C

Antenna and electrical specifications

4GLTE/FirstNet/LPWA/NB-IoT/3G/2G

Standards	4GLTE/FirstNet/LPWA/ CAT-X/CAT-Mx/CAT-NBx/NB-IoT/3G/2G
Frequency (MHz)	698-960, 1710-2170, 2500-2700
VSWR	~2.2:1, ~2.6:1, ~2.1:1
Efficiency (%)	~25.3, ~20.2, ~36.1
Peak Gain (dBi)	~-0.7, ~1.7, ~4.4
Impedance (Ohm)	50
Polarisation	Linear
Radiation Pattern	Omni-Directional
Max. Input Power (W)	25

2J6804MP

3G/2G/CELLULAR

Key Features ✓ Ground Plane Dependent ✓ Customizable Cable and Connector



General specification

Mounting type	Magnetic/Adhesive mount
Dimensions (mm)	117 × 49.5 × 38
Operating temperature	-40 °C to +85 °C

Antenna and electrical specifications

3G/2G/CELLULAR

Standards	3G/Cellular/HSPA/UMTS/WCDA/ EDGE/EGPRS/GRPS/GSM/CDMA/2G
Frequency (MHz)	824-960, 1710-2170
VSWR	~1.4:1, ~1.5:1
Efficiency (%)	~39, ~36
Peak Gain (dBi)	~-0.9, ~-0.7
Impedance (Ohm)	50
Polarisation	Linear
Radiation Pattern	Omni-Directional
Max. Input Power (W)	50

2J4301MPFx Active GNSS

GPS/QZSS/Galileo/L1

Key Features ✓ Post-Filter GNSS ✓ Ground Plane Independent ✓ Customizable Cable and Connector ✓ Certificates: IP67 - Water Resistant



General specification

Mounting type	Magnetic/Adhesive mount
Dimensions (mm)	38 × 34 × 13.5/14.5
Operating temperature	-40 °C to +85 °C
Certificates	IP67

Antenna and electrical specifications

GPS/QZSS/Galileo/L1

Standards	GPS(L1)/QZSS(L1)/Galileo(E1)
Frequency (MHz)	1575.42
VSWR	<1.2:1
Impedance (Ohm)	50
Radiation Pattern	Hemispherical
Polarisation	RHCP
Active Gain (dB)	23 @ 3V, 24 @ 5V
Voltage (V)	2.7 - 5.5
Current Consumption (mA)	15 - 25
Power Consumption (mW)	138 Max
Saw Filter Type	Post-Filter

2J4C01MP Active GNSS GPS/QZSS/Galileo/L1

Key Features ✓ Pre-Filter GNSS ✓ Ground Plane Independent ✓ Customizable Cable and Connector ✓ Certificates: IP67 - Water Resistant



Standard colors.
Other colors upon request.



General specification

Mounting type	Magnetic/Adhesive mount
Dimensions (mm)	28 × 21.3 × 13/14
Operating temperature	-40 °C to +85 °C
Certificates	IP67

Antenna and electrical specifications GPS/QZSS/Galileo/L1

Standards	GPS(L1)/QZSS(L1)/Galileo(E1)
Frequency (MHz)	1575.42
VSWR	<1.2:1
Impedance (Ohm)	50
Radiation Pattern	Hemispherical
Polarisation	RHCP
Active Gain (dB)	23 @ 3V, 25 @ 5V
Voltage (V)	2.7 - 5.5
Current Consumption (mA)	15 - 25
Power Consumption (mW)	138 Max
Saw Filter Type	Pre-Filter

2J4301MPGF Active GNSS GPS/GLONASS/QZSS/Galileo/L1

Key Features ✓ Pre-Filter GNSS ✓ Ground Plane Independent ✓ Customizable Cable and Connector ✓ Certificates: IP67 - Water Resistant



Standard colors.
Other colors upon request.



General specification

Mounting type	Magnetic/Adhesive mount
Dimensions (mm)	38 × 34 × 13.5/14.5
Operating temperature	-40 °C to +85 °C
Certificates	IP67

Antenna and electrical specifications GPS/GLONASS/QZSS/Galileo/L1

Standards	GPS(L1)/GLONASS(L10F)/QZSS(L1)/Galileo(E1)
Frequency (MHz)	1575.42, 1598-1606
VSWR	<1.4:1
Impedance (Ohm)	50
Radiation Pattern	Hemispherical
Polarisation	RHCP
Active Gain (dB)	28 @ 2.7 V
Voltage (V)	1.5 - 3.6
Current Consumption (mA)	9 @ 2.7 V
Power Consumption (mW)	24.3 Typ
Saw Filter Type	Pre-Filter
ESD Protection (kV)	2

2J4501MPGF Active GNSS GPS/GLONASS/QZSS/Galileo/L1

Key Features ✓ Pre-Filter GNSS ✓ Ground Plane Independent ✓ Customizable Cable and Connector ✓ Certificates: IP67 - Water Resistant



Standard colors.
Other colors upon request.

General specification

Mounting type	Magnetic/Adhesive mount
Dimensions (mm)	40 × 40 × 13.7
Operating temperature	-40 °C to +85 °C
Certificates	IP67

Antenna and electrical specifications GPS/GLONASS/QZSS/Galileo/L1

Standards	GPS(L1)/GLONASS(L10F)/QZSS(L1)/Galileo(E1)
Frequency (MHz)	1575.42, 1598-1606
VSWR	<1.5:1
Impedance (Ohm)	50
Radiation Pattern	Hemispherical
Polarisation	RHCP
Active Gain (dB)	32 @ 5 V
Voltage (V)	1.8 - 5
Current Consumption (mA)	5 - 25
Power Consumption (mW)	9 - 125
Saw Filter Type	Pre-Filter

2J4D01MPGF Active GNSS

GPS/GLONASS/QZSS/Galileo/L1

Key Features ✔ Pre-Filter GNSS ✔ Ground Plane Independent ✔ Customizable Cable and Connector ✔ Certificates: IP67 - Water Resistant



White Black
Standard colors.
Other colors upon request.

General specification

Mounting type	Magnetic/Adhesive mount
Dimensions (mm)	41 × 34 × 13.5/14.5
Operating temperature	-40 °C to +85 °C
Certificates	IP67

Antenna and electrical specifications

GPS/GLONASS/QZSS/Galileo/L1

Standards	GPS(L1)/GLONASS(L10F)/QZSS(L1)/Galileo(E1)
Frequency (MHz)	1575.42, 1598-1606
VSWR	<1.4:1
Impedance (Ohm)	50
Radiation Pattern	Hemispherical
Polarisation	RHCP
Active Gain (dB)	28 @ 2.7 V
Voltage (V)	1.5 – 3.6
Current Consumption (mA)	9 Typ
Power Consumption (mW)	24.3 Typ
Saw Filter Type	Pre-Filter
ESD Protection (kV)	2

2J4D01MPCF Active GNSS

GPS/GLONASS/BEIDOU/QZSS/Galileo/L1

Key Features ✔ Pre-Filter GNSS ✔ Ground Plane Independent ✔ Customizable Cable and Connector ✔ Certificates: IP67 - Water Resistant



White Black
Standard colors.
Other colors upon request.

General specification

Mounting type	Magnetic/Adhesive mount
Dimensions (mm)	41 × 34 × 13.5/14.5
Operating temperature	-40 °C to +85 °C
Certificates	IP67

Antenna and electrical specifications

GPS/GLONASS/BEIDOU/QZSS/Galileo/L1

Standards	GPS(L1)/GLONASS(L10F)/BeiDou(B1)/QZSS(L1)/Galileo(E1)
Frequency (MHz)	1561.098, 1575.42, 1598-1606
VSWR	<1.4:1
Impedance (Ohm)	50
Radiation Pattern	Hemispherical
Polarisation	RHCP
Active Gain (dB)	28 @ 2.7 V
Voltage (V)	1.5 – 3.6
Current Consumption (mA)	9 Typ
Power Consumption (mW)	24.3 Typ
Saw Filter Type	Pre-Filter

2J6302MP

2.4-5.0GHz/WiFi/LPWA/BT/ISM

Key Features ✔ Ground Plane Dependent ✔ Customizable Cable and Connector ✔ Certificates: IP67 - Water Resistant



White Black
Standard colors.
Other colors upon request.

General specification

Mounting type	Magnetic/Adhesive mount
Dimensions (mm)	∅ 52.5 × 14.3
Operating temperature	-40 °C to +85 °C
Certificates	IP67

Antenna and electrical specifications

2.4-5.0GHz/WiFi/LPWA/BT/ISM

Standards	WiFi/Sigfox/LoRa/LPWA/Bluetooth/ BLE/ZigBee/RFID/RFMA/ISM
Frequency (MHz)	2410-2490, 4920-5925
VSWR	~1.6:1, ~1.5:1
Efficiency (%)	~42.7, ~29.7
Peak Gain (dBi)	~1.7, ~2.3
Impedance (Ohm)	50
Polarisation	Linear
Radiation Pattern	Omni-Directional
Max. Input Power (W)	25

2J4824VP 4GLTE/FirstNet/LPWA/NB-IoT/3G/2G

Key Features Ground Plane Independent Customizable Cable and Connector Certificates: IP67 - Water Resistant, IP69 - Hot Water Pressure Optional Antenna Detection Resistor



Standard colors.
Other colors upon request.



General specification

Mounting type	Velcro/Adhesive mount
Dimensions (mm)	83 × 35 × 13.3
Operating temperature	-40 °C to +85 °C
Certificates	IP67, IP69

Antenna and electrical specifications 4GLTE/FirstNet/LPWA/NB-IoT/3G/2G

Standards	4GLTE/FirstNet/LPWA/ CAT-X/CAT-Mx/CAT-NBx/NB-IoT/3G/2G
Frequency (MHz)	698-960, 1710-2170, 2500-2700
VSWR	~1.9:1, ~1.4:1, ~1.8:1
Efficiency (%)	~59, ~55, ~31
Peak Gain (dBi)	~3.4, ~2.1, ~1.0
Impedance (Ohm)	50
Polarisation	Linear
Radiation Pattern	Omni-Directional
Max. Input Power (W)	25

2J5024VP 4GLTE/FirstNet/LPWA/NB-IoT/3G/2G

Key Features Ground Plane Independent Customizable Cable and Connector Optional Antenna Detection Resistor



Standard colors.
Other colors upon request.

General specification

Mounting type	Velcro/Adhesive mount
Dimensions (mm)	116 × 22 × 6.7
Operating temperature	-40 °C to +85 °C

Antenna and electrical specifications 4GLTE/FirstNet/LPWA/NB-IoT/3G/2G

Standards	4GLTE/FirstNet/LPWA/ CAT-X/CAT-Mx/CAT-NBx/NB-IoT/3G/2G
Frequency (MHz)	698-960, 1710-2170, 2500-2700
VSWR	~1.3:1, ~1.4:1, ~1.4:1
Efficiency (%)	~65, ~41, ~34
Peak Gain (dBi)	~3.0, ~2.2, ~4.0
Impedance (Ohm)	50
Polarisation	Linear
Radiation Pattern	Omni-Directional
Max. Input Power (W)	25

2J5502VP 2.4-5.0GHz/WiFi/LPWA/BT/ISM

Key Features Ground Plane Independent Customizable Cable and Connector



Standard colors.
Other colors upon request.

General specification

Mounting type	Velcro/Adhesive mount
Dimensions (mm)	71 × 25 × 7
Operating temperature	-40 °C to +85 °C

Antenna and electrical specifications 2.4-5.0GHz/WiFi/LPWA/BT/ISM

Standards	WiFi/Sigfox/LoRa/LPWA/Bluetooth/ BLE/ZigBee/RFID/RFMA/ISM
Frequency (MHz)	2410-2490, 4920-5925
VSWR	~1.3:1, ~1.9:1
Efficiency (%)	~56.7, ~34.2
Peak Gain (dBi)	~3.4, ~2.6
Impedance (Ohm)	50
Polarisation	Linear
Radiation Pattern	Omni-Directional
Max. Input Power (W)	25

2J2024B-B05H 4GLTE/FirstNet/LPWA/NB-IoT/3G/2G

Key Features High Performance Ground Plane Independent Customizable Cable and Connector Certificates: IP67 - Water Resistant



General specification

Mounting type	Wall mount
Dimensions (mm)	369 × 36 × 155 (264 × Ø 16)
Operating temperature	-40 °C to +85 °C
Certificates	IP67

Antenna and electrical specifications 4GLTE/FirstNet/LPWA/NB-IoT/3G/2G

Standards	4GLTE/FirstNet/LPWA/ CAT-X/CAT-Mx/CAT-NBx/NB-IoT/3G/2G
Frequency (MHz)	698-960, 1710-2170, 2500-2700
VSWR	~1.5:1, ~1.4:1, ~1.5:1
Efficiency (%)	~57, ~53.7, ~49.9
Peak Gain (dBi)	~2.4, ~2.7, ~0.4
Impedance (Ohm)	50
Polarisation	Linear
Radiation Pattern	Omni-Directional
Max. Input Power (W)	25

2J2124B-B05H 4GLTE/FirstNet/LPWA/NB-IoT/3G/2G

Key Features High Performance Ground Plane Independent Customizable Cable and Connector Certificates: IP67 - Water Resistant



General specification

Mounting type	Wall mount
Dimensions (mm)	325 × 36 × 155 (220 × Ø 16)
Operating temperature	-40 °C to +85 °C
Certificates	IP67

Antenna and electrical specifications 4GLTE/FirstNet/LPWA/NB-IoT/3G/2G

Standards	4GLTE/FirstNet/LPWA/ CAT-X/CAT-Mx/CAT-NBx/NB-IoT/3G/2G
Frequency (MHz)	698-960, 1710-2170, 2500-2700
VSWR	~1.4:1, ~1.4:1, ~1.4:1
Efficiency (%)	~67, ~54, ~50
Peak Gain (dBi)	~3.4, ~2.5, ~1.0
Impedance (Ohm)	50
Polarisation	Linear
Radiation Pattern	Omni-Directional
Max. Input Power (W)	25

2J2124K-B07H 4GLTE/FirstNet/LPWA/NB-IoT/3G/2G

Key Features High Performance Ground Plane Independent Customizable Cable and Connector



General specification

Mounting type	Wall mount
Dimensions (mm)	271 × 30 × 115 (220 × Ø 16)
Operating temperature	-40 °C to +85 °C

Antenna and electrical specifications 4GLTE/FirstNet/LPWA/NB-IoT/3G/2G

Standards	4GLTE/FirstNet/LPWA/ CAT-X/CAT-Mx/CAT-NBx/NB-IoT/3G/2G
Frequency (MHz)	698-960, 1710-2170, 2500-2700
VSWR	~2.8:1, ~2.5:1, ~2.7:1
Efficiency (%)	~58, ~52, ~41.9
Peak Gain (dBi)	~3.0, ~2.3, ~0.7
Impedance (Ohm)	50
Polarisation	Linear
Radiation Pattern	Omni-Directional
Max. Input Power (W)	25

2J2124B-C681N-B06H 4GLTE/FirstNet/LPWA/NB-IoT/3G/2G

Key Features High Performance Ground Plane Independent Customizable Cable and Connector



General specification

Mounting type	Wall mount
Dimensions (mm)	325 x 36 x 155 (220 x Ø 16)
Operating temperature	-40 °C to +85 °C

Antenna and electrical specifications 4GLTE/FirstNet/LPWA/NB-IoT/3G/2G

Standards	4GLTE/FirstNet/LPWA/ CAT-X/CAT-Mx/CAT-NBx/NB-IoT/3G/2G
Frequency (MHz)	698-960, 1710-2170, 2500-2700
VSWR	~1.5:1, ~1.4:1, ~1.5:1
Efficiency (%)	~57, ~53.7, ~49.9
Peak Gain (dBi)	~2.4, ~2.7, ~0.4
Impedance (Ohm)	50
Polarisation	Linear
Radiation Pattern	Omni-Directional
Max. Input Power (W)	25

2J2102K-B07H 2.4-5.0GHz/WiFi/LPWA/BT/ISM

Key Features High Performance Ground Plane Independent Customizable Cable and Connector



General specification

Mounting type	Wall mount
Dimensions (mm)	271 x 30 x 115 (220 x Ø 16)
Operating temperature	-40 °C to +85 °C

Antenna and electrical specifications 2.4-5.0GHz/WiFi/LPWA/BT/ISM

Standards	WiFi/Sigfox/LoRa/LPWA/Bluetooth/ BLE/ZigBee/RFID/RFMA/ISM
Frequency (MHz)	2410-2490, 4920-5925
VSWR	~1.5:1, ~1.2:1
Efficiency (%)	~46.3, ~25.6
Peak Gain (dBi)	~1.5, ~1.7
Impedance (Ohm)	50
Polarisation	Linear
Radiation Pattern	Omni-Directional
Max. Input Power (W)	25

2J2115B-433-B05H 433MHz/LPWA/RFID/ZigBee/ISM

Key Features Ground Plane Independent Customizable Cable and Connector Certificates: IP67 - Water Resistant



General specification

Mounting type	Wall mount
Dimensions (mm)	325 x 36 x 155 (220 x Ø 16)
Operating temperature	-40 °C to +85 °C
Certificates	IP67

Antenna and electrical specifications 433MHz/LPWA/RFID/ZigBee/ISM

Standards	Sigfox/LoRa/RFID/LPWA/ISM/UHF
Frequency (MHz)	433-435
VSWR	~2.0:1
Efficiency (%)	~53
Peak Gain (dBi)	~2.4
Impedance (Ohm)	50
Polarisation	Linear
Radiation Pattern	Omni-Directional
Max. Input Power (W)	50

2J2115B-868-B07H

868MHz/Sigfox/LoRa/LPWA/RFID/ZigBee/ISM

Key Features  High Performance  Ground Plane Independent  Customizable Cable and Connector  Certificates: IP67 - Water Resistant



General specification

Mounting type	Wall mount
Dimensions (mm)	271 × 30 × 115 (220 × Ø 16)
Operating temperature	-40 °C to +85 °C
Certificates	IP67

Antenna and electrical specifications

868MHz/Sigfox/LoRa/LPWA/RFID/ZigBee/ISM

Standards	Sigfox/LoRa/ZigBee/RFID/LPWA/ISM/UHF
Frequency (MHz)	863-870
VSWR	~1.3:1
Efficiency (%)	~61.6
Peak Gain (dBi)	~2.4
Impedance (Ohm)	50
Polarisation	Linear
Radiation Pattern	Omni-Directional
Max. Input Power (W)	25

2J2115K-868-B07H

868MHz/Sigfox/LoRa/LPWA/RFID/ZigBee/ISM

Key Features  High Performance  Ground Plane Independent  Customizable Cable and Connector



General specification

Mounting type	Wall mount
Dimensions (mm)	271 × 30 × 115 (220 × Ø 16)
Operating temperature	-40 °C to +85 °C

Antenna and electrical specifications

868MHz/Sigfox/LoRa/LPWA/RFID/ZigBee/ISM

Standards	Sigfox/LoRa/ZigBee/RFID/LPWA/ISM/UHF
Frequency (MHz)	863-870
VSWR	~1.5:1
Efficiency (%)	~65.2
Peak Gain (dBi)	~3.2
Impedance (Ohm)	50
Polarisation	Linear
Radiation Pattern	Omni-Directional
Max. Input Power (W)	25

2J2115B-915-B07H

915MHz/Sigfox/LoRa/LPWA/RFID/ZigBee/ISM

Key Features  High Performance  Ground Plane Independent  Customizable Cable and Connector  Certificates: IP67 - Water Resistant



General specification

Mounting type	Wall mount
Dimensions (mm)	271 × 30 × 115 (220 × Ø 16)
Operating temperature	-40 °C to +85 °C
Certificates	IP67

Antenna and electrical specifications

915MHz/Sigfox/LoRa/LPWA/RFID/ZigBee/ISM

Standards	Sigfox/LoRa/ZigBee/RFID/LPWA/ISM/UHF
Frequency (MHz)	902-928
VSWR	~1.9:1
Efficiency (%)	~70.7
Peak Gain (dBi)	~3.1
Impedance (Ohm)	50
Polarisation	Linear
Radiation Pattern	Omni-Directional
Max. Input Power (W)	25

2J5415HP-433

433MHz/LPWA/RFID/ZigBee/ISM

Key Features  High Gain  Ground Plane Independent  Customizable Cable and Connector



 
Standard colors.
Other colors upon request.



General specification

Mounting type	Wall/Adhesive mount
Dimensions (mm)	60 × 112.5 × 11.3
Operating temperature	-40 °C to +85 °C

Antenna and electrical specifications

433MHz/LPWA/RFID/ZigBee/ISM

Standards	Sigfox/LoRa/RFID/LPWA/ISM/UHF
Frequency (MHz)	433-435
VSWR	~1.2:1
Efficiency (%)	~46.5
Peak Gain (dBi)	~-2.4
Impedance (Ohm)	50
Polarisation	Linear
Radiation Pattern	Omni-Directional
Max. Input Power (W)	50

2J5410HP

380-470MHz/LPWA/TETRA/UHF

Key Features  High Gain  Ground Plane Independent  Customizable Cable and Connector



 
Standard colors.
Other colors upon request.



General specification

Mounting type	Wall/Adhesive mount
Dimensions (mm)	60 × 112.5 × 11.3
Operating temperature	-40 °C to +85 °C





Antenna and electrical specifications

380-470MHz/LPWA/TETRA/UHF

Standards	TETRA/UHF/PMR/LMR
Frequency (MHz)	380-470
VSWR	~2.1:1
Efficiency (%)	~45
Peak Gain (dBi)	~-2.8
Impedance (Ohm)	50
Polarisation	Linear
Radiation Pattern	Omni-Directional
Max. Input Power (W)	50

2JWIFI12 Directional Antenna

2.4-5.0GHz/WiFi/LPWA/BT/ISM

Key Features  High Performance  Ground Plane Independent  Customizable Cable and Connector  Directional Antenna
 High Gain 7.6 dBi (2.4 GHz), 7 dBi (5.0GHz)



 
Standard colors.
Other colors upon request.

General specification

Mounting type	Pole mount
Dimensions (mm)	104 × 104 × 90
Operating temperature	-40 °C to +85 °C

Antenna and electrical specifications

2.4-5.0GHz/WiFi/LPWA/BT/ISM

Standards	WiFi/Sigfox/LoRa/LPWA/Bluetooth/ BLE/ZigBee/RFID/RFMA/ISM
Frequency (MHz)	2410-2490, 4920-5925
VSWR	~1.6:1, ~1.8:1
Efficiency (%)	~60, ~63
Peak Gain (dBi)	~7.2, ~5.2
Impedance (Ohm)	50
Polarisation	Linear
Radiation Pattern	Directional
Max. Input Power (W)	25

2J9101JBWGF-B12JW-B10BW Active GNSS

GPS/GLONASS/QZSS/Galileo/L1

Key Features  Ground Plane Independent  Customizable Cable and Connector  Certificates: IP67 - Water Resistant



General specification

Mounting type	Pole/Screw mount
Dimensions (mm)	130 × 74 × 110
Operating temperature	-40 °C to +85 °C
Certificates	IP67

Antenna and electrical specifications



GPS/GLONASS/QZSS/Galileo/L1

Standards	GPS(L1)/GLONASS(L1O1F)/QZSS(L1)/Galileo(E1)
Frequency (MHz)	1575.42, 1598-1606
VSWR	<1.4:1
Impedance (Ohm)	50
Radiation Pattern	Hemispherical
Polarisation	RHCP
Active Gain (dB)	23 @ 3V, 24 @ 5V
Voltage (V)	2.7 - 5.5
Current Consumption (mA)	15 - 25
Power Consumption (mW)	138 Max
Saw Filter Type	Pre-Filter

2J9026JBW-C392N-B10BW iridium certified antenna

IRIDIUM

Key Features  Ground Plane Independent  Customizable Cable and Connector  Certificates: IP67 - Water Resistant

 High Performance  TNC Female Bulkhead Connector inside Antenna Housing



General specification

Mounting type	Pole/Screw mount
Dimensions (mm)	116 × 74 × 110
Operating temperature	-40 °C to +85 °C
Certificates	IP67

Antenna and electrical specifications

IRIDIUM

Standards	IRIDIUM
Frequency (MHz)	1616-1627
VSWR	~1.2:1
Efficiency (%)	~76
Peak Gain (dBi)	~4.5
Impedance (Ohm)	50
Polarisation	RHCP
Radiation Pattern	Hemispherical
Axial Ratio (dB)	3 max

2J9126JBW-B12JW-B10BW iridium certified antenna

IRIDIUM

Key Features  High Performance  Ground Plane Independent  Customizable Cable and Connector  Certificates: IP67 - Water Resistant



General specification

Mounting type	Pole/Screw mount
Dimensions (mm)	130 × 74 × 110
Operating temperature	-40 °C to +85 °C
Certificates	IP67

Antenna and electrical specifications

IRIDIUM

Standards	IRIDIUM
Frequency (MHz)	1616-1627
VSWR	~1.2:1
Efficiency (%)	~76
Peak Gain (dBi)	~4.5
Impedance (Ohm)	50
Polarisation	RHCP
Radiation Pattern	Hemispherical
Axial Ratio (dB)	3 max

Combination External Antennas





2J6024Ba

2x 4GLTE/FirstNet/LPWA/NB-IoT/3G/2G

- Key Features**
- ✔ Low Profile
 - ✔ Ground Plane Independent
 - ✔ Customizable Cable and Connector
 - ✔ Certificates: IP67 - Water Resistant

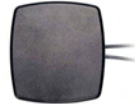

Standard colors.
Other colors upon request.

General specification

Mounting type	Screw mount
Dimensions (mm)	80 × 74 × 14.7
Operating temperature	-40 °C to +85 °C
Thread Length options	8.5mm, 19mm (Default), 30mm
Certificates	IP67

Antenna and electrical specifications

4GLTE/FirstNet/LPWA/NB-IoT/3G/2G (Connection 1)

Standards	4GLTE/FirstNet/LPWA/ CAT-X/CAT-Mx/CAT-NBx/NB-IoT/3G/2G
Frequency (MHz)	698-960, 1710-2170, 2500-2700
VSWR	~2.1:1, ~2.4:1, ~1.3:1
Efficiency (%)	~31.5, ~30.4, ~43.8
Peak Gain (dBi)	~0.7, ~2.7, ~4.3
Impedance (Ohm)	50
Polarisation	Linear
Radiation Pattern	Omni-Directional
Max. Input Power (W)	25

Antenna and electrical specifications

4GLTE/FirstNet/LPWA/NB-IoT/3G/2G (Connection 2)

Standards	4GLTE/FirstNet/LPWA/ CAT-X/CAT-Mx/CAT-NBx/NB-IoT/3G/2G
Frequency (MHz)	698-960, 1710-2170, 2500-2700
VSWR	~2.0:1, ~2.3:1, ~1.3:1
Efficiency (%)	~33.0, ~29.5, ~43.1
Peak Gain (dBi)	~1.4, ~2.2, ~4.4
Impedance (Ohm)	50
Polarisation	Linear
Radiation Pattern	Omni-Directional
Max. Input Power (W)	25

2J6524Ba for EU LTE only

2x 4GLTE/FirstNet/LPWA/NB-IoT/3G/2G

- Key Features**
- ✔ Ground Plane Dependent
 - ✔ Customizable Cable and Connector
 - ✔ Certificates: IP67 - Water Resistant, IP69 - Hot Water Pressure, IK09 - Impact Resistant



Standard colors.
Other colors upon request.

General specification

Mounting type	Screw mount
Dimensions (mm)	Ø 146 × 31.5
Operating temperature	-40 °C to +85 °C
Certificates	IP67, IP69, IK09

Antenna and electrical specifications

4GLTE/FirstNet/LPWA/NB-IoT/3G/2G (Connection 1)

Standards	4GLTE/FirstNet/LPWA/ CAT-X/CAT-Mx/CAT-NBx/NB-IoT/3G/2G
Frequency (MHz)	791-960, 1710-2170, 2500-2700
VSWR	~2.2:1, ~1.5:1, ~1.6:1
Efficiency (%)	~27.0, ~34.2, ~24.2
Peak Gain (dBi)	~-1.1, ~2.2, ~0.8
Impedance (Ohm)	50
Polarisation	Linear
Radiation Pattern	Omni-Directional
Max. Input Power (W)	25

Antenna and electrical specifications

4GLTE/FirstNet/LPWA/NB-IoT/3G/2G (Connection 2)

Standards	4GLTE/FirstNet/LPWA/ CAT-X/CAT-Mx/CAT-NBx/NB-IoT/3G/2G
Frequency (MHz)	791-960, 1710-2170, 2500-2700
VSWR	~2.5:1, ~1.7:1, ~1.6:1
Efficiency (%)	~22.9, ~26.5, ~24.1
Peak Gain (dBi)	~-1.9, ~0.2, ~0.5
Impedance (Ohm)	50
Polarisation	Linear
Radiation Pattern	Omni-Directional
Max. Input Power (W)	25



2J6A24Ba

2x 4GLTE/FirstNet/LPWA/NB-IoT/3G/2G

- Key Features**
- ✔ Ground Plane Dependent
 - ✔ Customizable Cable and Connector
 - ✔ Certificates: IP67 - Water Resistant, IP69 - Hot Water Pressure, IK09 - Impact Resistant
 - ✔ Anti-rotation Mounting



White Black
Standard colors.
Other colors upon request.

General specification

Mounting type	Screw mount
Dimensions (mm)	Ø 77.3 × 65.5
Operating temperature	-40 °C to +85 °C
Certificates	IP67, IP69, IK09

Antenna and electrical specifications

4GLTE/FirstNet/LPWA/NB-IoT/3G/2G (Connection 1)

Standards	4GLTE/FirstNet/LPWA/ CAT-X/CAT-Mx/CAT-NBx/NB-IoT/3G/2G
Frequency (MHz)	698-960, 1710-2170, 2500-2700
VSWR	~2.8:1, ~1.7:1, ~1.3:1
Efficiency (%)	~35, ~51, ~49
Peak Gain (dBi)	~-0.8, ~2.5, ~3.4
Impedance (Ohm)	50
Polarisation	Linear
Radiation Pattern	Omni-Directional
Max. Input Power (W)	25

Antenna and electrical specifications

4GLTE/FirstNet/LPWA/NB-IoT/3G/2G (Connection 2)

Standards	4GLTE/FirstNet/LPWA/ CAT-X/CAT-Mx/CAT-NBx/NB-IoT/3G/2G
Frequency (MHz)	698-960, 1710-2170, 2500-2700
VSWR	~2.9:1, ~1.4:1, ~1.8:1
Efficiency (%)	~34.2, ~41.1, ~36.7
Peak Gain (dBi)	~-1.0, ~-1.7, ~-3.2
Impedance (Ohm)	50
Polarisation	Linear
Radiation Pattern	Omni-Directional
Max. Input Power (W)	25

2J7024Ba

2x 4GLTE/FirstNet/LPWA/NB-IoT/3G/2G

- Key Features**
- ✔ High Performance
 - ✔ Customizable Cable and Connector
 - ✔ Ground Plane Independent
 - ✔ Heavy Duty antenna with Anti-Rotation Mounting
 - ✔ Certificates: IP67 - Water Resistant, IP69 - Hot Water Pressure, IK09 - Impact Resistant
 - ✔ Certified for Railway industry



White Black
Standard colors.
Other colors upon request.

General specification

Mounting type	Screw mount
Dimensions (mm)	Ø 96 × 90
Operating temperature	-40 °C to +85 °C
Certificates	IP67, IP69, IK09, Certified for Railway industry

Antenna and electrical specifications

4GLTE/FirstNet/LPWA/NB-IoT/3G/2G (Connection 1)

Standards	4GLTE/FirstNet/LPWA/ CAT-X/CAT-Mx/CAT-NBx/NB-IoT/3G/2G
Frequency (MHz)	698-960, 1710-2170, 2500-2700
VSWR	~1.9:1, ~1.6:1, ~1.7:1
Efficiency (%)	~57, ~57, ~47
Peak Gain (dBi)	~2.1, ~4.2, ~3.1
Impedance (Ohm)	50
Polarisation	Linear
Radiation Pattern	Omni-Directional
Max. Input Power (W)	25

Antenna and electrical specifications

4GLTE/FirstNet/LPWA/NB-IoT/3G/2G (Connection 2)

Standards	4GLTE/FirstNet/LPWA/ CAT-X/CAT-Mx/CAT-NBx/NB-IoT/3G/2G
Frequency (MHz)	698-960, 1710-2170, 2500-2700
VSWR	~1.9:1, ~1.6:1, ~1.4:1
Efficiency (%)	~63, ~54, ~57
Peak Gain (dBi)	~3.0, ~3.2, ~4.0
Impedance (Ohm)	50
Polarisation	Linear
Radiation Pattern	Omni-Directional
Max. Input Power (W)	25



2J7724Ba

2x 4GLTE/FirstNet/LPWA/NB-IoT/3G/2G

- Key Features**
- ✔ High Performance
 - ✔ Ground Plane Dependent
 - ✔ Customizable Cable and Connector
 - ✔ Anti-Rotation Mounting
 - ✔ Certificates: IP67 - Water Resistant, IP69 - Hot Water Pressure, IK09 - Impact Resistant



General specification

Mounting type	Screw mount
Dimensions (mm)	Ø 60 × 69
Operating temperature	-40 °C to +85 °C
Certificates	IP67, IP69, IK09

Antenna and electrical specifications

4GLTE/FirstNet/LPWA/NB-IoT/3G/2G (Connection 1)

Standards	4GLTE/FirstNet/LPWA/ CAT-X/CAT-Mx/CAT-NBx/NB-IoT/3G/2G
Frequency (MHz)	698-960, 1710-2170, 2500-2700
VSWR	~2.9:1, ~1.4:1, ~1.4:1
Efficiency (%)	~37.8, ~53.3, ~54.9
Peak Gain (dBi)	~-0.8, ~3.6, ~4.1
Impedance (Ohm)	50
Polarisation	Linear
Radiation Pattern	Omni-Directional
Max. Input Power (W)	25

Antenna and electrical specifications

4GLTE/FirstNet/LPWA/NB-IoT/3G/2G (Connection 2)

Standards	4GLTE/FirstNet/LPWA/ CAT-X/CAT-Mx/CAT-NBx/NB-IoT/3G/2G
Frequency (MHz)	698-960, 1710-2170, 2500-2700
VSWR	~2.8:1, ~1.5:1, ~2.1:1
Efficiency (%)	~38.7, ~52.3, ~42.1
Peak Gain (dBi)	~-0.6, ~2.9, ~3.0
Impedance (Ohm)	50
Polarisation	Linear
Radiation Pattern	Omni-Directional
Max. Input Power (W)	25

2J9524a-B01

2x 4GLTE/FirstNet/LPWA/NB-IoT/3G/2G

- Key Features**
- ✔ High Performance
 - ✔ Ground Plane Independent
 - ✔ Customizable Cable and Connector
 - ✔ Certificates: IP69 - Hot Water Pressure



General specification

Mounting type	Screw mount
Dimensions (mm)	280 × 280 × 150
Operating temperature	-40 °C to +85 °C
Certificates	IP69

Antenna and electrical specifications

4GLTE/FirstNet/LPWA/NB-IoT/3G/2G (Connection 1)

Standards	4GLTE/FirstNet/LPWA/ CAT-X/CAT-Mx/CAT-NBx/NB-IoT/3G/2G
Frequency (MHz)	698-960, 1710-2170, 2500-2700
VSWR	~1.7:1, ~1.3:1, ~1.3:1
Efficiency (%)	~72, ~71, ~72
Peak Gain (dBi)	~3.5, ~4.6, ~3.9
Impedance (Ohm)	50
Polarisation	Linear
Radiation Pattern	Omni-Directional
Max. Input Power (W)	25

Antenna and electrical specifications

4GLTE/FirstNet/LPWA/NB-IoT/3G/2G (Connection 2)

Standards	4GLTE/FirstNet/LPWA/ CAT-X/CAT-Mx/CAT-NBx/NB-IoT/3G/2G
Frequency (MHz)	698-960, 1710-2170, 2500-2700
VSWR	~1.7:1, ~1.3:1, ~1.2:1
Efficiency (%)	~74, ~72, ~70
Peak Gain (dBi)	~3.8, ~5.8, ~4.0
Impedance (Ohm)	50
Polarisation	Linear
Radiation Pattern	Omni-Directional
Max. Input Power (W)	25



2J6A41BF Active GNSS 4GLTE/FirstNet/LPWA/NB-IoT/3G/2G & GPS/QZSS/Galileo/L1

- Key Features**
- ✔ Ground Plane Dependent
 - ✔ Pre-Filter GNSS
 - ✔ Certificates: IP67 - Water Resistant, IP69 - Hot Water Pressure, IK09 - Impact Resistant
 - ✔ Customizable Cable and Connector
 - ✔ Anti-rotation Mounting



Standard colors.
Other colors upon request.



General specification

Mounting type	Screw mount
Dimensions (mm)	Ø 77.3 × 65.5
Operating temperature	-40 °C to +85 °C
Certificates	IP67, IP69, IK09

Antenna and electrical specifications

4GLTE/FirstNet/LPWA/NB-IoT/3G/2G (Connection 1)

Standards	4GLTE/FirstNet/LPWA/ CAT-X/CAT-Mx/CAT-NBx/NB-IoT/3G/2G
Frequency (MHz)	698-960, 1710-2170, 2500-2700
VSWR	~2.2:1, ~1.5:1, ~2.4:1
Efficiency (%)	~56, ~51, ~39
Peak Gain (dBi)	~2, ~4, ~3.5
Impedance (Ohm)	50
Polarisation	Linear
Radiation Pattern	Omni-Directional
Max. Input Power (W)	25

Antenna and electrical specifications

GPS/QZSS/Galileo/L1 (Connection 2)

Standards	GPS(L1)/QZSS(L1)/Galileo(E1)
Frequency (MHz)	1575.42
VSWR	<1.5:1
Impedance (Ohm)	50
Radiation Pattern	Hemispherical
Polarisation	RHCP
Active Gain (dB)	28 @ 2.7 V
Voltage (V)	1.5 – 3.6
Current Consumption (mA)	9 Typ
Power Consumption (mW)	24.3 Typ
Saw Filter Type	Pre-Filter

2J6041BGF Active GNSS 4GLTE/FirstNet/LPWA/NB-IoT/3G/2G & GPS/GLONASS/QZSS/Galileo/L1

- Key Features**
- ✔ Low Profile
 - ✔ Ground Plane Independent
 - ✔ Customizable Cable and Connector
 - ✔ Certificates: IP67 - Water Resistant
 - ✔ Pre-Filter GNSS



Standard colors.
Other colors upon request.

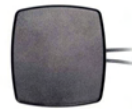

General specification

Mounting type	Screw mount
Dimensions (mm)	80 × 74 × 14.7
Operating temperature	-40 °C to +85 °C
Thread Length options	8.5mm, 19mm (Default), 30mm
Certificates	IP67

Antenna and electrical specifications

4GLTE/FirstNet/LPWA/NB-IoT/3G/2G (Connection 1)

Standards	4GLTE/FirstNet/LPWA/ CAT-X/CAT-Mx/CAT-NBx/NB-IoT/3G/2G
Frequency (MHz)	698-960, 1710-2170, 2500-2700
VSWR	~2.6:1, ~1.8:1, ~2.9:1
Efficiency (%)	~40.7, ~47.5, ~18.3
Peak Gain (dBi)	~1.8, ~5.0, ~-0.1
Impedance (Ohm)	50
Polarisation	Linear
Radiation Pattern	Omni-Directional
Max. Input Power (W)	25

Antenna and electrical specifications

GPS/GLONASS/QZSS/Galileo/L1 (Connection 2)

Standards	GPS(L1)/GLONASS(L1OF)/QZSS(L1)/Galileo(E1)
Frequency (MHz)	1575.42, 1598-1606
VSWR	<1.4:1
Impedance (Ohm)	50
Radiation Pattern	Hemispherical
Polarisation	RHCP
Active Gain (dB)	28 @ 2.7 V
Voltage (V)	1.5 – 3.6
Current Consumption (mA)	9 Typ
Power Consumption (mW)	24.3 Typ
Saw Filter Type	Pre-Filter
ESD Protection (kV)	6



2J6A41BGF Active GNSS 4GLTE/FirstNet/LPWA/NB-IoT/3G/2G & GPS/GLONASS/QZSS/Galileo/L1

- Key Features**
- ✔ Ground Plane Dependent
 - ✔ Pre-Filter GNSS
 - ✔ Certificates: IP67 - Water Resistant, IP69 - Hot Water Pressure, IK09 - Impact Resistant
 - ✔ Customizable Cable and Connector
 - ✔ Anti-rotation Mounting



Standard colors.
Other colors upon request.



General specification

Mounting type	Screw mount
Dimensions (mm)	Ø 77,3 × 65,5
Operating temperature	-40 °C to +85 °C
Certificates	IP67, IP69, IK09

Antenna and electrical specifications

4GLTE/FirstNet/LPWA/NB-IoT/3G/2G (Connection 1)

Standards	4GLTE/FirstNet/LPWA/ CAT-X/CAT-Mx/CAT-NBx/NB-IoT/3G/2G
Frequency (MHz)	698-960, 1710-2170, 2500-2700
VSWR	~2.1:1, ~1.5:1, ~1.5:1
Efficiency (%)	~52, ~62, ~50
Peak Gain (dBi)	~0.7, ~3.4, ~4.0
Impedance (Ohm)	50
Polarisation	Linear
Radiation Pattern	Omni-Directional
Max. Input Power (W)	25

Antenna and electrical specifications

GPS/GLONASS/QZSS/Galileo/L1 (Connection 2)

Standards	GPS(L1)/GLONASS(L10F)/QZSS(L1)/Galileo(E1)
Frequency (MHz)	1575.42, 1598-1606
VSWR	<1.5:1
Impedance (Ohm)	50
Radiation Pattern	Hemispherical
Polarisation	RHCP
Active Gain (dB)	28 @ 2.7 V
Voltage (V)	1.5 – 3.6
Current Consumption (mA)	9 Typ
Power Consumption (mW)	24.3 Typ
Saw Filter Type	Pre-Filter
ESD Protection (kV)	2

2J6941BGF Active GNSS 4GLTE/FirstNet/LPWA/NB-IoT/3G/2G & GPS/GLONASS/QZSS/Galileo/L1

- Key Features**
- ✔ Ground Plane Independent
 - ✔ Pre-Filter GNSS
 - ✔ Certificates: IP67 - Water Resistant, IP69 - Hot Water Pressure
 - ✔ Customizable Cable and Connector



Standard colors.
Other colors upon request.



General specification

Mounting type	Screw mount
Dimensions (mm)	80 × 76 × 25,6
Operating temperature	-40 °C to +85 °C
Certificates	IP67, IP69

Antenna and electrical specifications

4GLTE/FirstNet/LPWA/NB-IoT/3G/2G (Connection 1)

Standards	4GLTE/FirstNet/LPWA/ CAT-X/CAT-Mx/CAT-NBx/NB-IoT/3G/2G
Frequency (MHz)	698-960, 1710-2170, 2500-2700
VSWR	~2.1:1, ~2.7:1, ~1.3:1
Efficiency (%)	~45.9, ~50.3, ~64.1
Peak Gain (dBi)	~2.7, ~5.1, ~5.3
Impedance (Ohm)	50
Polarisation	Linear
Radiation Pattern	Omni-Directional
Max. Input Power (W)	25

Antenna and electrical specifications

GPS/GLONASS/QZSS/Galileo/L1 (Connection 2)

Standards	GPS(L1)/GLONASS(L10F)/QZSS(L1)/Galileo(E1)
Frequency (MHz)	1575.42, 1598-1606
VSWR	<1.4:1
Impedance (Ohm)	50
Radiation Pattern	Hemispherical
Polarisation	RHCP
Active Gain (dB)	28 @ 2.7 V
Voltage (V)	1.5 – 3.6
Current Consumption (mA)	9 Typ
Power Consumption (mW)	24.3 Typ
Saw Filter Type	Pre-Filter
ESD Protection (kV)	2



2J7541BG Active GNSS 4GLTE/FirstNet/LPWA/NB-IoT/3G/2G & GPS/GLONASS/QZSS/Galileo/L1

- Key Features**
- ✔ High Performance
 - ✔ Ground Plane Dependent
 - ✔ Certificates: IP67 - Water Resistant, IP69 - Hot Water Pressure
 - ✔ Customizable Cable and Connector
 - ✔ Anti-rotation Mounting
 - ✔ Pre-Filter GNSS



Standard colors.
Other colors upon request.

General specification

Mounting type	Screw mount
Dimensions (mm)	Ø 60 × 81
Operating temperature	-40 °C to +85 °C
Certificates	IP67, IP69

Antenna and electrical specifications

4GLTE/FirstNet/LPWA/NB-IoT/3G/2G (Connection 1)

Standards	4GLTE/FirstNet/LPWA/ CAT-X/CAT-Mx/CAT-NBx/NB-IoT/3G/2G
Frequency (MHz)	698-960, 1710-2170, 2500-2700
VSWR	~2.1:1, ~1.6:1, ~1.5:1
Efficiency (%)	~57, ~53, ~46
Peak Gain (dBi)	~1.3, ~2.0, ~2.6
Impedance (Ohm)	50
Polarisation	Linear
Radiation Pattern	Omni-Directional
Max. Input Power (W)	25

Antenna and electrical specifications

GPS/GLONASS/QZSS/Galileo/L1 (Connection 2)

Standards	GPS(L1)/GLONASS(L1OF)/QZSS(L1)/Galileo(E1)
Frequency (MHz)	1575.42, 1598-1606
VSWR	<1.2:1
Impedance (Ohm)	50
Radiation Pattern	Hemispherical
Polarisation	RHCP
Active Gain (dB)	26 @ 3V / 27dB @ 5V
Voltage (V)	2.7 - 5.5
Current Consumption (mA)	15 - 25
Power Consumption (mW)	40.5 - 137.5
Saw Filter Type	No Filter

2J7641BGF Active GNSS 4GLTE/FirstNet/LPWA/NB-IoT/3G/2G & GPS/GLONASS/QZSS/Galileo/L1

- Key Features**
- ✔ Ground Plane Independent
 - ✔ Pre-Filter GNSS
 - ✔ Certificates: IP67 - Water Resistant, IP69 - Hot Water Pressure
 - ✔ Customizable Cable and Connector



Standard colors.
Other colors upon request.

General specification

Mounting type	Screw mount
Dimensions (mm)	Ø 50 × 50.8
Operating temperature	-40 °C to +85 °C
Certificates	IP67, IP69

Antenna and electrical specifications

4GLTE/FirstNet/LPWA/NB-IoT/3G/2G (Connection 1)

Standards	4GLTE/FirstNet/LPWA/ CAT-X/CAT-Mx/CAT-NBx/NB-IoT/3G/2G
Frequency (MHz)	698-960, 1710-2170, 2500-2700
VSWR	~2.1:1, ~1.8:1, ~2.5:1
Efficiency (%)	~56.4, ~56.1, ~37.8
Peak Gain (dBi)	~2.6, ~3.2, ~1.4
Impedance (Ohm)	50
Polarisation	Linear
Radiation Pattern	Omni-Directional
Max. Input Power (W)	25

Antenna and electrical specifications

GPS/GLONASS/QZSS/Galileo/L1 (Connection 2)

Standards	GPS(L1)/GLONASS(L1OF)/QZSS(L1)/Galileo(E1)
Frequency (MHz)	1575.42, 1598-1606
VSWR	<1.4:1
Impedance (Ohm)	50
Radiation Pattern	Hemispherical
Polarisation	RHCP
Active Gain (dB)	28 @ 2.7 V
Voltage (V)	1.5 - 3.6
Current Consumption (mA)	9 Typ
Power Consumption (mW)	24.3 Typ
Saw Filter Type	Pre-Filter
ESD Protection (kV)	2



2J7741BGF Active GNSS 4GLTE/FirstNet/LPWA/NB-IoT/3G/2G & GPS/GLONASS/QZSS/Galileo/L1

- Key Features**
- ✔ High Performance
 - ✔ Ground Plane Dependent
 - ✔ Customizable Cable and Connector
 - ✔ Anti-Rotation Mounting
 - ✔ Certificates: IP67 - Water Resistant, IP69 - Hot Water Pressure, IK09 - Impact Resistant
 - ✔ Pre-Filter GNSS



General specification

Mounting type	Screw mount
Dimensions (mm)	Ø 60 × 69
Operating temperature	-40 °C to +85 °C
Certificates	IP67, IP69, IK09

Antenna and electrical specifications

4GLTE/FirstNet/LPWA/NB-IoT/3G/2G (Connection 1)	
Standards	4GLTE/FirstNet/LPWA/ CAT-X/CAT-Mx/CAT-NBx/NB-IoT/3G/2G
Frequency (MHz)	698-960, 1710-2170, 2500-2700
VSWR	~1.9:1, ~1.2:1, ~1.4:1
Efficiency (%)	~66.9, ~74.5, ~58.9
Peak Gain (dBi)	~1.9, ~4.3, ~4.2
Impedance (Ohm)	50
Polarisation	Linear
Radiation Pattern	Omni-Directional
Max. Input Power (W)	25

Antenna and electrical specifications

GPS/GLONASS/QZSS/Galileo/L1 (Connection 2)	
Standards	GPS(L1)/GLONASS(L10F)/QZSS(L1)/Galileo(E1)
Frequency (MHz)	1575.42, 1598-1606
VSWR	<1.4:1
Impedance (Ohm)	50
Radiation Pattern	Hemispherical
Polarisation	RHCP
Active Gain (dB)	28 @ 2.7 V
Voltage (V)	1.5 – 3.6
Current Consumption (mA)	9 Typ
Power Consumption (mW)	24.3 Typ
Saw Filter Type	Pre-Filter
ESD Protection (kV)	2

2J8741BGF Active GNSS 4GLTE/FirstNet/LPWA/NB-IoT/3G/2G & GPS/GLONASS/QZSS/Galileo/L1

- Key Features**
- ✔ Ground Plane Independent
 - ✔ Pre-Filter GNSS
 - ✔ Customizable Cable and Connector
 - ✔ Anti-Rotation Mounting
 - ✔ Certificates: IP67 - Water Resistant, IP69 - Hot Water Pressure, IK09 - Impact Resistant



General specification

Mounting type	Screw mount
Dimensions (mm)	102 × 63 × 63
Operating temperature	-40 °C to +85 °C
Certificates	IP67, IP69, IK09

Antenna and electrical specifications

4GLTE/FirstNet/LPWA/NB-IoT/3G/2G (Connection 1)	
Standards	4GLTE/FirstNet/LPWA/ CAT-X/CAT-Mx/CAT-NBx/NB-IoT/3G/2G
Frequency (MHz)	698-960, 1710-2170, 2500-2700
VSWR	~1.9:1, ~1.7:1, ~1.4:1
Efficiency (%)	~52.3, ~40.7, ~46.7
Peak Gain (dBi)	~1.2, ~2.0, ~3.1
Impedance (Ohm)	50
Polarisation	Linear
Radiation Pattern	Omni-Directional
Max. Input Power (W)	25

Antenna and electrical specifications

GPS/GLONASS/QZSS/Galileo/L1 (Connection 2)	
Standards	GPS(L1)/GLONASS(L10F)/QZSS(L1)/Galileo(E1)
Frequency (MHz)	1575.42, 1598-1606
VSWR	<1.4:1
Impedance (Ohm)	50
Radiation Pattern	Hemispherical
Polarisation	RHCP
Active Gain (dB)	28 @ 2.7 V
Voltage (V)	1.5 – 3.6
Current Consumption (mA)	9 Typ
Power Consumption (mW)	24.3 Typ
Saw Filter Type	Pre-Filter
ESD Protection (kV)	2



2J6047B

4GLTE/FirstNet/LPWA/NB-IoT/3G/2G & 2.4-5.0GHz/WiFi/LPWA/BT/ISM

- Key Features**
- ✔ Low Profile
 - ✔ Ground Plane Independent
 - ✔ Customizable Cable and Connector
 - ✔ Certificates: IP67 - Water Resistant



Standard colors.
Other colors upon request.

General specification

Mounting type	Screw mount
Dimensions (mm)	80 × 74 × 14.7
Operating temperature	-40 °C to +85 °C
Thread Length options	8.5mm, 19mm (Default), 30mm
Certificates	IP67

Antenna and electrical specifications

4GLTE/FirstNet/LPWA/NB-IoT/3G/2G (Connection 1)	
Standards	4GLTE/FirstNet/LPWA/ CAT-X/CAT-Mx/CAT-NBx/NB-IoT/3G/2G
Frequency (MHz)	698-960, 1710-2170, 2500-2700
VSWR	~2.4:1, ~2.4:1, ~1.4:1
Efficiency (%)	~26.2, ~37.1, ~54.8
Peak Gain (dBi)	~-0.3, ~-4.6, ~-6.2
Impedance (Ohm)	50
Polarisation	Linear
Radiation Pattern	Omni-Directional
Max. Input Power (W)	25

Antenna and electrical specifications

2.4-5.0GHz/WiFi/LPWA/BT/ISM (Connection 2)	
Standards	WiFi/Sigfox/LoRa/LPWA/Bluetooth/ BLE/ZigBee/RFID/RPMA/ISM
Frequency (MHz)	2410-2490, 4920-5925
VSWR	~1.8:1, ~1.5:1
Efficiency (%)	~43.4, ~31.9
Peak Gain (dBi)	~4.5, ~3.9
Impedance (Ohm)	50
Polarisation	Linear
Radiation Pattern	Omni-Directional
Max. Input Power (W)	25

2J6A47B

4GLTE/FirstNet/LPWA/NB-IoT/3G/2G & 2.4-5.0GHz/WiFi/LPWA/BT/ISM

- Key Features**
- ✔ Ground Plane Dependent
 - ✔ Customizable Cable and Connector
 - ✔ Certificates: IP67 - Water Resistant, IP69 - Hot Water Pressure, IK09 - Impact Resistant
 - ✔ Anti-rotation Mounting



Standard colors.
Other colors upon request.

General specification

Mounting type	Screw mount
Dimensions (mm)	∅ 77.3 × 65.5
Operating temperature	-40 °C to +85 °C
Certificates	IP67, IP69, IK09

Antenna and electrical specifications

4GLTE/FirstNet/LPWA/NB-IoT/3G/2G (Connection 1)	
Standards	4GLTE/FirstNet/LPWA/ CAT-X/CAT-Mx/CAT-NBx/NB-IoT/3G/2G
Frequency (MHz)	698-960, 1710-2170, 2500-2700
VSWR	~2.1:1, ~1.5:1, ~1.5:1
Efficiency (%)	~52, ~62, ~50
Peak Gain (dBi)	~-0.7, ~-3.4, ~-4.0
Impedance (Ohm)	50
Polarisation	Linear
Radiation Pattern	Omni-Directional
Max. Input Power (W)	25

Antenna and electrical specifications

2.4-5.0GHz/WiFi/LPWA/BT/ISM (Connection 2)	
Standards	WiFi/Sigfox/LoRa/LPWA/Bluetooth/ BLE/ZigBee/RFID/RPMA/ISM
Frequency (MHz)	2410-2490, 4920-5925
VSWR	~1.2:1, ~1.8:1
Efficiency (%)	~60.5, ~38.4
Peak Gain (dBi)	~5.0, ~3.9
Impedance (Ohm)	50
Polarisation	Linear
Radiation Pattern	Omni-Directional
Max. Input Power (W)	25



2J7747B

4GLTE/FirstNet/LPWA/NB-IoT/3G/2G & 2.4-5.0GHz/WiFi/LPWA/BT/ISM

- Key Features**
- ✔ High Performance
 - ✔ Ground Plane Dependent
 - ✔ Customizable Cable and Connector
 - ✔ Anti-Rotation Mounting
 - ✔ Certificates: IP67 - Water Resistant, IP69 - Hot Water Pressure, IK09 - Impact Resistant



White Black
Standard colors.
Other colors upon request.

- Key Features**
- ✔ Ground Plane Dependent
 - ✔ Customizable Cable and Connector
 - ✔ Certificates: IP67 - Water Resistant, IP69 - Hot Water Pressure, IK09 - Impact Resistant

General specification

Mounting type	Screw mount
Dimensions (mm)	Ø 60 × 69
Operating temperature	-40 °C to +85 °C
Certificates	IP67, IP69, IK09

Antenna and electrical specifications

4GLTE/FirstNet/LPWA/NB-IoT/3G/2G (Connection 1)

Standards	4GLTE/FirstNet/LPWA/ CAT-X/CAT-Mx/CAT-NBx/NB-IoT/3G/2G
Frequency (MHz)	698-960, 1710-2170, 2500-2700
VSWR	~2.1:1, ~1.4:1, ~2.1:1
Efficiency (%)	~61.4, ~61.9, ~42.4
Peak Gain (dBi)	~2.2, ~3.7, ~3.2
Impedance (Ohm)	50
Polarisation	Linear
Radiation Pattern	Omni-Directional
Max. Input Power (W)	25

Antenna and electrical specifications

2.4-5.0GHz/WiFi/LPWA/BT/ISM (Connection 2)

Standards	WiFi/Sigfox/LoRa/LPWA/Bluetooth/ BLE/ZigBee/RFID/RFMA/ISM
Frequency (MHz)	2410-2490, 4920-5925
VSWR	~1.7:1, ~1.8:1
Efficiency (%)	~57.4, ~43.6
Peak Gain (dBi)	~4.5, ~4.8
Impedance (Ohm)	50
Polarisation	Linear
Radiation Pattern	Omni-Directional
Max. Input Power (W)	25

2J4700BGF Active GNSS

3G/2G/CELLULAR & GPS/GLONASS/QZSS/Galileo/L1

- Key Features**
- ✔ Ground Plane Dependent
 - ✔ Customizable Cable and Connector
 - ✔ Low Profile
 - ✔ Certificates: IP69 - Hot Water Pressure
 - ✔ Pre-Filter GNSS



White Black
Standard colors.
Other colors upon request.

General specification

Mounting type	Screw mount
Dimensions (mm)	Ø 52 × 17.5
Operating temperature	-40 °C to +85 °C
Thread Length options	8.5mm, 19mm (Default), 30mm
Certificates	IP69

Antenna and electrical specifications

3G/2G/CELLULAR (Connection 1)

Standards	3G/Cellular/HSPA/UMTS/WCDA/ EDGE/EGPRS/GRPS/GSM/CDMA/2G
Frequency (MHz)	824-960, 1710-2170
VSWR	~1.9:1, ~1.7:1
Efficiency (%)	~20.6, ~20.5
Peak Gain (dBi)	~-0.3, ~-2.0
Impedance (Ohm)	50
Polarisation	Linear
Radiation Pattern	Omni-Directional
Max. Input Power (W)	100

Antenna and electrical specifications

GPS/GLONASS/QZSS/Galileo/L1 (Connection 2)

Standards	GPS(L1)/GLONASS(L10F)/QZSS(L1)/Galileo(E1)
Frequency (MHz)	1575.42, 1598-1606
VSWR	<1.4:1
Impedance (Ohm)	50
Radiation Pattern	Hemispherical
Polarisation	RHCP
Active Gain (dB)	28 @ 2.7 V
Voltage (V)	1.5 - 3.6
Current Consumption (mA)	9 @ 2.7 V
Saw Filter Type	Pre-Filter
Out of Band Rejection (dB)	~43
ESD Protection (kV)	6



2J6500BGF Active GNSS 3G/2G/CELLULAR & GPS/GLONASS/QZSS/Galileo/L1

- Key Features**
- ✔ Ground Plane Dependent
 - ✔ Customizable Cable and Connector
 - ✔ Certificates: IP67 - Water Resistant, IP69 - Hot Water Pressure, IK09 - Impact Resistant
 - ✔ Pre-Filter GNSS
 - ✔ Anti-rotation Mounting



Standard colors.
Other colors upon request.



General specification

Mounting type	Screw mount
Dimensions (mm)	Ø 146 × 31.5
Operating temperature	-40 °C to +85 °C
Certificates	IP67, IP69, IK09

Antenna and electrical specifications

3G/2G/CELLULAR (Connection 1)	
Standards	3G/Cellular/HSPA/UMTS/WCDA/ EDGE/EGPRS/GRPS/GSM/CDMA/2G
Frequency (MHz)	824-960, 1710-2170
VSWR	~2.1:1, ~1.7:1
Efficiency (%)	~43, ~38
Peak Gain (dBi)	~1.8, ~2.3
Impedance (Ohm)	50
Polarisation	Linear
Radiation Pattern	Omnio-Directional
Max. Input Power (W)	25

Antenna and electrical specifications

GPS/GLONASS/QZSS/Galileo/L1 (Connection 2)	
Standards	GPS(L1)/GLONASS(L10F)/QZSS(L1)/Galileo(E1)
Frequency (MHz)	1575.42, 1598-1606
VSWR	~1.4:1
Impedance (Ohm)	50
Radiation Pattern	Hemispherical
Polarisation	RHCP
Active Gain (dB)	28 @ 2.7 V
Voltage (V)	1.5 - 3.6
Current Consumption (mA)	9 @ 2.7 V
Power Consumption (mW)	24.3 Typ
Saw Filter Type	Pre-Filter
ESD Protection (kV)	6

2J6600BGF Active GNSS 3G/2G/CELLULAR & GPS/GLONASS/QZSS/Galileo/L1

- Key Features**
- ✔ Low Profile
 - ✔ Ground Plane Dependent
 - ✔ Customizable Cable and Connector
 - ✔ Anti-rotation Mounting
 - ✔ Certificates: IP67 - Water Resistant, IP69 - Hot Water Pressure
 - ✔ Pre-Filter GNSS



Standard colors.
Other colors upon request.



General specification

Mounting type	Screw mount
Dimensions (mm)	Ø 77.3 × 15
Operating temperature	-40 °C to +85 °C
Certificates	IP67, IP69

Antenna and electrical specifications

3G/2G/CELLULAR (Connection 1)	
Standards	3G/Cellular/HSPA/UMTS/WCDA/ EDGE/EGPRS/GRPS/GSM/CDMA/2G
Frequency (MHz)	824-960, 1710-2170
VSWR	~2.7:1, ~2.1:1
Efficiency (%)	~17.6, ~11.4
Peak Gain (dBi)	~-3.6, ~-3.3
Impedance (Ohm)	50
Polarisation	Linear
Radiation Pattern	Omnio-Directional
Max. Input Power (W)	100

Antenna and electrical specifications

GPS/GLONASS/QZSS/Galileo/L1 (Connection 2)	
Standards	GPS(L1)/GLONASS(L10F)/QZSS(L1)/Galileo(E1)
Frequency (MHz)	1575.42, 1598-1606
VSWR	<1.4:1
Impedance (Ohm)	50
Radiation Pattern	Hemispherical
Polarisation	RHCP
Active Gain (dB)	26 @ 3V / 27dB @ 5V
Voltage (V)	2.7 - 5.5
Current Consumption (mA)	15 - 25
Power Consumption (mW)	40.5 - 137.5
Saw Filter Type	Pre-Filter



2J6700BGF Active GNSS 3G/2G/CELLULAR & GPS/GLONASS/QZSS/Galileo/L1

- Key Features**
- ✔ Low Profile
 - ✔ Ground Plane Dependent
 - ✔ Customizable Cable and Connector
 - ✔ Anti-rotation Mounting
 - ✔ Certificates: IP67 - Water Resistant, IP69 - Hot Water Pressure, IK09 - Impact Resistant
 - ✔ Pre-Filter GNSS



Standard colors.
Other colors upon request.

General specification

Mounting type	Screw mount
Dimensions (mm)	Ø 77,3 × 36,5
Operating temperature	-40 °C to +85 °C
Certificates	IP67, IP69, IK09

Antenna and electrical specifications

3G/2G/CELLULAR (Connection 1)

Standards	3G/Cellular/HSPA/UMTS/WCDA/ EDGE/EGPRS/GRPS/GSM/CDMA/2G
Frequency (MHz)	824-960, 1710-2170
VSWR	~2.8:1, ~2.1:1
Efficiency (%)	~19.5, ~14.1
Peak Gain (dBi)	~-3.2, ~-2.1
Impedance (Ohm)	50
Polarisation	Linear
Radiation Pattern	Omni-Directional
Max. Input Power (W)	25

Antenna and electrical specifications

GPS/GLONASS/QZSS/Galileo/L1 (Connection 2)

Standards	GPS(L1)/GLONASS(L10F)/QZSS(L1)/Galileo(E1)
Frequency (MHz)	1575.42, 1598-1606
VSWR	~1.4:1
Impedance (Ohm)	50
Radiation Pattern	Hemispherical
Polarisation	RHCP
Active Gain (dB)	28 @ 2.7 V
Voltage (V)	1.5 - 3.6
Current Consumption (mA)	9 @ 2.7 V
Power Consumption (mW)	24.3 Typ
Saw Filter Type	Pre-Filter
ESD Protection (kV)	6

2J8600BGF Active GNSS 3G/2G/CELLULAR & GPS/GLONASS/QZSS/Galileo/L1

- Key Features**
- ✔ Ground Plane Dependent
 - ✔ Anti-rotation Mounting
 - ✔ Customizable Cable and Connector
 - ✔ Pre-Filter GNSS
 - ✔ Certificates: IP67 - Water Resistant, IP69 - Hot Water Pressure



Standard colors.
Other colors upon request.

General specification

Mounting type	Screw mount
Dimensions (mm)	99 × 60 × 46
Operating temperature	-40 °C to +85 °C
Certificates	IP67, IP69

Antenna and electrical specifications

3G/2G/CELLULAR (Connection 1)

Standards	3G/Cellular/HSPA/UMTS/WCDA/ EDGE/EGPRS/GRPS/GSM/CDMA/2G
Frequency (MHz)	824-960, 1710-2170
VSWR	~2.5:1, ~1.6:1
Efficiency (%)	~7.7, ~12.2
Peak Gain (dBi)	~-6.7, ~-3.9
Impedance (Ohm)	50
Polarisation	Linear
Radiation Pattern	Omni-Directional
Max. Input Power (W)	25

Antenna and electrical specifications

GPS/GLONASS/QZSS/Galileo/L1 (Connection 2)

Standards	GPS(L1)/GLONASS(L10F)/QZSS(L1)/Galileo(E1)
Frequency (MHz)	1575.42, 1598-1606
VSWR	<1.2:1
Impedance (Ohm)	50
Radiation Pattern	Hemispherical
Polarisation	RHCP
Active Gain (dB)	23 @ 3 V, 24 @ 5 V
Voltage (V)	2.7 - 5.5
Current Consumption (mA)	15 - 25
Power Consumption (mW)	40.5 - 137.5
Saw Filter Type	Pre-Filter
ESD Protection (kV)	2



2J6605B

3G/2G/CELLULAR & 2.4-5.0GHz/WiFi/LPWA/BT/ISM

- Key Features**
- ✔ Low Profile
 - ✔ Ground Plane Dependent
 - ✔ Customizable Cable and Connector
 - ✔ Anti-rotation Mounting
 - ✔ Certificates: IP67 - Water Resistant, IP69 - Hot Water Pressure



Standard colors.
Other colors upon request.

General specification

Mounting type	Screw mount
Dimensions (mm)	Ø 77.3 × 15
Operating temperature	-40 °C to +85 °C
Certificates	IP67, IP69

Antenna and electrical specifications

3G/2G/CELLULAR (Connection 1)

Standards	3G/Cellular/HSPA/UMTS/WCDA/EDGE/EGPRS/GRPS/GSM/CDMA/2G
Frequency (MHz)	824-960, 1710-2170
VSWR	~2.7:1, ~1.9:1
Efficiency (%)	~19.0, ~16.9
Peak Gain (dBi)	~-3.0, ~-1.4
Impedance (Ohm)	50
Polarisation	Linear
Radiation Pattern	Omn-Directional
Max. Input Power (W)	100

Antenna and electrical specifications

2.4-5.0GHz/WiFi/LPWA/BT/ISM (Connection 2)

Standards	WiFi/Sigfox/LoRa/LPWA/Bluetooth/BLE/ZigBee/RFID/MPMA/ISM
Frequency (MHz)	2410-2490, 4920-5925
VSWR	~1.4:1, ~1.4:1
Efficiency (%)	~18.2, ~10.0
Peak Gain (dBi)	~-1.6, ~-2.0
Impedance (Ohm)	50
Polarisation	Linear
Radiation Pattern	Omn-Directional
Max. Input Power (W)	25

2J6603B Active GNSS

GPS/QZSS/Galileo/L1 & 2.4-5.0GHz/WiFi/LPWA/BT/ISM

- Key Features**
- ✔ Low Profile
 - ✔ Ground Plane Independent
 - ✔ Customizable Cable and Connector
 - ✔ Anti-rotation Mounting
 - ✔ Certificates: IP67 - Water Resistant, IP69 - Hot Water Pressure



Standard colors.
Other colors upon request.

General specification

Mounting type	Screw mount
Dimensions (mm)	Ø 77.3 × 15
Operating temperature	-40 °C to +85 °C
Certificates	IP67, IP69

Antenna and electrical specifications

GPS/QZSS/Galileo/L1 (Connection 1)

Standards	GPS(L1)/QZSS(L1)/Galileo(E1)
Frequency (MHz)	1575.42
VSWR	<1.2:1
Impedance (Ohm)	50
Radiation Pattern	Hemispherical
Polarisation	RHCP
Active Gain (dB)	26 @ 3V
Voltage (V)	3 - 5
Current Consumption (mA)	15 - 25
Power Consumption (mW)	45 - 125

Antenna and electrical specifications

2.4-5.0GHz/WiFi/LPWA/BT/ISM (Connection 2)

Standards	WiFi/Sigfox/LoRa/LPWA/Bluetooth/BLE/ZigBee/RFID/MPMA/ISM
Frequency (MHz)	2410-2490, 4920-5925
VSWR	~1.2:1, ~1.4:1
Efficiency (%)	~35, ~33
Peak Gain (dBi)	~-4.3, ~-1.8
Impedance (Ohm)	50
Polarisation	Linear
Radiation Pattern	Omn-Directional
Max. Input Power (W)	25



2J6703B Active GNSS

GPS/QZSS/Galileo/L1 & 2.4-5.0GHz/WiFi/LPWA/BT/ISM

- Key Features**
- ✔ Low Profile
 - ✔ Ground Plane Dependent
 - ✔ Customizable Cable and Connector
 - ✔ Anti-rotation Mounting
 - ✔ Certificates: IP67 - Water Resistant, IP69 - Hot Water Pressure, IK09 - Impact Resistant



White Black
Standard colors.
Other colors upon request.

General specification

Mounting type	Screw mount
Dimensions (mm)	Ø 77.3 × 36.5
Operating temperature	-40 °C to +85 °C
Certificates	IP67, IP69, IK09

Antenna and electrical specifications

GPS/QZSS/Galileo/L1 (Connection 1)

Standards	GPS(L1)/QZSS(L1)/Galileo(E1)
Frequency (MHz)	1575.42
VSWR	<1.2:1
Impedance (Ohm)	50
Radiation Pattern	Hemispherical
Polarisation	RHCP
Active Gain (dB)	26 @ 3V
Voltage (V)	3 - 5
Current Consumption (mA)	15 - 25
Power Consumption (mW)	45 - 125

Antenna and electrical specifications

2.4-5.0GHz/WiFi/LPWA/BT/ISM (Connection 2)

Standards	WiFi/Sigfox/LoRa/LPWA/Bluetooth/ BLE/ZigBee/RFID/RPMA/ISM
Frequency (MHz)	2410-2490, 4920-5925
VSWR	~1.2:1, ~1.4:1
Efficiency (%)	~35, ~33
Peak Gain (dBi)	~4.3, ~1.8
Impedance (Ohm)	50
Polarisation	Linear
Radiation Pattern	Omni-Directional
Max. Input Power (W)	25

2J7807BG-433 Active GNSS

GPS/GLONASS/QZSS/Galileo/L1 & 433MHz/LPWA/RFID/ZigBee/ISM

- Key Features**
- ✔ Ground Plane Dependent
 - ✔ Customizable Cable and Connector
 - ✔ Certificates: IP67 - Water Resistant, IP69 - Hot Water Pressure
 - ✔ Anti-rotation Mounting



White Black
Standard colors.
Other colors upon request.

General specification

Mounting type	Screw mount
Dimensions (mm)	Ø 63 × 186.5
Operating temperature	-40 °C to +85 °C
Certificates	IP67, IP69

Antenna and electrical specifications

GPS/GLONASS/QZSS/Galileo/L1 (Connection 1)

Standards	GPS(L1)/GLONASS(L1OF)/QZSS(L1)/Galileo(E1)
Frequency (MHz)	1575.42, 1598-1606
VSWR	<1.2:1
Impedance (Ohm)	50
Radiation Pattern	Hemispherical
Polarisation	RHCP
Active Gain (dB)	26 @ 3V / 27dB @ 5V
Voltage (V)	2.7 - 5.5
Current Consumption (mA)	15 - 25
Power Consumption (mW)	40.5 - 137.5

Antenna and electrical specifications

433MHz/LPWA/RFID/ZigBee/ISM (Connection 2)

Standards	Sigfox/LoRa/RFID/LPWA/ISM/UHF
Frequency (MHz)	433-435
VSWR	~1.7:1
Efficiency (%)	~51
Peak Gain (dBi)	~-0.4
Impedance (Ohm)	50
Polarisation	Linear
Radiation Pattern	Omni-Directional
Max. Input Power (W)	50



2J6639BGF-868 Active GNSS

GPS/GLONASS/QZSS/Galileo/L1 & 868MHz/Sigfox/LoRa/LPWA/RFID/ZigBee/ISM

- Key Features**
- ✔ Low Profile
 - ✔ Ground Plane Dependent
 - ✔ High Gain
 - ✔ Customizable Cable and Connector
 - ✔ Anti-rotation Mounting
 - ✔ Pre-Filter GNSS
 - ✔ Certificates: IP67 - Water Resistant, IP69 - Hot Water Pressure



Standard colors.
Other colors upon request.

General specification

Mounting type	Screw mount
Dimensions (mm)	Ø 77.3 × 15
Operating temperature	-40 °C to +85 °C
Certificates	IP67, IP69

Antenna and electrical specifications

GPS/GLONASS/QZSS/Galileo/L1 (Connection 1)

Standards	GPS(L1)/GLONASS(L1OF)/QZSS(L1)/Galileo(E1)
Frequency (MHz)	1575.42, 1598-1606
VSWR	~1.4:1
Impedance (Ohm)	50
Radiation Pattern	Hemispherical
Polarisation	RHCP
Active Gain (dB)	28 @ 2.7 V
Voltage (V)	1.5 – 3.6
Current Consumption (mA)	9 Typ
Power Consumption (mW)	24.3 Typ
Saw Filter Type	Pre-Filter
ESD Protection (kV)	2

Antenna and electrical specifications

868MHz/Sigfox/LoRa/LPWA/RFID/ZigBee/ISM (Connection 2)

Standards	Sigfox/LoRa/ZigBee/RFID/LPWA/ISM/UHF
Frequency (MHz)	863-870
VSWR	~1.5:1
Efficiency (%)	~51.7
Peak Gain (dBi)	~3.2
Impedance (Ohm)	50
Polarisation	Linear
Radiation Pattern	Omni-Directional
Max. Input Power (W)	25

2J6639BGF-915 Active GNSS

GPS/GLONASS/QZSS/Galileo/L1 & 915MHz/Sigfox/LoRa/LPWA/RFID/ZigBee/ISM

- Key Features**
- ✔ Low Profile
 - ✔ Ground Plane Dependent
 - ✔ High Gain
 - ✔ Customizable Cable and Connector
 - ✔ Anti-rotation Mounting
 - ✔ Pre-Filter GNSS
 - ✔ Certificates: IP67 - Water Resistant, IP69 - Hot Water Pressure



Standard colors.
Other colors upon request.

General specification

Mounting type	Screw mount
Dimensions (mm)	Ø 77.3 × 15
Operating temperature	-40 °C to +85 °C
Certificates	IP67, IP69

Antenna and electrical specifications

GPS/GLONASS/QZSS/Galileo/L1 (Connection 1)

Standards	GPS(L1)/GLONASS(L1OF)/QZSS(L1)/Galileo(E1)
Frequency (MHz)	1575.42, 1598-1606
VSWR	~1.4:1
Impedance (Ohm)	50
Radiation Pattern	Hemispherical
Polarisation	RHCP
Active Gain (dB)	28 @ 2.7 V
Voltage (V)	1.5 – 3.6
Current Consumption (mA)	9 Typ
Power Consumption (mW)	24.3 Typ
Saw Filter Type	Pre-Filter
ESD Protection (kV)	2

Antenna and electrical specifications

915MHz/Sigfox/LoRa/LPWA/RFID/ZigBee/ISM (Connection 2)

Standards	Sigfox/LoRa/ZigBee/RFID/LPWA/ISM/UHF
Frequency (MHz)	902-928
VSWR	~1.2:1
Efficiency (%)	~51
Peak Gain (dBi)	~3.7
Impedance (Ohm)	50
Polarisation	Linear
Radiation Pattern	Omni-Directional
Max. Input Power (W)	25



2J7239BG-915 Active GNSS GPS/GLONASS/QZSS/Galileo/L1 & 915MHz/Sigfox/LoRa/LPWA/RFID/ZigBee/ISM

- Key Features**
- ✔ High Performance
 - ✔ Ground Plane Dependent
 - ✔ Customizable Cable and Connector
 - ✔ Anti-rotation Mounting
 - ✔ Certificates: IP67 - Water Resistant, IP69 - Hot Water Pressure



Standard colors.
Other colors upon request.



General specification

Mounting type	Screw mount
Dimensions (mm)	Ø 60 × 97
Operating temperature	-40 °C to +85 °C
Certificates	IP67, IP69

Antenna and electrical specifications

GPS/GLONASS/QZSS/Galileo/L1 (Connection 1)

Standards	GPS(L1)/GLONASS(L1OF)/QZSS(L1)/Galileo(E1)
Frequency (MHz)	1575.42, 1598-1606
VSWR	<1.2:1
Impedance (Ohm)	50
Radiation Pattern	Hemispherical
Polarisation	RHCP
Active Gain (dB)	26 @ 3V / 27dB @ 5V
Voltage (V)	2.7 - 5.5
Current Consumption (mA)	15 - 25
Power Consumption (mW)	40.5 - 137.5

Antenna and electrical specifications

915MHz/Sigfox/LoRa/LPWA/RFID/ZigBee/ISM (Connection 2)

Standards	Sigfox/LoRa/ZigBee/RFID/LPWA/ISM/UHF
Frequency (MHz)	902-928
VSWR	~1.1:1
Efficiency (%)	~56
Peak Gain (dBi)	~1.9
Impedance (Ohm)	50
Polarisation	Linear
Radiation Pattern	Omni-Directional
Max. Input Power (W)	25

2J8407BGF Active GNSS GPS/GLONASS/QZSS/Galileo/L1 & 380-470MHz/LPWA/TETRA/UHF

- Key Features**
- ✔ Ground Plane Dependent
 - ✔ Anti-rotation Mounting
 - ✔ Customizable Cable and Connector
 - ✔ Certificates: IP67 - Water Resistant
 - ✔ Pre-Filter GNSS



Standard colors.
Other colors upon request.

General specification

Mounting type	Screw mount
Dimensions (mm)	59.6 × 153.1 × 172.4
Operating temperature	-40 °C to +85 °C
Certificates	IP67

Antenna and electrical specifications

GPS/GLONASS/QZSS/Galileo/L1 (Connection 1)

Standards	GPS(L1)/GLONASS(L1OF)/QZSS(L1)/Galileo(E1)
Frequency (MHz)	1575.42, 1598-1606
VSWR	<1.2:1
Impedance (Ohm)	50
Radiation Pattern	Hemispherical
Polarisation	RHCP
Active Gain (dB)	26 @ 3 V, 27 @ 5 V
Voltage (V)	2.7 - 5.5
Current Consumption (mA)	15 - 25
Power Consumption (mW)	40.5 - 137.5
Saw Filter Type	Pre-Filter
ESD Protection (kV)	2

Antenna and electrical specifications

380-470MHz/LPWA/TETRA/UHF (Connection 2)

Standards	TETRA/UHF/PMR/LMR
Frequency (MHz)	380-470
VSWR	~2.5:1
Efficiency (%)	~56.5
Peak Gain (dBi)	~2.0
Impedance (Ohm)	50
Polarisation	Linear
Radiation Pattern	Omni-Directional
Max. Input Power (W)	25



2J7225BG Active GNSS GPS/GLONASS/QZSS/Galileo/L1 & 169MHz/ERMES/VHF

- Key Features**
- ✔ High Performance
 - ✔ Ground Plane Dependent
 - ✔ Customizable Cable and Connector
 - ✔ Anti-rotation Mounting
 - ✔ Certificates: IP67 - Water Resistant, IP69 - Hot Water Pressure



Standard colors.
Other colors upon request.



General specification

Mounting type	Screw mount
Dimensions (mm)	Ø 60 × 97
Operating temperature	-40 °C to +85 °C
Certificates	IP67, IP69

Antenna and electrical specifications

GPS/GLONASS/QZSS/Galileo/L1 (Connection 1)

Standards	GPS(L1)/GLONASS(L10F)/QZSS(L1)/Galileo(E1)
Frequency (MHz)	1575.42, 1598-1606
VSWR	<1.2:1
Impedance (Ohm)	50
Radiation Pattern	Hemispherical
Polarisation	RHCP
Active Gain (dB)	26 @ 3V / 27dB @ 5V
Voltage (V)	2.7 - 5.5
Current Consumption (mA)	15 - 25
Power Consumption (mW)	40.5 - 137.5
ESD Protection (kV)	2

Antenna and electrical specifications

169MHz/ERMES/VHF (Connection 2)

Standards	169MHz/ERMES/VHF
Frequency (MHz)	169
VSWR	~1.6:1
Impedance (Ohm)	50
Polarisation	Linear
Radiation Pattern	Omni-Directional
Max. Input Power (W)	25

2J7929BGF Active GNSS GPS/GLONASS/QZSS/Galileo/L1 & ORBCOMM

- Key Features**
- ✔ High Performance
 - ✔ Ground Plane Dependent
 - ✔ Certificates: IP67 - Water Resistant, IP69 - Hot Water Pressure
 - ✔ Customizable Cable and Connector
 - ✔ Pre-Filter GNSS
 - ✔ Anti-rotation Mounting



Standard colors.
Other colors upon request.



General specification

Mounting type	Screw mount
Dimensions (mm)	Ø 60 × 410.4
Operating temperature	-40 °C to +85 °C
Certificates	IP67, IP69

Antenna and electrical specifications

GPS/GLONASS/QZSS/Galileo/L1 (Connection 1)

Standards	GPS(L1)/GLONASS(L10F)/QZSS(L1)/Galileo(E1)
Frequency (MHz)	1575.42, 1598-1606
VSWR	<1.4:1
Impedance (Ohm)	50
Radiation Pattern	Hemispherical
Polarisation	RHCP
Active Gain (dB)	26 @ 3V / 27dB @ 5V
Voltage (V)	2.7 - 5.5
Current Consumption (mA)	15 - 25
Power Consumption (mW)	40.5 - 137.5
Saw Filter Type	Pre-Filter
ESD Protection (kV)	2

Antenna and electrical specifications

ORBCOMM (Connection 2)

Standards	ORBCOMM
Frequency (MHz)	137-150
VSWR	~2.2:1
Impedance (Ohm)	50
Polarisation	Linear
Radiation Pattern	Omni-Directional
Max. Input Power (W)	25



2J8344BGF Active GNSS GPS/GLONASS/QZSS/Galileo/L1 & FM

- Key Features**
- ✔ Ground Plane Dependent
 - ✔ Anti-rotation Mounting
 - ✔ Customizable Cable and Connector
 - ✔ Certificates: IP67 - Water Resistant
 - ✔ Pre-Filter GNSS



General specification

Mounting type	Screw mount
Dimensions (mm)	60 × 143 × 137
Operating temperature	-40 °C to +85 °C
Certificates	IP67

Antenna and electrical specifications

GPS/GLONASS/QZSS/Galileo/L1 (Connection 1)

Standards	GPS(L1)/GLONASS(L1OF)/QZSS(L1)/Galileo(E1)
Frequency (MHz)	1575.42, 1598-1606
VSWR	<1.4:1
Impedance (Ohm)	50
Radiation Pattern	Hemispherical
Polarisation	RHCP
Active Gain (dB)	23 @ 3V / 24dB @ 5V
Voltage (V)	2.7 - 5.5
Current Consumption (mA)	15 - 25
Power Consumption (mW)	40.5 - 137.5
Saw Filter Type	Pre-Filter
ESD Protection (kV)	2

Antenna and electrical specifications

FM (Connection 2)

Standards	FM
Frequency (MHz)	88-108
VSWR	~2.2:1
Impedance (Ohm)	75
Polarisation	Linear
Radiation Pattern	Hemispherical
Active Gain (dB)	5 - 10
Voltage (V)	12 - 15

2J6033BGF Active GNSS iridium certified antenna GPS/GLONASS/QZSS/Galileo/L1 & IRIDIUM

- Key Features**
- ✔ Low Profile
 - ✔ Ground Plane Independent
 - ✔ Customizable Cable and Connector
 - ✔ Certificates: IP67 - Water Resistant
 - ✔ Pre-Filter GNSS



General specification

Mounting type	Screw mount
Dimensions (mm)	80 × 74 × 14.7
Operating temperature	-40 °C to +85 °C
Thread Length options	8.5mm, 19mm (Default), 30mm
Certificates	IP67

Antenna and electrical specifications

GPS/GLONASS/QZSS/Galileo/L1 (Connection 1)

Standards	GPS(L1)/GLONASS(L1OF)/QZSS(L1)/Galileo(E1)
Frequency (MHz)	1575.42, 1598-1606
VSWR	<1.4:1
Impedance (Ohm)	50
Radiation Pattern	Hemispherical
Polarisation	RHCP
Active Gain (dB)	28 @ 2.7 V
Voltage (V)	1.5 - 3.6
Current Consumption (mA)	9 Typ
Power Consumption (mW)	24.3 Typ
Saw Filter Type	Pre-Filter
ESD Protection (kV)	2

Antenna and electrical specifications

IRIDIUM (Connection 2)

Standards	IRIDIUM
Frequency (MHz)	1616-1627
VSWR	~1.2:1
Efficiency (%)	~76
Peak Gain (dBi)	~4.5
Impedance (Ohm)	50
Polarisation	RHCP
Radiation Pattern	Hemispherical
Axial Ratio (dB)	3 max.



2J6533BGF Active GNSS GPS/GLONASS/QZSS/Galileo/L1 & IRIDIUM

- Key Features**
- ✔ Ground Plane Dependent
 - ✔ Customizable Cable and Connector
 - ✔ Certificates: IP67 - Water Resistant, IP69 - Hot Water Pressure, IK09 - Impact Resistant
 - ✔ Anti-rotation Mounting
 - ✔ Pre-Filter GNSS



Standard colors.
Other colors upon request.

General specification

Mounting type	Screw mount
Dimensions (mm)	Ø 146 × 31.5
Operating temperature	-40 °C to +85 °C
Certificates	IP67, IP69, IK09

Antenna and electrical specifications

GPS/GLONASS/QZSS/Galileo/L1 (Connection 1)	
Standards	GPS(L1)/GLONASS(L1OF)/QZSS(L1)/Galileo(E1)
Frequency (MHz)	1575.42, 1598-1606
VSWR	~1.4:1
Impedance (Ohm)	50
Radiation Pattern	Hemispherical
Polarisation	RHCP
Active Gain (dB)	28 @ 2.7 V
Voltage (V)	1.5 – 3.6
Current Consumption (mA)	9 @ 2.7 V
Power Consumption (mW)	24.3 Typ
Saw Filter Type	Pre-Filter
ESD Protection (kV)	6

Antenna and electrical specifications

IRIDIUM (Connection 2)	
Standards	IRIDIUM
Frequency (MHz)	1616-1627
VSWR	~1.2:1
Efficiency (%)	~76
Peak Gain (dBi)	~4.5
Impedance (Ohm)	50
Polarisation	RHCP
Radiation Pattern	Hemispherical
Axial Ratio (dB)	3 max.

2J6933BGFz Active GNSS GPS/GLONASS/QZSS/Galileo/L1 & IRIDIUM

- Key Features**
- ✔ Ground Plane Independent
 - ✔ Pre-Filter GNSS
 - ✔ Certificates: IP67 - Water Resistant, IP69 - Hot Water Pressure
 - ✔ Customizable Cable and Connector



Standard colors.
Other colors upon request.

General specification

Mounting type	Screw mount
Dimensions (mm)	80 × 76 × 25.6
Operating temperature	-40 °C to +85 °C
Certificates	IP67, IP69

Antenna and electrical specifications

GPS/GLONASS/QZSS/Galileo/L1 (Connection 1)	
Standards	GPS(L1)/GLONASS(L1OF)/QZSS(L1)/Galileo(E1)
Frequency (MHz)	1575.42, 1598-1606
VSWR	<1.4:1
Impedance (Ohm)	50
Radiation Pattern	Hemispherical
Polarisation	RHCP
Active Gain (dB)	28 @ 2.7 V
Voltage (V)	1.5 – 3.6
Current Consumption (mA)	9 Typ
Power Consumption (mW)	24.3 Typ
Saw Filter Type	Pre-Filter
ESD Protection (kV)	2

Antenna and electrical specifications

IRIDIUM (Connection 2)	
Standards	IRIDIUM
Frequency (MHz)	1616-1627
VSWR	~1.6:1
Efficiency (%)	~68.1
Peak Gain (dBi)	~5.2
Impedance (Ohm)	50
Polarisation	RHCP
Radiation Pattern	Hemispherical



2J6002Ba

2x 2.4-5.0GHz/WiFi/LPWA/BT/ISM

- Key Features**
- ✔ Low Profile
 - ✔ Ground Plane Independent
 - ✔ Customizable Cable and Connector
 - ✔ Certificates: IP67 - Water Resistant

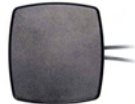

Standard colors.
Other colors upon request.

General specification

Mounting type	Screw mount
Dimensions (mm)	80 x 74 x 14.7
Operating temperature	-40 °C to +85 °C
Thread Length options	8.5mm, 19mm (Default), 30mm
Certificates	IP67

Antenna and electrical specifications

2.4-5.0GHz/WiFi/LPWA/BT/ISM (Connection 1)

Standards	WiFi/Sigfox/LoRa/LPWA/Bluetooth/ BLE/ZigBee/RFID/RPMA/ISM
Frequency (MHz)	2410-2490, 4920-5925
VSWR	~1.3:1, ~1.7:1
Efficiency (%)	~38.4, ~25.6
Peak Gain (dBi)	~3.8, ~2.8
Impedance (Ohm)	50
Polarisation	Linear
Radiation Pattern	Omni-Directional
Max. Input Power (W)	25

Antenna and electrical specifications

2.4-5.0GHz/WiFi/LPWA/BT/ISM (Connection 2)

Standards	WiFi/Sigfox/LoRa/LPWA/Bluetooth/ BLE/ZigBee/RFID/RPMA/ISM
Frequency (MHz)	2410-2490, 4920-5925
VSWR	~1.6:1, ~1.6:1
Efficiency (%)	~36.5, ~27.7
Peak Gain (dBi)	~3.8, ~3.4
Impedance (Ohm)	50
Polarisation	Linear
Radiation Pattern	Omni-Directional
Max. Input Power (W)	25

2J6702Ba

2x 2.4-5.0GHz/WiFi/LPWA/BT/ISM

- Key Features**
- ✔ Low Profile
 - ✔ Ground Plane Dependent
 - ✔ Customizable Cable and Connector
 - ✔ Anti-rotation Mounting
 - ✔ Certificates: IP67 - Water Resistant, IP69 - Hot Water Pressure, IK09 - Impact Resistant



Standard colors.
Other colors upon request.

General specification

Mounting type	Screw mount
Dimensions (mm)	∅ 77.3 x 36.5
Operating temperature	-40 °C to +85 °C
Certificates	IP67, IP69, IK09

Antenna and electrical specifications

2.4-5.0GHz/WiFi/LPWA/BT/ISM (Connection 1)

Standards	WiFi/Sigfox/LoRa/LPWA/Bluetooth/ BLE/ZigBee/RFID/RPMA/ISM
Frequency (MHz)	2410-2490, 4920-5925
VSWR	~1.7:1, ~1.6:1
Efficiency (%)	~40.6, ~21.8
Peak Gain (dBi)	~1.9, ~1.6
Impedance (Ohm)	50
Polarisation	Linear
Radiation Pattern	Omni-Directional
Max. Input Power (W)	25

Antenna and electrical specifications

2.4-5.0GHz/WiFi/LPWA/BT/ISM (Connection 2)

Standards	WiFi/Sigfox/LoRa/LPWA/Bluetooth/ BLE/ZigBee/RFID/RPMA/ISM
Frequency (MHz)	2410-2490, 4920-5925
VSWR	~1.7:1, ~1.6:1
Efficiency (%)	~40.9, ~19.5
Peak Gain (dBi)	~1.8, ~1.3
Impedance (Ohm)	50
Polarisation	Linear
Radiation Pattern	Omni-Directional
Max. Input Power (W)	25



2J6A02Ba

2x 2.4-5.0GHz/WiFi/LPWA/BT/ISM

- Key Features**
- ✔ Ground Plane Dependent
 - ✔ Customizable Cable and Connector
 - ✔ Certificates: IP67 - Water Resistant, IP69 - Hot Water Pressure, IK09 - Impact Resistant
 - ✔ Anti-rotation Mounting



Standard colors.
Other colors upon request.



General specification

Mounting type	Screw mount
Dimensions (mm)	Ø 77.3 × 65.5
Operating temperature	-40 °C to +85 °C
Certificates	IP67, IP69, IK09

Antenna and electrical specifications

2.4-5.0GHz/WiFi/LPWA/BT/ISM (Connection 1)

Standards	WiFi/Sigfox/LoRa/LPWA/Bluetooth/ BLE/ZigBee/RFID/RPMA/ISM
Frequency (MHz)	2410-2490, 4920-5925
VSWR	~1.8:1, ~1.8:1
Efficiency (%)	~50.5, ~48
Peak Gain (dBi)	~2.6, ~4.4
Impedance (Ohm)	50
Polarisation	Linear
Radiation Pattern	Omni-Directional
Max. Input Power (W)	25

Antenna and electrical specifications

2.4-5.0GHz/WiFi/LPWA/BT/ISM (Connection 2)

Standards	WiFi/Sigfox/LoRa/LPWA/Bluetooth/ BLE/ZigBee/RFID/RPMA/ISM
Frequency (MHz)	2410-2490, 4920-5925
VSWR	~2.1:1, ~1.9:1
Efficiency (%)	~44.6, ~45
Peak Gain (dBi)	~2.4, ~4.4
Impedance (Ohm)	50
Polarisation	Linear
Radiation Pattern	Omni-Directional
Max. Input Power (W)	25



2J6041BGFa Active GNSS 2x 4G LTE/FirstNet/LPWA/NB-IoT/3G/2G & GPS/GLONASS/QZSS/Galileo/L1

- Key Features**
- ✔ Low Profile
 - ✔ Ground Plane Independent
 - ✔ Customizable Cable and Connector
 - ✔ Certificates: IP67 - Water Resistant
 - ✔ Pre-Filter GNSS



General specification

Mounting type	Screw mount
Dimensions (mm)	80 × 74 × 14.7
Operating temperature	-40 °C to +85 °C
Thread Length options	8.5mm, 19mm (Default), 30mm
Certificates	IP67

Antenna and electrical specifications

4G LTE/FirstNet/LPWA/NB-IoT/3G/2G (Connection 1)

Standards	4G LTE/FirstNet/LPWA/ CAT-X/CAT-Mx/CAT-NBx/NB-IoT/3G/2G
Frequency (MHz)	698-960, 1710-2170, 2500-2700
VSWR	~2.2:1, ~2.1:1, ~2.1:1
Efficiency (%)	~27, ~28.8, ~25
Peak Gain (dBi)	~-0.1, ~-2.5, ~-2.2
Impedance (Ohm)	50
Polarisation	Linear
Radiation Pattern	Omni-Directional
Max. Input Power (W)	25

Antenna and electrical specifications

4G LTE/FirstNet/LPWA/NB-IoT/3G/2G (Connection 2)

Standards	4G LTE/FirstNet/LPWA/ CAT-X/CAT-Mx/CAT-NBx/NB-IoT/3G/2G
Frequency (MHz)	698-960, 1710-2170, 2500-2700
VSWR	~2.9:1, ~2.2:1, ~1.8:1
Efficiency (%)	~43.8, ~24.9, ~30.8
Peak Gain (dBi)	~2.5, ~2.0, ~3.2
Impedance (Ohm)	50
Polarisation	Linear
Radiation Pattern	Omni-Directional
Max. Input Power (W)	25

Antenna and electrical specifications

GPS/GLONASS/QZSS/Galileo/L1 (Connection 3)

Standards	GPS(L1)/GLONASS(L10F)/QZSS(L1)/Galileo(E1)
Frequency (MHz)	1575.42, 1598-1606
VSWR	<1.4:1
Impedance (Ohm)	50
Radiation Pattern	Hemispherical
Polarisation	RHCP
Active Gain (dB)	28 @ 2.7 V
Voltage (V)	1.5 - 3.6
Current Consumption (mA)	9 Typ
Power Consumption (mW)	24.3 Typ
Saw Filter Type	Pre-Filter
ESD Protection (kV)	2

2J6541BGFa Active GNSS, for EU LTE only 2x 4G LTE/FirstNet/LPWA/NB-IoT/3G/2G & GPS/GLONASS/QZSS/Galileo/L1

- Key Features**
- ✔ Ground Plane Dependent
 - ✔ Customizable Cable and Connector
 - ✔ Certificates: IP67 - Water Resistant, IP69 - Hot Water Pressure, IK09 - Impact Resistant
 - ✔ Anti-rotation Mounting
 - ✔ Pre-Filter GNSS



General specification

Mounting type	Screw mount
Dimensions (mm)	Ø 146 × 31.5
Operating temperature	-40 °C to +85 °C
Certificates	IP67, IP69, IK09

Antenna and electrical specifications

4G LTE/FirstNet/LPWA/NB-IoT/3G/2G (Connection 1)

Standards	4G LTE/FirstNet/LPWA/ CAT-X/CAT-Mx/CAT-NBx/NB-IoT/3G/2G
Frequency (MHz)	791-960, 1710-2170, 2500-2700
VSWR	~2.5:1, ~1.6:1, ~1.9:1
Efficiency (%)	~30.7, ~40.8, ~26.5
Peak Gain (dBi)	~0.5, ~3.3, ~0.9
Impedance (Ohm)	50
Polarisation	Linear
Radiation Pattern	Omni-Directional
Max. Input Power (W)	25

Antenna and electrical specifications

4G LTE/FirstNet/LPWA/NB-IoT/3G/2G (Connection 2)

Standards	4G LTE/FirstNet/LPWA/ CAT-X/CAT-Mx/CAT-NBx/NB-IoT/3G/2G
Frequency (MHz)	791-960, 1710-2170, 2500-2700
VSWR	~2.5:1, ~1.7:1, ~1.9:1
Efficiency (%)	~29.2, ~39, ~25.7
Peak Gain (dBi)	~0.1, ~2.9, ~0.4
Impedance (Ohm)	50
Polarisation	Linear
Radiation Pattern	Omni-Directional
Max. Input Power (W)	25

Antenna and electrical specifications

GPS/GLONASS/QZSS/Galileo/L1 (Connection 3)

Standards	GPS(L1)/GLONASS(L10F)/QZSS(L1)/Galileo(E1)
Frequency (MHz)	1575.42, 1598-1606
VSWR	~1.4:1
Impedance (Ohm)	50
Radiation Pattern	Hemispherical
Polarisation	RHCP
Active Gain (dB)	28 @ 2.7 V
Voltage (V)	1.5 - 3.6
Current Consumption (mA)	9 Typ
Power Consumption (mW)	24.3 Typ
Saw Filter Type	Pre-Filter
ESD Protection (kV)	6



2J6A41BGFa Active GNSS 2x 4G LTE/FirstNet/LPWA/NB-IoT/3G/2G & GPS/GLONASS/QZSS/Galileo/L1

- Key Features**
- ✔ Ground Plane Dependent
 - ✔ Customizable Cable and Connector
 - ✔ Certificates: IP67 - Water Resistant, IP69 - Hot Water Pressure, IK09 - Impact Resistant
 - ✔ Anti-rotation Mounting
 - ✔ Pre-Filter GNSS



White Black
Standard colors.
Other colors upon request.

General specification

Mounting type	Screw mount
Dimensions (mm)	Ø 77.3 × 65.5
Operating temperature	-40 °C to +85 °C
Certificates	IP67, IP69, IK09

Antenna and electrical specifications

4G LTE/FirstNet/LPWA/NB-IoT/3G/2G (Connection 1)

Standards	4G LTE/FirstNet/LPWA/ CAT-X/CAT-Mx/CAT-NBx/NB-IoT/3G/2G
Frequency (MHz)	698-960, 1710-2170, 2500-2700
VSWR	~2.8:1, ~1.7:1, ~1.3:1
Efficiency (%)	~35, ~51, ~49
Peak Gain (dBi)	~-0.8, ~-2.5, ~-3.4
Impedance (Ohm)	50
Polarisation	Linear
Radiation Pattern	Omni-Directional
Max. Input Power (W)	25

Antenna and electrical specifications

4G LTE/FirstNet/LPWA/NB-IoT/3G/2G (Connection 2)

Standards	4G LTE/FirstNet/LPWA/ CAT-X/CAT-Mx/CAT-NBx/NB-IoT/3G/2G
Frequency (MHz)	698-960, 1710-2170, 2500-2700
VSWR	~2.9:1, ~1.4:1, ~1.8:1
Efficiency (%)	~34.2, ~41.1, ~36.7
Peak Gain (dBi)	~-1.0, ~-1.7, ~-3.2
Impedance (Ohm)	50
Polarisation	Linear
Radiation Pattern	Omni-Directional
Max. Input Power (W)	25

Antenna and electrical specifications

GPS/GLONASS/QZSS/Galileo/L1 (Connection 3)

Standards	GPS(L1)/GLONASS(L10F)/QZSS(L1)/Galileo(E1)
Frequency (MHz)	1575.42, 1598-1606
VSWR	<1.4:1
Impedance (Ohm)	50
Radiation Pattern	Hemispherical
Polarisation	RHCP
Active Gain (dB)	28 @ 2.7 V
Voltage (V)	1.5 - 3.6
Current Consumption (mA)	9 Typ
Power Consumption (mW)	24.3 Typ
Saw Filter Type	Pre-Filter
ESD Protection (kV)	2

2J7041BGFa Active GNSS 2x 4G LTE/FirstNet/LPWA/NB-IoT/3G/2G & GPS/GLONASS/QZSS/Galileo/L1

- Key Features**
- ✔ High Performance
 - ✔ Customizable Cable and Connector
 - ✔ Ground Plane Independent
 - ✔ Heavy Duty antenna with Anti-Rotation Mounting
 - ✔ Certificates: IP67 - Water Resistant, IP69 - Hot Water Pressure, IK09 - Impact Resistant
 - ✔ Certified for Railway industry
 - ✔ Pre-Filter GNSS



White Black
Standard colors.
Other colors upon request.

General specification

Mounting type	Screw mount
Dimensions (mm)	Ø 96 × 90
Operating temperature	-40 °C to +85 °C
Certificates	IP67, IP69, IK09, Certified for Railway industry

Antenna and electrical specifications

4G LTE/FirstNet/LPWA/NB-IoT/3G/2G (Connection 1)

Standards	4G LTE/FirstNet/LPWA/ CAT-X/CAT-Mx/CAT-NBx/NB-IoT/3G/2G
Frequency (MHz)	698-960, 1710-2170, 2500-2700
VSWR	~1.9:1, ~1.6:1, ~1.7:1
Efficiency (%)	~57, ~57, ~47
Peak Gain (dBi)	~2.1, ~4.2, ~3.1
Impedance (Ohm)	50
Polarisation	Linear
Radiation Pattern	Omni-Directional
Max. Input Power (W)	25

Antenna and electrical specifications

4G LTE/FirstNet/LPWA/NB-IoT/3G/2G (Connection 2)

Standards	4G LTE/FirstNet/LPWA/ CAT-X/CAT-Mx/CAT-NBx/NB-IoT/3G/2G
Frequency (MHz)	698-960, 1710-2170, 2500-2700
VSWR	~1.9:1, ~1.6:1, ~1.4:1
Efficiency (%)	~63, ~54, ~57
Peak Gain (dBi)	~3.0, ~3.2, ~-4.0
Impedance (Ohm)	50
Polarisation	Linear
Radiation Pattern	Omni-Directional
Max. Input Power (W)	25

Antenna and electrical specifications

GPS/GLONASS/QZSS/Galileo/L1 (Connection 3)

Standards	GPS(L1)/GLONASS(L10F)/QZSS(L1)/Galileo(E1)
Frequency (MHz)	1575.42, 1598-1606
VSWR	<1.4:1
Impedance (Ohm)	50
Radiation Pattern	Hemispherical
Polarisation	RHCP
Active Gain (dB)	28 @ 2.7 V
Voltage (V)	1.5 - 3.6
Current Consumption (mA)	9 Typ
Power Consumption (mW)	24.3 Typ
Saw Filter Type	Pre-Filter
ESD Protection (kV)	6



2J7741BGfA Active GNSS 2x 4G LTE/FirstNet/LPWA/NB-IoT/3G/2G & GPS/GLONASS/QZSS/Galileo/L1

- Key Features**
- High Performance
 - Ground Plane Dependent
 - Customizable Cable and Connector
 - Anti-Rotation Mounting
 - Pre-Filter GNSS
 - Certificates: IP67 - Water Resistant, IP69 - Hot Water Pressure, IK09 - Impact Resistant



General specification

Mounting type	Screw mount
Dimensions (mm)	Ø 60 × 69
Operating temperature	-40 °C to +85 °C
Certificates	IP67, IP69, IK09

Antenna and electrical specifications

4G LTE/FirstNet/LPWA/NB-IoT/3G/2G (Connection 1)

Standards	4G LTE/FirstNet/LPWA/ CAT-X/CAT-Mx/CAT-NBx/NB-IoT/3G/2G
Frequency (MHz)	698-960, 1710-2170, 2500-2700
VSWR	~2.9:1, ~1.4:1, ~1.4:1
Efficiency (%)	~37.8, ~53.3, ~54.9
Peak Gain (dBi)	~-0.8, ~3.6, ~4.1
Impedance (Ohm)	50
Polarisation	Linear
Radiation Pattern	Omni-Directional
Max. Input Power (W)	25

Antenna and electrical specifications

4G LTE/FirstNet/LPWA/NB-IoT/3G/2G (Connection 2)

Standards	4G LTE/FirstNet/LPWA/ CAT-X/CAT-Mx/CAT-NBx/NB-IoT/3G/2G
Frequency (MHz)	698-960, 1710-2170, 2500-2700
VSWR	~2.8:1, ~1.5:1, ~2.1:1
Efficiency (%)	~38.7, ~52.3, ~42.1
Peak Gain (dBi)	~-0.6, ~2.9, ~3.0
Impedance (Ohm)	50
Polarisation	Linear
Radiation Pattern	Omni-Directional
Max. Input Power (W)	25

Antenna and electrical specifications

GPS/GLONASS/QZSS/Galileo/L1 (Connection 3)

Standards	GPS(L1)/GLONASS(L1OF)/QZSS(L1)/Galileo(E1)
Frequency (MHz)	1575.42, 1598-1606
VSWR	<1.4:1
Impedance (Ohm)	50
Radiation Pattern	Hemispherical
Polarisation	RHCP
Active Gain (dB)	28 @ 2.7 V
Voltage (V)	1.5 - 3.6
Current Consumption (mA)	9 Typ
Power Consumption (mW)	24.3 Typ
Saw Filter Type	Pre-Filter
ESD Protection (kV)	2

2J6047Pa 2x 4G LTE/FirstNet/LPWA/NB-IoT/3G/2G & 2.4-5.0GHz/WiFi/LPWA/BT/ISM

- Key Features**
- Low Profile
 - Ground Plane Independent
 - Customizable Cable and Connector
 - Certificates: IP67 - Water Resistant



General specification

Mounting type	Screw mount
Dimensions (mm)	80 × 74 × 14.7
Operating temperature	-40 °C to +85 °C
Thread Length options	8.5mm, 19mm (Default), 30mm
Certificates	IP67

Antenna and electrical specifications

4G LTE/FirstNet/LPWA/NB-IoT/3G/2G (Connection 1)

Standards	4G LTE/FirstNet/LPWA/ CAT-X/CAT-Mx/CAT-NBx/NB-IoT/3G/2G
Frequency (MHz)	698-960, 1710-2170, 2500-2700
VSWR	~2.3:1, ~1.2:1, ~1.7:1
Efficiency (%)	~43.7, ~54.7, ~33.6
Peak Gain (dBi)	~3.2, ~4.3, ~1.9
Impedance (Ohm)	50
Polarisation	Linear
Radiation Pattern	Omni-Directional
Max. Input Power (W)	25

Antenna and electrical specifications

4G LTE/FirstNet/LPWA/NB-IoT/3G/2G (Connection 2)

Standards	4G LTE/FirstNet/LPWA/ CAT-X/CAT-Mx/CAT-NBx/NB-IoT/3G/2G
Frequency (MHz)	698-960, 1710-2170, 2500-2700
VSWR	~2.2:1, ~1.2:1, ~1.7:1
Efficiency (%)	~45.4, ~56.8, ~43.6
Peak Gain (dBi)	~4.1, ~3.5, ~3.0
Impedance (Ohm)	50
Polarisation	Linear
Radiation Pattern	Omni-Directional
Max. Input Power (W)	25

Antenna and electrical specifications

2.4-5.0GHz/WiFi/LPWA/BT/ISM (Connection 3)

Standards	WiFi/Sigfox/LoRa/LPWA/Bluetooth/ BLE/ZigBee/RFID/RFMA/ISM
Frequency (MHz)	2410-2490, 4920-5925
VSWR	~1.3:1, ~1.4:1
Efficiency (%)	~30.6, ~27.6
Peak Gain (dBi)	~7.5, ~3.8
Impedance (Ohm)	50
Polarisation	Linear
Radiation Pattern	Omni-Directional
Max. Input Power (W)	25



2J6050BGF Active GNSS 4G LTE/FirstNet/LPWA/NB-IoT/3G/2G & GPS/GLONASS/QZSS/Galileo/L1 & 2.4-5.0GHz/WiFi/LPWA/BT/ISM

- Key Features** ✓ Low Profile ✓ Ground Plane Independent ✓ Pre-Filter GNSS
✓ Customizable Cable and Connector ✓ Certificates: IP67 - Water Resistant



General specification

Mounting type	Screw mount
Dimensions (mm)	80 × 74 × 14.7
Operating temperature	-40 °C to +85 °C
Thread Length options	8.5mm, 19mm (Default), 30mm
Certificates	IP67

Antenna and electrical specifications

4G LTE/FirstNet/LPWA/NB-IoT/3G/2G (Connection 1)

Standards	4G LTE/FirstNet/LPWA/ CAT-X/CAT-Mx/CAT-NBx/NB-IoT/3G/2G
Frequency (MHz)	698-960, 1710-2170, 2500-2700
VSWR	~2.8:1, ~2.4:1, ~1.4:1
Efficiency (%)	~30.5, ~27.9, ~45.9
Peak Gain (dBi)	~1.4, ~2.9, ~5.2
Impedance (Ohm)	50
Polarisation	Linear
Radiation Pattern	Omni-Directional
Max. Input Power (W)	25

Antenna and electrical specifications

GPS/GLONASS/QZSS/Galileo/L1 (Connection 2)

Standards	GPS(L1)/GLONASS(L10F)/QZSS(L1)/Galileo(E1)
Frequency (MHz)	1575.42, 1598-1606
VSWR	<1.4:1
Impedance (Ohm)	50
Radiation Pattern	Hemispherical
Polarisation	RHCP
Active Gain (dB)	28 @ 2.7 V
Voltage (V)	1.5 - 3.6
Current Consumption (mA)	9 Typ
Power Consumption (mW)	24.3 Typ
Saw Filter Type	Pre-Filter
ESD Protection (kV)	2

Antenna and electrical specifications

2.4-5.0GHz/WiFi/LPWA/BT/ISM (Connection 3)

Standards	WiFi/Sigfox/LoRa/LPWA/Bluetooth/ BLE/ZigBee/RFID/RFMA/ISM
Frequency (MHz)	2410-2490, 4920-5925
VSWR	~1.6:1, ~1.8:1
Efficiency (%)	~35.4, ~26.4
Peak Gain (dBi)	~4.0, ~5.2
Impedance (Ohm)	50
Polarisation	Linear
Radiation Pattern	Omni-Directional
Max. Input Power (W)	25

2J6A50BGF Active GNSS 4G LTE/FirstNet/LPWA/NB-IoT/3G/2G & GPS/GLONASS/QZSS/Galileo/L1 & 2.4-5.0GHz/WiFi/LPWA/BT/ISM

- Key Features** ✓ Ground Plane Dependent ✓ Customizable Cable and Connector
✓ Certificates: IP67 - Water Resistant, IP69 - Hot Water Pressure, IK09 - Impact Resistant
✓ Anti-rotation Mounting ✓ Pre-Filter GNSS



General specification

Mounting type	Screw mount
Dimensions (mm)	∅ 77.3 × 65.5
Operating temperature	-40 °C to +85 °C
Certificates	IP67, IP69, IK09

Antenna and electrical specifications

4G LTE/FirstNet/LPWA/NB-IoT/3G/2G (Connection 1)

Standards	4G LTE/FirstNet/LPWA/ CAT-X/CAT-Mx/CAT-NBx/NB-IoT/3G/2G
Frequency (MHz)	698-960, 1710-2170, 2500-2700
VSWR	~2.1:1, ~1.5:1, ~1.5:1
Efficiency (%)	~52, ~62, ~50
Peak Gain (dBi)	~0.7, ~3.4, ~4.0
Impedance (Ohm)	50
Polarisation	Linear
Radiation Pattern	Omni-Directional
Max. Input Power (W)	25

Antenna and electrical specifications

GPS/GLONASS/QZSS/Galileo/L1 (Connection 2)

Standards	GPS(L1)/GLONASS(L10F)/QZSS(L1)/Galileo(E1)
Frequency (MHz)	1575.42, 1598-1606
VSWR	<1.4:1
Impedance (Ohm)	50
Radiation Pattern	Hemispherical
Polarisation	RHCP
Active Gain (dB)	28 @ 2.7 V
Voltage (V)	1.5 - 3.6
Current Consumption (mA)	9 Typ
Power Consumption (mW)	24.3 Typ
Saw Filter Type	Pre-Filter
ESD Protection (kV)	2

Antenna and electrical specifications

2.4-5.0GHz/WiFi/LPWA/BT/ISM (Connection 3)

Standards	WiFi/Sigfox/LoRa/LPWA/Bluetooth/ BLE/ZigBee/RFID/RFMA/ISM
Frequency (MHz)	2410-2490, 4920-5925
VSWR	~1.2:1, ~1.8:1
Efficiency (%)	~60.5, ~38.4
Peak Gain (dBi)	~5.0, ~3.9
Impedance (Ohm)	50
Polarisation	Linear
Radiation Pattern	Omni-Directional
Max. Input Power (W)	25



2J7750BGF Active GNSS 4G LTE/FirstNet/LPWA/NB-IoT/3G/2G & GPS/GLONASS/QZSS/Galileo/L1 & 2.4-5.0GHz/WiFi/LPWA/BT/ISM

- Key Features**
- ✔ High Performance
 - ✔ Ground Plane Dependent
 - ✔ Customizable Cable and Connector
 - ✔ Anti-Rotation Mounting
 - ✔ Pre-Filter GNSS
 - ✔ Certificates: IP67 - Water Resistant, IP69 - Hot Water Pressure, IK09 - Impact Resistant



General specification

Mounting type	Screw mount
Dimensions (mm)	Ø 60 × 69
Operating temperature	-40 °C to +85 °C
Certificates	IP67, IP69, IK09

Antenna and electrical specifications

4G LTE/FirstNet/LPWA/NB-IoT/3G/2G (Connection 1)

Standards	4G LTE/FirstNet/LPWA/ CAT-X/CAT-Mx/CAT-NBx/NB-IoT/3G/2G
Frequency (MHz)	698-960, 1710-2170, 2500-2700
VSWR	~2.2:1, ~1.4:1, ~1.6:1
Efficiency (%)	~67, ~65.5, ~50
Peak Gain (dBi)	~2.0, ~4.5, ~3.7
Impedance (Ohm)	50
Polarisation	Linear
Radiation Pattern	Omni-Directional
Max. Input Power (W)	25

Antenna and electrical specifications

GPS/GLONASS/QZSS/Galileo/L1 (Connection 2)

Standards	GPS(L1)/GLONASS(L10F)/QZSS(L1)/Galileo(E1)
Frequency (MHz)	1575.42, 1598-1606
VSWR	<1.4:1
Impedance (Ohm)	50
Radiation Pattern	Hemispherical
Polarisation	RHCP
Active Gain (dB)	28 @ 2.7 V
Voltage (V)	1.5 - 3.6
Current Consumption (mA)	9 Typ
Power Consumption (mW)	24.3 Typ
Saw Filter Type	Pre-Filter
ESD Protection (kV)	2

Antenna and electrical specifications

2.4-5.0GHz/WiFi/LPWA/BT/ISM (Connection 3)

Standards	WiFi/Sigfox/LoRa/LPWA/Bluetooth/ BLE/ZigBee/RFID/RFMA/ISM
Frequency (MHz)	2410-2490, 4920-5925
VSWR	~1.5:1, ~2.5:1
Efficiency (%)	~60.1, ~31.4
Peak Gain (dBi)	~4.5, ~2.5
Impedance (Ohm)	50
Polarisation	Linear
Radiation Pattern	Omni-Directional
Max. Input Power (W)	25

2J8750BGF Antenna

Explore NEW
„Shark Fin“

3-in-1
series antenna



4GLTE/FirstNet/LPWA/NB-IoT/Cat-X-Mx-NBx/3G/2G

2.4-5.0GHz/WiFi/Sigfox/LoRa/LPWA/BT/ZigBee/RFID/ISM

GPS/GLONASS/QZSS/Galileo/L1

The Next Generation 3-in-1 Antenna Reaching Global Connectivity With Excellence

The Cellular/LTE, 2.4/5.0 GHz, ISM and GNSS Screw Mount Antenna (2J8750BGF) is a 3-in-1 'Shark Fin', high-performance antenna ideal for powerful global connection on the move. The 2J8750BGF outperforms any competitor by offering 4G, LTE, 2G, 3G, WiFi, Bluetooth-BT, ZigBee, GPS, QZSS, Galileo and GLONASS standards. The 2J8750BGF is highly reliable while maintaining constant global connectivity across a multitude of terrains. This makes it ideal for tracking/mapping devices, automobile navigation, commercial transportation, M2M and worldwide voice/data communications.

The Cellular/LTE (Cable 1) is designed within 4G LTE, 3G and 2G standards. Designed with an omni-directional radiation pattern and operates within 698MHz-960MHz, 1710MHz-2170MHz and 2500MHz-2700MHz frequencies. The 2J8750BGF is tuned and calibrated to improve signal strength and allow for uninterrupted connectivity, better signal quality, and reliability while providing increased long- and short-range cellular data and video bandwidth throughput.

The 2.4/5.0 GHz ISM (Cable 2) Antenna is ideal for WiFi, Bluetooth-BT, ZigBee and ISM standards. The 2J8750BGF WIFI antenna operates within 2410MHz-2490MHz and 4920MHz-5925MHz frequencies. Designed for reliable M2M connection ideal for low power WiFi, Bluetooth-BT, smart home and commercial devices.

The GPS/GLONASS Antenna (Cable 3) is designed for reliable navigational connectivity within GPS, QZSS, Galileo and GLONASS standards. With a hemispherical radiation pattern, the 2J8750BGF navigation antenna operates within 1575.42MHz and 1598MHz-1606MHz frequencies. This high-quality antenna offers access to multiple satellites improving accuracy, redundancy and availability uninterrupted ideal for global automotive navigation/geolocation while moving through busy urban areas where obstructions pose a threat to connectivity and signal degradation.

Installation / Environmental

For external applications, the production material used is PC/ABS UV stable, protecting the antenna from temperatures between -40°C and +85°C. With a shark fin design, anti-rotation mechanism and ground plane independence, this screw mount antenna is easy to install with maximum durability. All three cables on the 2J8750BGF antenna have a SMA-Male standard connector, 300cm standard cable length and are fully customizable by offering additional connector types, cable lengths and cable types. 2J8750BGF is RoHS compliant with complete IP67, IP69 and IK09 certification.



2J8750BGF Active GNSS 4G LTE/FirstNet/LPWA/NB-IoT/3G/2G & GPS/GLONASS/QZSS/Galileo/L1 & 2.4-5.0GHz/WiFi/LPWA/BT/ISM

- Key Features**
- High Performance
 - Ground Plane Dependent
 - Customizable Cable and Connector
 - Anti-Rotation Mounting
 - Pre-Filter GNSS
 - Certificates: IP67 - Water Resistant, IP69 - Hot Water Pressure, IK09 - Impact Resistant



Standard colors.
Other colors upon request.

General specification

Mounting type	Screw mount
Dimensions (mm)	102 × 63 × 63
Operating temperature	-40 °C to +85 °C
Certificates	IP67, IP69, IK09



Antenna and electrical specifications

4G LTE/FirstNet/LPWA/NB-IoT/3G/2G (Connection 1)

Standards	4G LTE/FirstNet/LPWA/ CAT-X/CAT-Mx/CAT-NBx/NB-IoT/3G/2G
Frequency (MHz)	698-960, 1710-2170, 2500-2700
VSWR	~1.9:1, ~1.7:1, ~1.4:1
Efficiency (%)	~52.3, ~40.7, ~46.7
Peak Gain (dBi)	~1.2, ~2.0, ~3.1
Impedance (Ohm)	50
Polarisation	Linear
Radiation Pattern	Omni-Directional
Max. Input Power (W)	25

Antenna and electrical specifications

GPS/GLONASS/QZSS/Galileo/L1 (Connection 2)

Standards	GPS(L1)/GLONASS(L10F)/QZSS(L1)/Galileo(E1)
Frequency (MHz)	1575.42, 1598-1606
VSWR	<1.4:1
Impedance (Ohm)	50
Radiation Pattern	Hemispherical
Polarisation	RHCP
Active Gain (dB)	28 @ 2.7 V
Voltage (V)	1.5 - 3.6
Current Consumption (mA)	9 Typ
Power Consumption (mW)	24.3 Typ
Saw Filter Type	Pre-Filter
ESD Protection (kV)	2

Antenna and electrical specifications

2.4-5.0GHz/WiFi/LPWA/BT/ISM (Connection 3)

Standards	WiFi/Sigfox/LoRa/LPWA/Bluetooth/ BLE/ZigBee/RFID/RFMA/ISM
Frequency (MHz)	2410-2490, 4920-5925
VSWR	~1.2:1, ~1.3:1
Efficiency (%)	~48.8, ~28
Peak Gain (dBi)	~4.1, ~2.5
Impedance (Ohm)	50
Polarisation	Linear
Radiation Pattern	Omni-Directional
Max. Input Power (W)	25

2J6A50BCF Active GNSS 4G LTE/FirstNet/LPWA/NB-IoT/3G/2G & GPS/GLONASS/BEIDOU/QZSS/Galileo/L1 & 2.4-5.0GHz/WiFi/LPWA/BT/ISM

- Key Features**
- Ground Plane Dependent
 - Customizable Cable and Connector
 - Certificates: IP67 - Water Resistant, IP69 - Hot Water Pressure, IK09 - Impact Resistant
 - Anti-rotation Mounting
 - Pre-Filter GNSS



Standard colors.
Other colors upon request.

General specification

Mounting type	Screw mount
Dimensions (mm)	Ø 77.3 × 65.5
Operating temperature	-40 °C to +85 °C
Certificates	IP67, IP69, IK09



Antenna and electrical specifications

4G LTE/FirstNet/LPWA/NB-IoT/3G/2G (Connection 1)

Standards	4G LTE/FirstNet/LPWA/ CAT-X/CAT-Mx/CAT-NBx/NB-IoT/3G/2G
Frequency (MHz)	698-960, 1710-2170, 2500-2700
VSWR	~2.1:1, ~1.5:1, ~1.5:1
Efficiency (%)	~52, ~62, ~50
Peak Gain (dBi)	~0.7, ~3.4, ~4.0
Impedance (Ohm)	50
Polarisation	Linear
Radiation Pattern	Omni-Directional
Max. Input Power (W)	25

Antenna and electrical specifications

GPS/GLONASS/BEIDOU/QZSS/Galileo/L1 (Connection 2)

Standards	GPS(L1)/GLONASS(L10F)/BeiDou(B1)/ QZSS(L1)/Galileo(E1)
Frequency (MHz)	1561.098, 1575.42, 1598-1606
VSWR	<1.4:1
Impedance (Ohm)	50
Radiation Pattern	Hemispherical
Polarisation	RHCP
Active Gain (dB)	28 @ 2.7 V
Voltage (V)	1.5 - 3.6
Current Consumption (mA)	9 Typ
Power Consumption (mW)	24.3 Typ
Saw Filter Type	Pre-Filter
ESD Protection (kV)	2

Antenna and electrical specifications

2.4-5.0GHz/WiFi/LPWA/BT/ISM (Connection 3)

Standards	WiFi/Sigfox/LoRa/LPWA/Bluetooth/ BLE/ZigBee/RFID/RFMA/ISM
Frequency (MHz)	2410-2490, 4920-5925
VSWR	~1.2:1, ~1.8:1
Efficiency (%)	~60.5, ~38.4
Peak Gain (dBi)	~5.0, ~3.9
Impedance (Ohm)	50
Polarisation	Linear
Radiation Pattern	Omni-Directional
Max. Input Power (W)	25

2J6975BGF Antenna



3 in 1 CELLULAR/LTE, GNSS and Iridium certified Antenna

 **iridium®**
certified

4GLTE/FirstNet/LPWA/NB-IoT/Cat-X-Mx-NBx/3G/2G

GPS/GLONASS/QZSS/Galileo/L1

IRIDIUM

The 3-in-1 Iridium certified antenna connecting you to the world with precision

The Cellular/LTE, GNSS and Iridium Screw Mount (2J6975BGF) is a 3-in-1, high-performance antenna that maximizes versatile usability without compromising efficiency. The compact size 2J6975BGF outperforms any competitor by offering 4G, LTE, 2G, 3G, GPS, QZSS, Galileo, GLONASS and Iridium standards. The 2J6975BGF offers reliable, constant global connectivity with the highest precision ideal for tracking/mapping devices, industrial machinery, sea vessels, air/automobile navigation and worldwide voice/data communications.

The Cellular/LTE (Cable 1) is suitable within 4G LTE, 3G and 2G standards. With omni-directional radiation pattern the 2J6975BGF operates within 698MHz-960MHz, 1710MHz-2170MHz and 2600MHz-2700MHz frequencies. Designed to improve signal strength allowing uninterrupted connectivity, better signal quality, and reliability while providing increased data throughput.

The GNSS Ceramic Active Antenna (Cable 2) is designed for reliable navigational connectivity within GPS/ QZSS/ Galileo and GLONASS standards. With hemispherical radiation pattern, the 2J6975BGF operates within 1575.42MHz and 1598MHz-1606MHz frequencies. The GNSS Ceramic Active Antenna offers access to multiple satellites improving accuracy, redundancy and availability at all times.

The Iridium Antenna (Cable 3) is designed for Iridium standards. With hemispherical radiation pattern, the 2J6975BGF operates within 1616MHz-1627MHz frequencies and is IP67 and IP69 Iridium certified. The Iridium antenna offers the most reliable global connectivity on the market including poles, oceans and airways. This antenna is ideal for worldwide voice and data communication from hand-held satellite phones and other transceiver units.

Installation/Environment

For internal and external applications, the production material used is black/white ABS UV stable, protecting the antenna from temperatures between -40°C and +85°C. With anti-rotation mechanism and ground plane independence, this antenna is easy to install with minimal location restrictions. All three cables on the 2J6975BGF antenna have a SMA-Male standard connector and come with 300cm standard cable length. The 2J6975BGF is fully customizable by offering other connector types, cable lengths and cable types. The 2J6975BGF is manufactured with RoHS compliance and complete IP67 and IP69 Iridium certification.



2J6975BGF Active GNSS 4G LTE/FirstNet/LPWA/NB-IoT/3G/2G & GPS/GLONASS/QZSS/Galileo/L1 & IRIDIUM

- Key Features**
- ✔ Ground Plane Independent
 - ✔ Pre-Filter GNSS
 - ✔ Certificates: IP67 - Water Resistant, IP69 - Hot Water Pressure
 - ✔ Customizable Cable and Connector
 - ✔ High Performance
 - ✔ High Efficiency

iridium certified antenna



White Black
Standard colors.
Other colors upon request.

General specification

Mounting type	Screw mount
Dimensions (mm)	80 × 76 × 25.6
Operating temperature	-40 °C to +85 °C
Certificates	IP67, IP69

Antenna and electrical specifications

4G LTE/FirstNet/LPWA/NB-IoT/3G/2G (Connection 1)

Standards	4G LTE/FirstNet/LPWA/ CAT-X/CAT-Mx/CAT-NBx/NB-IoT/3G/2G
Frequency (MHz)	698-960, 1710-2170, 2500-2700
VSWR	~2.1:1, ~2.7:1, ~1.3:1
Efficiency (%)	~45.9, ~50.3, ~64.1
Peak Gain (dBi)	~2.7, ~5.1, ~5.3
Impedance (Ohm)	50
Polarisation	Linear
Radiation Pattern	Omni-Directional
Max. Input Power (W)	25

Antenna and electrical specifications

GPS/GLONASS/QZSS/Galileo/L1 (Connection 2)

Standards	GPS(L1)/GLONASS(L10F)/QZSS(L1)/Galileo(E1)
Frequency (MHz)	1575.42, 1598-1606
VSWR	<1.4:1
Impedance (Ohm)	50
Radiation Pattern	Hemispherical
Polarisation	RHCP
Active Gain (dB)	28 @ 2.7 V
Voltage (V)	1.5 - 3.6
Current Consumption (mA)	9 Typ
Power Consumption (mW)	24.3 Typ
Saw Filter Type	Pre-Filter
ESD Protection (kV)	2

Antenna and electrical specifications

IRIDIUM (Connection 3)

Standards	IRIDIUM
Frequency (MHz)	1616-1627
VSWR	~1.6:1
Efficiency (%)	~68.1
Peak Gain (dBi)	~5.2
Impedance (Ohm)	50
Polarisation	RHCP
Radiation Pattern	Hemispherical

2J6506BGF-2.4 Active GNSS 3G/2G/CELLULAR & GPS/GLONASS/QZSS/Galileo/L1 & 2.4GHz/WiFi/LPWA/BT/ISM

- Key Features**
- ✔ Ground Plane Dependent
 - ✔ Customizable Cable and Connector
 - ✔ Certificates: IP67 - Water Resistant, IP69 - Hot Water Pressure, IK09 - Impact Resistant
 - ✔ Anti-rotation Mounting
 - ✔ Pre-Filter GNSS



White Black
Standard colors.
Other colors upon request.

General specification

Mounting type	Screw mount
Dimensions (mm)	∅ 146 × 31.5
Operating temperature	-40 °C to +85 °C
Certificates	IP67, IP69, IK09

Antenna and electrical specifications

3G/2G/CELLULAR (Connection 1)

Standards	3G/Cellular/HSPA/UMTS/WCDA/ EDGE/EGPRS/GRPS/GSM/CDMA/2G
Frequency (MHz)	824-960, 1710-2170
VSWR	~2.1:1, ~1.7:1
Efficiency (%)	~43, ~37
Peak Gain (dBi)	~1.8, ~2.3
Impedance (Ohm)	50
Polarisation	Linear
Radiation Pattern	Omni-Directional
Max. Input Power (W)	25

Antenna and electrical specifications

GPS/GLONASS/QZSS/Galileo/L1 (Connection 2)

Standards	GPS(L1)/GLONASS(L10F)/QZSS(L1)/Galileo(E1)
Frequency (MHz)	1575.42, 1598-1606
VSWR	<1.4:1
Impedance (Ohm)	50
Radiation Pattern	Hemispherical
Polarisation	RHCP
Active Gain (dB)	28 @ 2.7 V
Voltage (V)	1.5 - 3.6
Current Consumption (mA)	9 Typ
Power Consumption (mW)	24.3 Typ
Saw Filter Type	Pre-Filter
ESD Protection (kV)	6

Antenna and electrical specifications

2.4GHz/WiFi/LPWA/BT/ISM (Connection 3)

Standards	WiFi/Sigfox/LoRa/LPWA/Bluetooth/ BLE/ZigBee/RFID/RFMA/ISM
Frequency (MHz)	2410-2490
VSWR	~1.4:1
Efficiency (%)	~38
Peak Gain (dBi)	~2.5
Impedance (Ohm)	50
Polarisation	Linear
Radiation Pattern	Omni-Directional
Max. Input Power (W)	10



2J8606BGF Active GNSS

3G/2G/CELLULAR & GPS/GLONASS/QZSS/Galileo/L1 & 2.4GHz/WiFi/LPWA/BT/ISM

- Key Features**
- ✓ Ground Plane Dependent
 - ✓ Pre-Filter GNSS
 - ✓ Certificates: IP67 - Water Resistant, IP69 - Hot Water Pressure
 - ✓ Customizable Cable and Connector
 - ✓ Low Profile
 - ✓ Anti-rotation Mounting



Standard colors.
Other colors upon request.

General specification

Mounting type	Screw mount
Dimensions (mm)	99 × 60 × 46
Operating temperature	-40 °C to +85 °C
Certificates	IP67, IP69

Antenna and electrical specifications

3G/2G/CELLULAR (Connection 1)

Standards	3G/Cellular/HSPA/UMTS/WCDA/EDGE/EGPRS/GRPS/GSM/CDMA/2G
Frequency (MHz)	824-960, 1710-2170
VSWR	~3.0:1, ~1.9:1
Efficiency (%)	~11.3, ~20.4
Peak Gain (dBi)	~-5.1, ~0.1
Impedance (Ohm)	50
Polarisation	Linear
Radiation Pattern	Omni-Directional
Max. Input Power (W)	25

Antenna and electrical specifications

GPS/GLONASS/QZSS/Galileo/L1 (Connection 2)

Standards	GPS(L1)/GLONASS(L10F)/QZSS(L1)/Galileo(E1)
Frequency (MHz)	1575.42, 1598-1606
VSWR	<1.2:1
Impedance (Ohm)	50
Radiation Pattern	Hemispherical
Polarisation	RHCP
Active Gain (dB)	23 @ 3V / 24 @ 5V
Voltage (V)	2.7 - 5.5
Current Consumption (mA)	15 - 25
Power Consumption (mW)	40.5 - 137.5
Saw Filter Type	Pre-Filter
ESD Protection (kV)	2

Antenna and electrical specifications

2.4GHz/WiFi/LPWA/BT/ISM (Connection 3)

Standards	WiFi/Sigfox/LoRa/LPWA/Bluetooth/BLE/ZigBee/RFID/RFMA/ISM
Frequency (MHz)	2410-2490
VSWR	~1.5:1
Efficiency (%)	~27.4
Peak Gain (dBi)	~0.4
Impedance (Ohm)	50
Polarisation	Linear
Radiation Pattern	Omni-Directional
Max. Input Power (W)	25

2J8408BGF Active GNSS

3G/2G/CELLULAR & GPS/GLONASS/QZSS/Galileo/L1 & 380-470MHz/LPWA/TETRA/UHF

- Key Features**
- ✓ Ground Plane Dependent
 - ✓ Pre-Filter GNSS
 - ✓ Certificates: IP67 - Water Resistant
 - ✓ Anti-rotation Mounting
 - ✓ Customizable Cable and Connector



Standard colors.
Other colors upon request.

General specification

Mounting type	Screw mount
Dimensions (mm)	59.6 × 153.1 × 172.4
Operating temperature	-40 °C to +85 °C
Certificates	IP67

Antenna and electrical specifications

3G/2G/CELLULAR (Connection 1)

Standards	3G/Cellular/HSPA/UMTS/WCDA/EDGE/EGPRS/GRPS/GSM/CDMA/2G
Frequency (MHz)	824-960, 1710-2170
VSWR	~3.5:1, ~1.8:1
Peak Gain (dBi)	~-13.6, ~-1.5
Impedance (Ohm)	50
Polarisation	Linear
Radiation Pattern	Omni-Directional
Max. Input Power (W)	25

Antenna and electrical specifications

GPS/GLONASS/QZSS/Galileo/L1 (Connection 2)

Standards	GPS(L1)/GLONASS(L10F)/QZSS(L1)/Galileo(E1)
Frequency (MHz)	1575.42, 1598-1606
VSWR	<1.2:1
Impedance (Ohm)	50
Radiation Pattern	Hemispherical
Polarisation	RHCP
Active Gain (dB)	23 @ 3V / 24 @ 5V
Voltage (V)	2.7 - 5.5
Current Consumption (mA)	15 - 25
Power Consumption (mW)	40.5 - 137.5
Saw Filter Type	Pre-Filter
ESD Protection (kV)	2

Antenna and electrical specifications

380-470MHz/LPWA/TETRA/UHF (Connection 3)

Standards	TETRA/UHF/PMR/LMR
Frequency (MHz)	380-470
VSWR	~1.3:1
Efficiency (%)	~53.2
Peak Gain (dBi)	~2.0
Impedance (Ohm)	50
Polarisation	Linear
Radiation Pattern	Omni-Directional
Max. Input Power (W)	25



2J6552BGF Active GNSS 3G/2G/CELLULAR & GPS/GLONASS/QZSS/Galileo/L1 & IRIDIUM

- Key Features**
- ✔ Ground Plane Dependent
 - ✔ Customizable Cable and Connector
 - ✔ Certificates: IP67 - Water Resistant, IP69 - Hot Water Pressure, IK09 - Impact Resistant
 - ✔ Anti-rotation Mounting
 - ✔ Pre-Filter GNSS



Standard colors.
Other colors upon request.

General specification

Mounting type	Screw mount
Dimensions (mm)	Ø 146 × 31.5
Operating temperature	-40 °C to +85 °C
Certificates	IP67, IP69, IK09

Antenna and electrical specifications 3G/2G/CELLULAR (Connection 1)

Standards	3G/Cellular/HSPA/UMTS/WCDA/ EDGE/EGPRS/GRPS/GSM/CDMA/2G
Frequency (MHz)	824-960, 1710-2170
VSWR	~2.1:1, ~1.7:1
Efficiency (%)	~43, ~37
Peak Gain (dBi)	~1.8, ~2.3
Impedance (Ohm)	50
Polarisation	Linear
Radiation Pattern	Omni-Directional
Max. Input Power (W)	25

Antenna and electrical specifications GPS/GLONASS/QZSS/Galileo/L1 (Connection 2)

Standards	GPS(L1)/GLONASS(L10F)/QZSS(L1)/Galileo(E1)
Frequency (MHz)	1575.42, 1598-1606
VSWR	<1.4:1
Impedance (Ohm)	50
Radiation Pattern	Hemispherical
Polarisation	RHCP
Active Gain (dB)	28 @ 2.7 V
Voltage (V)	1.5 - 3.6
Current Consumption (mA)	9 Typ
Power Consumption (mW)	24.3 Typ
Saw Filter Type	Pre-Filter
ESD Protection (kV)	6

Antenna and electrical specifications IRIDIUM (Connection 3)

Standards	IRIDIUM
Frequency (MHz)	1616-1627
VSWR	~1.2:1
Efficiency (%)	~76
Peak Gain (dBi)	~4.5
Impedance (Ohm)	50
Polarisation	Linear
Radiation Pattern	Omni-Directional
Max. Input Power (W)	25

2J8579BGF Active GNSS 3G/2G/CELLULAR & GPS/GLONASS/QZSS/Galileo/L1 & AM/FM

- Key Features**
- ✔ Ground Plane Dependent
 - ✔ Customizable Cable and Connector
 - ✔ Certificates: IP67 - Water Resistant, IP69 - Hot Water Pressure, IK09 - Impact Resistant
 - ✔ Anti-rotation Mounting
 - ✔ Pre-Filter GNSS



Standard colors.
Other colors upon request.

General specification

Mounting type	Screw mount
Dimensions (mm)	365.5 × 99 × 60
Operating temperature	-40 °C to +85 °C
Certificates	IP67, IP69, IK09

Antenna and electrical specifications 3G/2G/CELLULAR (Connection 1)

Standards	3G/Cellular/HSPA/UMTS/WCDA/ EDGE/EGPRS/GRPS/GSM/CDMA/2G
Frequency (MHz)	824-960, 1710-2170
VSWR	~2.1:1, ~2.1:1
Efficiency (%)	~30.4, ~7.7
Peak Gain (dBi)	~-0.8, ~-6.4
Impedance (Ohm)	50
Polarisation	Linear
Radiation Pattern	Omni-Directional
Max. Input Power (W)	25

Antenna and electrical specifications GPS/GLONASS/QZSS/Galileo/L1 (Connection 2)

Standards	GPS(L1)/GLONASS(L10F)/QZSS(L1)/Galileo(E1)
Frequency (MHz)	1575.42, 1598-1606
Impedance (Ohm)	50
Polarisation	RHCP
Radiation Pattern	Hemispherical
Active Gain (dB)	28 @ 2.7 V
Voltage (V)	1.5 - 3.6
Current Consumption (mA)	9 Typ
Power Consumption (mW)	24.3 Typ
Saw Filter Type	Pre-Filter
ESD Protection (kV)	6

Antenna and electrical specifications AM/FM (Connection 3)

Standards	AM/FM
Frequency (MHz)	0.53-1.70, 88-108
Impedance (Ohm)	75
Polarisation	Linear
Radiation Pattern	Omni-Directional
Gain (dB)	5-10
Voltage Supply (V)	12-15



2J8311BGF Active GNSS 3G/2G/CELLULAR & GPS/GLONASS/QZSS/Galileo/L1 & FM

- Key Features**
- ✔ Ground Plane Dependent
 - ✔ Anti-rotation Mounting
 - ✔ Customizable Cable and Connector
 - ✔ Certificates: IP67 - Water Resistant
 - ✔ Pre-Filter GNSS



General specification

Mounting type	Screw mount
Dimensions (mm)	60 × 143 × 137
Operating temperature	-40 °C to +85 °C
Certificates	IP67

Antenna and electrical specifications 3G/2G/CELLULAR (Connection 1)

Standards	3G/Cellular/HSPA/UMTS/WCDA/ EDGE/EGPRS/GRPS/GSM/CDMA/2G
Frequency (MHz)	824-960, 1710-2170
VSWR	~2.8:1, ~1.8:1
Efficiency (%)	~11.8, ~13.9
Peak Gain (dBi)	~-4.9, ~-4.6
Impedance (Ohm)	50
Polarisation	Linear
Radiation Pattern	Omni-Directional
Max. Input Power (W)	100

Antenna and electrical specifications GPS/GLONASS/QZSS/Galileo/L1 (Connection 2)

Standards	GPS(L1)/GLONASS(L10F)/QZSS(L1)/Galileo(E1)
Frequency (MHz)	1575.42, 1598-1606
VSWR	<1.2:1
Impedance (Ohm)	50
Radiation Pattern	Hemispherical
Polarisation	RHCP
Active Gain (dB)	23 @ 3V / 24 @ 5V
Voltage (V)	2.7 - 5.5
Current Consumption (mA)	15 - 25
Power Consumption (mW)	40.5 - 137.5
Saw Filter Type	Pre-Filter
ESD Protection (kV)	2

Antenna and electrical specifications FM (Connection 3)

Standards	FM
Frequency (MHz)	88-108
VSWR	~2.2:1
Impedance (Ohm)	75
Polarisation	Linear
Radiation Pattern	Hemispherical
Active Gain (dB)	5 - 10
Voltage (V)	12 - 15

2J6581BGF-433 Active GNSS GPS/GLONASS/QZSS/Galileo/L1 & 2.4GHz/WiFi/LPWA/BT/ISM & 433MHz/LPWA/RFID/ZigBee/ISM

- Key Features**
- ✔ Ground Plane Dependent
 - ✔ Customizable Cable and Connector
 - ✔ Certificates: IP67 - Water Resistant, IP69 - Hot Water Pressure, IK09 - Impact Resistant
 - ✔ Anti-rotation Mounting
 - ✔ Pre-Filter GNSS



General specification

Mounting type	Screw mount
Dimensions (mm)	∅ 146 × 31.5
Operating temperature	-40 °C to +85 °C
Certificates	IP67, IP69, IK09

Antenna and electrical specifications GPS/GLONASS/QZSS/Galileo/L1 (Connection 1)

Standards	GPS(L1)/GLONASS(L10F)/QZSS(L1)/Galileo(E1)
Frequency (MHz)	1575.42, 1598-1606
Impedance (Ohm)	50
Radiation Pattern	RHCP
Polarisation	Hemispherical
Active Gain (dB)	28 @ 2.7 V
Voltage (V)	1.5 - 3.6
Current Consumption (mA)	9 Typ
Power Consumption (mW)	24.3 Typ
Saw Filter Type	Pre-Filter
ESD Protection (kV)	6

Antenna and electrical specifications 2.4GHz/WiFi/LPWA/BT/ISM (Connection 3)

Standards	WiFi/Sigfox/LoRa/LPWA/Bluetooth/ BLE/ZigBee/RFID/RFMA/ISM
Frequency (MHz)	2410-2490
VSWR	~1.4:1
Efficiency (%)	~32.8
Peak Gain (dBi)	~1.2
Impedance (Ohm)	50
Polarisation	Linear
Radiation Pattern	Omni-Directional
Max. Input Power (W)	25

Antenna and electrical specifications 433MHz/LPWA/RFID/ZigBee/ISM (Connection 3)

Standards	Sigfox/LoRa/RFID/LPWA/ISM/UHF
Frequency (MHz)	433-435
VSWR	~1.1:1
Efficiency (%)	~60.6
Peak Gain (dBi)	~2.5
Impedance (Ohm)	50
Polarisation	Linear
Radiation Pattern	Omni-Directional
Max. Input Power (W)	25



2J7183Bc 5G Antenna 4x 5GNR/4GLTE/FirstNet/CBRS/LPWA/3G/2G

- Key Features**
- ✔ High Performance
 - ✔ Customizable Cable and Connector
 - ✔ Ground Plane Independent
 - ✔ Heavy Duty antenna with Anti-Rotation Mounting
 - ✔ Certificates: IP67 - Water Resistant, IP69 - Hot Water Pressure, IK09 - Impact Resistant



General specification

Mounting type	Screw mount
Dimensions (mm)	Ø 96 x 130
Operating temperature	-40 °C to +85 °C
Certificates	IP67, IP69, IK09

Antenna and electrical specifications

5GNR/4GLTE/FirstNet/CBRS/LPWA/3G/2G (Connection 1)

Standards	5GNR/4GLTE/FirstNet/CBRS/LPWA/ CAT-X/CAT-Mx/CAT-NBx/NB-IoT/3G/2G
Frequency (MHz)	617-960, 1427-2690, 3300-5000, 5150-5925
Bands	see 5G Bands list on page 17
VSWR	~3.7:1, ~2.0:1, ~1.5:1, ~1.6:1
Efficiency (%)	~31.0, ~41.6, ~41.6, ~36.9
Peak Gain (dBi)	~1.3, ~3.4, ~4.7, ~4.0
Impedance (Ohm)	50
Polarisation	Linear
Radiation Pattern	Omni-Directional
Max. Input Power (W)	35

Antenna and electrical specifications

5GNR/4GLTE/FirstNet/CBRS/LPWA/3G/2G (Connection 2)

Standards	5GNR/4GLTE/FirstNet/CBRS/LPWA/ CAT-X/CAT-Mx/CAT-NBx/NB-IoT/3G/2G
Frequency (MHz)	617-960, 1427-2690, 3300-5000, 5150-5925
Bands	see 5G Bands list on page 17
VSWR	~3.7:1, ~1.9:1, ~1.5:1, ~1.5:1
Efficiency (%)	~31.2, ~41.4, ~42.4, ~33.1
Peak Gain (dBi)	~1.2, ~3.6, ~4.6, ~3.2
Impedance (Ohm)	50
Polarisation	Linear
Radiation Pattern	Omni-Directional
Max. Input Power (W)	35

Antenna and electrical specifications

5GNR/4GLTE/FirstNet/CBRS/LPWA/3G/2G (Connection 3)

Standards	5GNR/4GLTE/FirstNet/CBRS/LPWA/ CAT-X/CAT-Mx/CAT-NBx/NB-IoT/3G/2G
Frequency (MHz)	617-960, 1427-2690, 3300-5000, 5150-5925
Bands	see 5G Bands list on page 17
VSWR	~3.7:1, ~1.8:1, ~1.4:1, ~1.8:1
Efficiency (%)	~31.5, ~41.6, ~40.3, ~38.5
Peak Gain (dBi)	~1.3, ~3.8, ~4.5, ~4.6
Impedance (Ohm)	50
Polarisation	Linear
Radiation Pattern	Omni-Directional
Max. Input Power (W)	35

Antenna and electrical specifications

5GNR/4GLTE/FirstNet/CBRS/LPWA/3G/2G (Connection 4)

Standards	5GNR/4GLTE/FirstNet/CBRS/LPWA/ CAT-X/CAT-Mx/CAT-NBx/NB-IoT/3G/2G
Frequency (MHz)	617-960, 1427-2690, 3300-5000, 5150-5925
Bands	see 5G Bands list on page 17
VSWR	~3.5:1, ~1.8:1, ~1.5:1, ~1.5:1
Efficiency (%)	~31.2, ~41.8, ~42.5, ~35.0
Peak Gain (dBi)	~1.6, ~3.4, ~4.6, ~3.9
Impedance (Ohm)	50
Polarisation	Linear
Radiation Pattern	Omni-Directional
Max. Input Power (W)	35



2J7024Bc

4x 4GLTE/FirstNet/LPWA/NB-IoT/3G/2G

- Key Features**
- ✔ High Performance
 - ✔ Customizable Cable and Connector
 - ✔ Ground Plane Independent
 - ✔ Heavy Duty antenna with Anti-Rotation Mounting
 - ✔ Certificates: IP67 - Water Resistant, IP69 - Hot Water Pressure, IK09 - Impact Resistant
 - ✔ Certified for Railway industry



General specification

Mounting type	Screw mount
Dimensions (mm)	Ø 96 × 90
Operating temperature	-40 °C to +85 °C
Certificates	IP67, IP69, IK09, Certified for Railway industry

Antenna and electrical specifications

4GLTE/FirstNet/LPWA/NB-IoT/3G/2G (Connection 1)

Standards	4GLTE/FirstNet/LPWA/ CAT-X/CAT-Mx/CAT-NBx/NB-IoT/3G/2G
Frequency (MHz)	698-960, 1710-2170, 2500-2700
VSWR	~2.9:1, ~1.9:1, ~1.3:1
Efficiency (%)	~36, ~41, ~53
Peak Gain (dBi)	~-0.2, ~3.8, ~6.0
Impedance (Ohm)	50
Polarisation	Linear
Radiation Pattern	Omni-Directional
Max. Input Power (W)	25

Antenna and electrical specifications

4GLTE/FirstNet/LPWA/NB-IoT/3G/2G (Connection 2)

Standards	4GLTE/FirstNet/LPWA/ CAT-X/CAT-Mx/CAT-NBx/NB-IoT/3G/2G
Frequency (MHz)	698-960, 1710-2170, 2500-2700
VSWR	~2.8:1, ~2.1:1, ~1.4:1
Efficiency (%)	~35, ~42, ~53
Peak Gain (dBi)	~-0.1, ~3.2, ~5.6
Impedance (Ohm)	50
Polarisation	Linear
Radiation Pattern	Omni-Directional
Max. Input Power (W)	25

Antenna and electrical specifications

4GLTE/FirstNet/LPWA/NB-IoT/3G/2G (Connection 3)

Standards	4GLTE/FirstNet/LPWA/ CAT-X/CAT-Mx/CAT-NBx/NB-IoT/3G/2G
Frequency (MHz)	698-960, 1710-2170, 2500-2700
VSWR	~2.9:1, ~2.0:1, ~1.4:1
Efficiency (%)	~35, ~40, ~53
Peak Gain (dBi)	~-0.5, ~3.1, ~5.0
Impedance (Ohm)	50
Polarisation	Linear
Radiation Pattern	Omni-Directional
Max. Input Power (W)	25

Antenna and electrical specifications

4GLTE/FirstNet/LPWA/NB-IoT/3G/2G (Connection 4)

Standards	4GLTE/FirstNet/LPWA/ CAT-X/CAT-Mx/CAT-NBx/NB-IoT/3G/2G
Frequency (MHz)	698-960, 1710-2170, 2500-2700
VSWR	~2.8:1, ~2.1:1, ~1.4:1
Efficiency (%)	~36, ~42, ~54
Peak Gain (dBi)	~-0.7, ~3.0, ~4.8
Impedance (Ohm)	50
Polarisation	Linear
Radiation Pattern	Omni-Directional
Max. Input Power (W)	25



2J6550BGFB-2.4 Active GNSS, for EU LTE only

2x 4GLTE/FirstNet/LPWA/NB-IoT/3G/2G & GPS/GLONASS/QZSS/Galileo/L1 & 2.4GHz/WiFi/LPWA/BT/ISM

- Key Features**
- ✔ Ground Plane Dependent
 - ✔ Customizable Cable and Connector
 - ✔ Certificates: IP67 - Water Resistant, IP69 - Hot Water Pressure, IK09 - Impact Resistant
 - ✔ Anti-rotation Mounting
 - ✔ Pre-Filter GNSS



White Black
Standard colors.
Other colors upon request.



Antenna and electrical specifications

GPS/GLONASS/QZSS/Galileo/L1 (Connection 3)

Standards	GPS(L1)/GLONASS(L10F)/QZSS(L1)/Galileo(E1)
Frequency (MHz)	1575.42, 1598-1606
VSWR	<1.4:1
Impedance (Ohm)	50
Radiation Pattern	Hemispherical
Polarisation	RHCP
Active Gain (dB)	28 @ 2.7 V
Voltage (V)	1.5 - 3.6
Current Consumption (mA)	9 Typ
Power Consumption (mW)	24.3 Typ
Saw Filter Type	Pre-Filter
ESD Protection (kV)	6

General specification

Mounting type	Screw mount
Dimensions (mm)	Ø 146 x 31.5
Operating temperature	-40 °C to +85 °C
Certificates	IP67, IP69, IK09

Antenna and electrical specifications

4GLTE/FirstNet/LPWA/NB-IoT/3G/2G (Connection 1)

Standards	4GLTE/FirstNet/LPWA/ CAT-X/CAT-Mx/CAT-NBx/NB-IoT/3G/2G
Frequency (MHz)	791-960, 1710-2170, 2500-2700
VSWR	~2.1:1, ~1.4:1, ~1.6:1
Efficiency (%)	~27.5, ~30.7, ~20
Peak Gain (dBi)	~0.1, ~2.1, ~-0.8
Impedance (Ohm)	50
Polarisation	Linear
Radiation Pattern	Omni-Directional
Max. Input Power (W)	25

Antenna and electrical specifications

4GLTE/FirstNet/LPWA/NB-IoT/3G/2G (Connection 2)

Standards	4GLTE/FirstNet/LPWA/ CAT-X/CAT-Mx/CAT-NBx/NB-IoT/3G/2G
Frequency (MHz)	791-960, 1710-2170, 2500-2700
VSWR	~2.1:1, ~1.5:1, ~1.6:1
Efficiency (%)	~25.6, ~30.4, ~19.1
Peak Gain (dBi)	~-0.1, ~1.5, ~-0.7
Impedance (Ohm)	50
Polarisation	Linear
Radiation Pattern	Omni-Directional
Max. Input Power (W)	25

Antenna and electrical specifications

2.4GHz/WiFi/LPWA/BT/ISM (Connection 4)

Standards	WiFi/Sigfox/LoRa/LPWA/Bluetooth/ BLE/ZigBee/RFID/RFMA/ISM
Frequency (MHz)	2410-2490
VSWR	~1.3:1
Efficiency (%)	~26.8
Peak Gain (dBi)	~1.6
Impedance (Ohm)	50
Polarisation	Linear
Radiation Pattern	Omni-Directional
Max. Input Power (W)	25



2J9547a-B01

2x 4GLTE/FirstNet/LPWA/NB-IoT/3G/2G &
2x 2.4-5.0GHz/WiFi/LPWA/BT/ISM

- Key Features**
- ✔ High Performance
 - ✔ High Efficiency
 - ✔ Ground Plane Independent
 - ✔ Customizable Cable and Connector
 - ✔ Certificates: IP69 - Hot Water Pressure



Standard colors.
Other colors upon request.



General specification

Mounting type	Screw mount
Dimensions (mm)	280 × 280 × 150
Operating temperature	-40 °C to +85 °C
Certificates	IP69

Antenna and electrical specifications

4GLTE/FirstNet/LPWA/NB-IoT/3G/2G (Connection 1)

Standards	4GLTE/FirstNet/LPWA/ CAT-X/CAT-Mx/CAT-NBx/NB-IoT/3G/2G
Frequency (MHz)	698-960, 1710-2170, 2500-2700
VSWR	~1.7:1, ~1.3:1, ~1.3:1
Efficiency (%)	~72, ~71, ~72
Peak Gain (dBi)	~3.5, ~4.6, ~3.9
Impedance (Ohm)	50
Polarisation	Linear
Radiation Pattern	Omni-Directional
Max. Input Power (W)	25

Antenna and electrical specifications

4GLTE/FirstNet/LPWA/NB-IoT/3G/2G (Connection 2)

Standards	4GLTE/FirstNet/LPWA/ CAT-X/CAT-Mx/CAT-NBx/NB-IoT/3G/2G
Frequency (MHz)	698-960, 1710-2170, 2500-2700
VSWR	~1.7:1, ~1.3:1, ~1.2:1
Efficiency (%)	~74, ~72, ~70
Peak Gain (dBi)	~3.8, ~5.8, ~4.0
Impedance (Ohm)	50
Polarisation	Linear
Radiation Pattern	Omni-Directional
Max. Input Power (W)	25

Antenna and electrical specifications

2.4-5.0GHz/WiFi/LPWA/BT/ISM (Connection 3)

Standards	WiFi/Sigfox/LoRa/LPWA/Bluetooth/ BLE/ZigBee/RFID/RFMA/ISM
Frequency (MHz)	2410-2490, 4920-5925
VSWR	~1.8:1, ~2.2:1
Efficiency (%)	~48, ~44
Peak Gain (dBi)	~2.9, ~2.7
Impedance (Ohm)	50
Polarisation	Linear
Radiation Pattern	Omni-Directional
Max. Input Power (W)	25

Antenna and electrical specifications

2.4-5.0GHz/WiFi/LPWA/BT/ISM (Connection 4)

Standards	WiFi/Sigfox/LoRa/LPWA/Bluetooth/ BLE/ZigBee/RFID/RFMA/ISM
Frequency (MHz)	2410-2490, 4920-5925
VSWR	~2.0:1, ~2.2:1
Efficiency (%)	~75, ~50
Peak Gain (dBi)	~5.2, ~3.3
Impedance (Ohm)	50
Polarisation	Linear
Radiation Pattern	Omni-Directional
Max. Input Power (W)	25



2J6551BGF Active GNSS 3G/2G/CELLULAR & GPS/GLONASS/QZSS/Galileo/L1 & 2.4GHz/WiFi/LPWA/BT/ISM & IRIDIUM

- Key Features**
- ✔ Ground Plane Dependent
 - ✔ Customizable Cable and Connector
 - ✔ Certificates: IP67 - Water Resistant, IP69 - Hot Water Pressure, IK09 - Impact Resistant
 - ✔ Anti-rotation Mounting
 - ✔ Pre-Filter GNSS



White Black
Standard colors.
Other colors upon request.



General specification

Mounting type	Screw mount
Dimensions (mm)	Ø 146 × 31.5
Operating temperature	-40 °C to +85 °C
Certificates	IP67, IP69, IK09

Antenna and electrical specifications

3G/2G/CELLULAR (Connection 1)

Standards	3G/Cellular/HSPA/UMTS/WCDMA/EDGE/EGPRS/GRPS/GSM/CDMA/2G
Frequency (MHz)	824-960, 1710-2170
VSWR	~2.1:1, ~1.7:1
Efficiency (%)	~43, ~37
Peak Gain (dBi)	~1.8, ~2.3
Impedance (Ohm)	50
Polarisation	Linear
Radiation Pattern	Omni-Directional
Max. Input Power (W)	25

Antenna and electrical specifications

GPS/GLONASS/QZSS/Galileo/L1 (Connection 2)

Standards	GPS(L1)/GLONASS(L1OF)/QZSS(L1)/Galileo(E1)
Frequency (MHz)	1575.42, 1598-1606
VSWR	<1.4:1
Impedance (Ohm)	50
Radiation Pattern	Hemispherical
Polarisation	RHCP
Active Gain (dB)	28 @ 2.7 V
Voltage (V)	1.5 - 3.6
Current Consumption (mA)	9 Typ
Power Consumption (mW)	24.3 Typ
Saw Filter Type	Pre-Filter
ESD Protection (kV)	6

Antenna and electrical specifications

2.4GHz/WiFi/LPWA/BT/ISM (Connection 3)

Standards	WiFi/Sigfox/LoRa/LPWA/Bluetooth/ BLE/ZigBee/RFID/RFMA/ISM
Frequency (MHz)	2410-2490
VSWR	~1.4:1
Efficiency (%)	~38
Peak Gain (dBi)	~2.5
Impedance (Ohm)	50
Polarisation	Linear
Radiation Pattern	Omni-Directional
Max. Input Power (W)	10

Antenna and electrical specifications

IRIDIUM (Connection 4)

Standards	IRIDIUM
Frequency (MHz)	1616-1627
VSWR	~1.2:1
Efficiency (%)	~76
Peak Gain (dBi)	~4.5
Impedance (Ohm)	50
Polarisation	Linear
Radiation Pattern	Omni-Directional
Max. Input Power (W)	25



2J8517BGF Active GNSS 3G/2G/CELLULAR & GPS/GLONASS/QZSS/Galileo/L1 & 2.4-5.0GHz/WiFi/LPWA/BT/ISM & AM/FM

- Key Features**
- ✔ Ground Plane Dependent
 - ✔ Customizable Cable and Connector
 - ✔ Certificates: IP67 - Water Resistant, IP69 - Hot Water Pressure, IK09 - Impact Resistant
 - ✔ Anti-rotation Mounting
 - ✔ Pre-Filter GNSS



General specification

Mounting type	Screw mount
Dimensions (mm)	365.5 × 99 × 60
Operating temperature	-40 °C to +85 °C
Certificates	IP67, IP69, IK09

Antenna and electrical specifications

3G/2G/CELLULAR (Connection 1)

Standards	3G/Cellular/HSPA/UMTS/WCDA/EDGE/EGPRS/GRPS/GSM/CDMA/2G
Frequency (MHz)	824-960, 1710-2170
VSWR	~2.1:1, ~2.1:1
Efficiency (%)	~29.6, ~7.5
Peak Gain (dBi)	~-1.2, ~-6.4
Impedance (Ohm)	50
Polarisation	Linear
Radiation Pattern	Omni-Directional
Max. Input Power (W)	25

Antenna and electrical specifications

GPS/GLONASS/QZSS/Galileo/L1 (Connection 2)

Standards	GPS(L1)/GLONASS(L10F)/QZSS(L1)/Galileo(E1)
Frequency (MHz)	1575.42, 1598-1606
VSWR	<1.4:1
Impedance (Ohm)	50
Radiation Pattern	Hemispherical
Polarisation	RHCP
Active Gain (dB)	28 @ 2.7 V
Voltage (V)	1.5 - 3.6
Current Consumption (mA)	9 Typ
Power Consumption (mW)	24.3 Typ
Saw Filter Type	Pre-Filter
ESD Protection (kV)	6

Antenna and electrical specifications

2.4-5.0GHz/WiFi/LPWA/BT/ISM (Connection 3)

Standards	WiFi/Sigfox/LoRa/LPWA/Bluetooth/ BLE/ZigBee/RFID/RFMA/ISM
Frequency (MHz)	2410-2490, 4920-5925
VSWR	~1.5:1, ~1.2:1
Efficiency (%)	~19.4, ~16.4
Peak Gain (dBi)	~-1.3, ~-1.4
Impedance (Ohm)	50
Polarisation	Linear
Radiation Pattern	Omni-Directional
Max. Input Power (W)	25

Antenna and electrical specifications

AM/FM (Connection 4)

Standards	AM/FM
Frequency (MHz)	0.53-1.70, 88-108
Impedance (Ohm)	75
Polarisation	Linear
Radiation Pattern	Omni-Directional
Gain (dB)	5-10
Voltage Supply (V)	12-15



2J7002Bc

4x 2.4-5.0GHz/WiFi/LPWA/BT/ISM

- Key Features**
- ✔ High Performance
 - ✔ Customizable Cable and Connector
 - ✔ Ground Plane Independent
 - ✔ Heavy Duty antenna with Anti-Rotation Mounting
 - ✔ Certificates: IP67 - Water Resistant, IP69 - Hot Water Pressure, IK09 - Impact Resistant
 - ✔ Certified for Railway industry



General specification

Mounting type	Screw mount
Dimensions (mm)	Ø 96 × 90
Operating temperature	-40 °C to +85 °C
Certificates	IP67, IP69, IK09, Certified for Railway industry

Antenna and electrical specifications

2.4-5.0GHz/WiFi/LPWA/BT/ISM (Connection 3)

Standards	WiFi/Sigfox/LoRa/LPWA/Bluetooth/ BLE/ZigBee/RFID/RFMA/ISM
Frequency (MHz)	2410-2490, 4920-5925
VSWR	~1.9:1, ~1.6:1
Efficiency (%)	~58, ~64
Peak Gain (dBi)	~5.6, ~5.5
Impedance (Ohm)	50
Polarisation	Linear
Radiation Pattern	Omni-Directional
Max. Input Power (W)	25

Antenna and electrical specifications

2.4-5.0GHz/WiFi/LPWA/BT/ISM (Connection 3)

Standards	WiFi/Sigfox/LoRa/LPWA/Bluetooth/ BLE/ZigBee/RFID/RFMA/ISM
Frequency (MHz)	2410-2490, 4920-5925
VSWR	~1.6:1, ~1.5:1
Efficiency (%)	~51, ~55
Peak Gain (dBi)	~3.9, ~4.1
Impedance (Ohm)	50
Polarisation	Linear
Radiation Pattern	Omni-Directional
Max. Input Power (W)	25

Antenna and electrical specifications

2.4-5.0GHz/WiFi/LPWA/BT/ISM (Connection 3)

Standards	WiFi/Sigfox/LoRa/LPWA/Bluetooth/ BLE/ZigBee/RFID/RFMA/ISM
Frequency (MHz)	2410-2490, 4920-5925
VSWR	~2.1:1, ~1.6:1
Efficiency (%)	~57, ~59
Peak Gain (dBi)	~5.5, ~4.4
Impedance (Ohm)	50
Polarisation	Linear
Radiation Pattern	Omni-Directional
Max. Input Power (W)	25

Antenna and electrical specifications

2.4-5.0GHz/WiFi/LPWA/BT/ISM (Connection 3)

Standards	WiFi/Sigfox/LoRa/LPWA/Bluetooth/ BLE/ZigBee/RFID/RFMA/ISM
Frequency (MHz)	2410-2490, 4920-5925
VSWR	~1.8:1, ~1.5:1
Efficiency (%)	~52, ~53
Peak Gain (dBi)	~3.4, ~3.1
Impedance (Ohm)	50
Polarisation	Linear
Radiation Pattern	Omni-Directional
Max. Input Power (W)	25



2J7184BGFc 5G Antenna, Active GNSS 4x 5G NR/4G LTE/FirstNet/CBRS/LPWA/3G/2G & GPS/GLONASS/QZSS/Galileo/L1

- Key Features**
- ✔ High Performance
 - ✔ Customizable Cable and Connector
 - ✔ Ground Plane Independent
 - ✔ Heavy Duty antenna with Anti-Rotation Mounting
 - ✔ Certificates: IP67 - Water Resistant, IP69 - Hot Water Pressure, IK09 - Impact Resistant
 - ✔ Pre-Filter GNSS

General specification

Mounting type	Screw mount
Dimensions (mm)	Ø 96 x 130
Operating temperature	-40 °C to +85 °C
Certificates	IP67, IP69, IK09



Antenna and electrical specifications

5G NR/4G LTE/FirstNet/CBRS/LPWA/3G/2G (Connection 1)

Standards	5G NR/4G LTE/FirstNet/CBRS/LPWA/ CAT-X/CAT-Mx/CAT-NBx/NB-IoT/3G/2G
Frequency (MHz)	617-960, 1427-2690, 3300-5000, 5150-5925
Bands	see 5G Bands list on page 17
VSWR	~3.7:1, ~2.0:1, ~1.5:1, ~1.6:1
Efficiency (%)	~31.0, ~41.6, ~41.6, ~36.9
Peak Gain (dBi)	~1.3, ~3.4, ~4.7, ~4.0
Impedance (Ohm)	50
Polarisation	Linear
Radiation Pattern	Omni-Directional
Max. Input Power (W)	35

Antenna and electrical specifications

5G NR/4G LTE/FirstNet/CBRS/LPWA/3G/2G (Connection 2)

Standards	5G NR/4G LTE/FirstNet/CBRS/LPWA/ CAT-X/CAT-Mx/CAT-NBx/NB-IoT/3G/2G
Frequency (MHz)	617-960, 1427-2690, 3300-5000, 5150-5925
Bands	see 5G Bands list on page 17
VSWR	~3.7:1, ~1.9:1, ~1.5:1, ~1.5:1
Efficiency (%)	~31.2, ~41.4, ~42.4, ~33.1
Peak Gain (dBi)	~1.2, ~3.6, ~4.6, ~3.2
Impedance (Ohm)	50
Polarisation	Linear
Radiation Pattern	Omni-Directional
Max. Input Power (W)	35

Antenna and electrical specifications

5G NR/4G LTE/FirstNet/CBRS/LPWA/3G/2G (Connection 3)

Standards	5G NR/4G LTE/FirstNet/CBRS/LPWA/ CAT-X/CAT-Mx/CAT-NBx/NB-IoT/3G/2G
Frequency (MHz)	617-960, 1427-2690, 3300-5000, 5150-5925
Bands	see 5G Bands list on page 17
VSWR	~3.7:1, ~1.8:1, ~1.4:1, ~1.8:1
Efficiency (%)	~31.5, ~41.6, ~40.3, ~38.5
Peak Gain (dBi)	~1.3, ~3.8, ~4.5, ~4.6
Impedance (Ohm)	50
Polarisation	Linear
Radiation Pattern	Omni-Directional
Max. Input Power (W)	35

Antenna and electrical specifications

GPS/GLONASS/QZSS/Galileo/L1 (Connection 5)

Standards	GPS(L1)/GLONASS(L10F)/QZSS(L1)/Galileo(E1)
Frequency (MHz)	1575.42, 1598-1606
VSWR	<1.4:1
Impedance (Ohm)	50
Radiation Pattern	Hemispherical
Polarisation	RHCP
Active Gain (dB)	28 @ 2.7 V
Voltage (V)	1.5 - 3.6
Current Consumption (mA)	9 Typ
Power Consumption (mW)	24.3 Typ
Saw Filter Type	Pre-Filter
ESD Protection (kV)	6

Antenna and electrical specifications

5G NR/4G LTE/FirstNet/CBRS/LPWA/3G/2G (Connection 4)

Standards	5G NR/4G LTE/FirstNet/CBRS/LPWA/ CAT-X/CAT-Mx/CAT-NBx/NB-IoT/3G/2G
Frequency (MHz)	617-960, 1427-2690, 3300-5000, 5150-5925
Bands	see 5G Bands list on page 17
VSWR	~3.5:1, ~1.8:1, ~1.5:1, ~1.5:1
Efficiency (%)	~31.2, ~41.8, ~42.5, ~35.0
Peak Gain (dBi)	~1.6, ~3.4, ~4.6, ~3.9
Impedance (Ohm)	50
Polarisation	Linear
Radiation Pattern	Omni-Directional
Max. Input Power (W)	35



2J7B86BGFa 5G Antenna, Active GNSS

2x 5GNR/4GLTE/FirstNet/CBRS/LPWA/3G/2G &

2x 2.4-5.0GHz/WiFi/LPWA/BT/ISM &

GPS/GLONASS/QZSS/Galileo/L1

- Key Features**
- ✔ High Performance
 - ✔ Customizable Cable and Connector
 - ✔ Certificates: IP67 - Water Resistant, IP69 - Hot Water Pressure, IK09 - Impact Resistant
 - ✔ Ground Plane Independent
 - ✔ Lightweight Plastic Base
 - ✔ Pre-Filter GNSS

General specification

Mounting type	Screw mount
Dimensions (mm)	Ø 96 x 130
Operating temperature	-40 °C to +85 °C
Certificates	IP67, IP69, IK09



Antenna and electrical specifications

5GNR/4GLTE/FirstNet/CBRS/LPWA/3G/2G (Connection 1)

Standards	5GNR/4GLTE/FirstNet/CBRS/LPWA/ CAT-X/CAT-Mx/CAT-NBx/NB-IoT/3G/2G
Frequency (MHz)	617-960, 1427-2690, 3300-5000, 5150-5925
Bands	see 5G Bands list on page 17
VSWR	~2.5:1, ~1.4:1, ~1.4:1, ~1.3:1
Efficiency (%)	~38.5, ~45.8, ~41.6, ~36.6
Peak Gain (dBi)	~0.3, ~3.6, ~4.7, ~3.8
Impedance (Ohm)	50
Polarisation	Linear
Radiation Pattern	Omni-Directional
Max. Input Power (W)	35

Antenna and electrical specifications

5GNR/4GLTE/FirstNet/CBRS/LPWA/3G/2G (Connection 2)

Standards	5GNR/4GLTE/FirstNet/CBRS/LPWA/ CAT-X/CAT-Mx/CAT-NBx/NB-IoT/3G/2G
Frequency (MHz)	617-960, 1427-2690, 3300-5000, 5150-5925
Bands	see 5G Bands list on page 17
VSWR	~2.5:1, ~1.4:1, ~1.7:1, ~1.9:1
Efficiency (%)	~42.2, ~45.3, ~43.0, ~36.7
Peak Gain (dBi)	~0.7, ~3.7, ~4.6, ~3.6
Impedance (Ohm)	50
Polarisation	Linear
Radiation Pattern	Omni-Directional
Max. Input Power (W)	35

Antenna and electrical specifications

2.4-5.0GHz/WiFi/LPWA/BT/ISM (Connection 3)

Standards	WiFi/Sigfox/LoRa/LPWA/Bluetooth/ BLE/ZigBee/RFID/RFMA/ISM
Frequency (MHz)	2410-2490, 4920-5925
VSWR	~1.5:1, ~1.4:1
Efficiency (%)	~43.4, ~26.2
Peak Gain (dBi)	~5.3, ~1.5
Impedance (Ohm)	50
Polarisation	Linear
Radiation Pattern	Omni-Directional
Max. Input Power (W)	25

Antenna and electrical specifications

GPS/GLONASS/QZSS/Galileo/L1 (Connection 5)

Standards	GPS(L1)/GLONASS(L10F)/QZSS(L1)/Galileo(E1)
Frequency (MHz)	1575.42, 1598-1606
VSWR	<1.4:1
Impedance (Ohm)	50
Radiation Pattern	Hemispherical
Polarisation	RHCP
Active Gain (dB)	28 @ 2.7 V
Voltage (V)	1.5 - 3.6
Current Consumption (mA)	9 Typ
Power Consumption (mW)	24.3 Typ
Saw Filter Type	Pre-Filter
ESD Protection (kV)	6

Antenna and electrical specifications

2.4-5.0GHz/WiFi/LPWA/BT/ISM (Connection 4)

Standards	WiFi/Sigfox/LoRa/LPWA/Bluetooth/ BLE/ZigBee/RFID/RFMA/ISM
Frequency (MHz)	2410-2490, 4920-5925
VSWR	~1.6:1, ~1.3:1
Efficiency (%)	~41.8, ~30.9
Peak Gain (dBi)	~5.3, ~2.3
Impedance (Ohm)	50
Polarisation	Linear
Radiation Pattern	Omni-Directional
Max. Input Power (W)	25



2J7041BGFc Active GNSS 4x 4G LTE/FirstNet/LPWA/NB-IoT/3G/2G & GPS/GLONASS/QZSS/Galileo/L1

- Key Features**
- High Performance
 - Customizable Cable and Connector
 - Ground Plane Independent
 - Heavy Duty antenna with Anti-Rotation Mounting
 - Certificates: IP67 - Water Resistant, IP69 - Hot Water Pressure, IK09 - Impact Resistant
 - Certified for Railway industry
 - Pre-Filter GNSS



General specification

Mounting type	Screw mount
Dimensions (mm)	Ø 96 × 90
Operating temperature	-40 °C to +85 °C
Certificates	IP67, IP69, IK09, Certified for Railway industry

Antenna and electrical specifications

4G LTE/FirstNet/LPWA/NB-IoT/3G/2G (Connection 1)

Standards	4G LTE/FirstNet/LPWA/ CAT-X/CAT-Mx/CAT-NBx/NB-IoT/3G/2G
Frequency (MHz)	698-960, 1710-2170, 2500-2700
VSWR	~2.9:1, ~1.9:1, ~1.3:1
Efficiency (%)	~36, ~41, ~53
Peak Gain (dBi)	~36, ~41, ~53
Impedance (Ohm)	50
Polarisation	Linear
Radiation Pattern	Omni-Directional
Max. Input Power (W)	25

Antenna and electrical specifications

4G LTE/FirstNet/LPWA/NB-IoT/3G/2G (Connection 2)

Standards	4G LTE/FirstNet/LPWA/ CAT-X/CAT-Mx/CAT-NBx/NB-IoT/3G/2G
Frequency (MHz)	698-960, 1710-2170, 2500-2700
VSWR	~2.8:1, ~2.1:1, ~1.4:1
Efficiency (%)	~35, ~42, ~53
Peak Gain (dBi)	~-0.1, ~3.2, ~5.6
Impedance (Ohm)	50
Polarisation	Linear
Radiation Pattern	Omni-Directional
Max. Input Power (W)	25

Antenna and electrical specifications

4G LTE/FirstNet/LPWA/NB-IoT/3G/2G (Connection 3)

Standards	4G LTE/FirstNet/LPWA/ CAT-X/CAT-Mx/CAT-NBx/NB-IoT/3G/2G
Frequency (MHz)	698-960, 1710-2170, 2500-2700
VSWR	~2.9:1, ~2.0:1, ~1.4:1
Efficiency (%)	~35, ~40, ~53
Peak Gain (dBi)	~-0.5, ~3.1, ~5.0
Impedance (Ohm)	50
Polarisation	Linear
Radiation Pattern	Omni-Directional
Max. Input Power (W)	25

Antenna and electrical specifications

GPS/GLONASS/QZSS/Galileo/L1 (Connection 5)

Standards	GPS(L1)/GLONASS(L10F)/QZSS(L1)/Galileo(E1)
Frequency (MHz)	1575.42, 1598-1606
VSWR	<1.4:1
Impedance (Ohm)	50
Radiation Pattern	Hemispherical
Polarisation	RHCP
Active Gain (dB)	28 @ 2.7 V
Voltage (V)	1.5 - 3.6
Current Consumption (mA)	9 Typ
Power Consumption (mW)	24.3 Typ
Saw Filter Type	Pre-Filter
ESD Protection (kV)	6

Antenna and electrical specifications

4G LTE/FirstNet/LPWA/NB-IoT/3G/2G (Connection 4)

Standards	4G LTE/FirstNet/LPWA/ CAT-X/CAT-Mx/CAT-NBx/NB-IoT/3G/2G
Frequency (MHz)	698-960, 1710-2170, 2500-2700
VSWR	~2.8:1, ~2.1:1, ~1.4:1
Efficiency (%)	~36, ~42, ~54
Peak Gain (dBi)	~-0.7, ~3.0, ~4.8
Impedance (Ohm)	50
Polarisation	Linear
Radiation Pattern	Omni-Directional
Max. Input Power (W)	25



2J6550BGfA Active GNSS, for EU LTE only

2x 4GLTE/FirstNet/LPWA/NB-IoT/3G/2G &

2x 2.4-5.0GHz/WiFi/LPWA/BT/ISM &

GPS/GLONASS/QZSS/Galileo/L1

Key Features Ground Plane Dependent Customizable Cable and Connector

Certificates: IP67 - Water Resistant, IP69 - Hot Water Pressure, IK09 - Impact Resistant

Anti-rotation Mounting Pre-Filter GNSS

General specification

Mounting type	Screw mount
Dimensions (mm)	Ø 146 × 31.5
Operating temperature	-40 °C to +85 °C
Certificates	IP67, IP69, IK09

Antenna and electrical specifications

4GLTE/FirstNet/LPWA/NB-IoT/3G/2G (Connection 1)

Standards	4GLTE/FirstNet/LPWA/ CAT-X/CAT-Mx/CAT-NBx/NB-IoT/3G/2G
Frequency (MHz)	791-960, 1710-2170, 2500-2700
VSWR	~3.2:1, ~1.7:1, ~1.9:1
Efficiency (%)	~32.7, ~40.1, ~30.2
Peak Gain (dBi)	~0.4, ~2.4, ~0.7
Impedance (Ohm)	50
Polarisation	Linear
Radiation Pattern	Omni-Directional
Max. Input Power (W)	25

Antenna and electrical specifications

4GLTE/FirstNet/LPWA/NB-IoT/3G/2G (Connection 2)

Standards	4GLTE/FirstNet/LPWA/ CAT-X/CAT-Mx/CAT-NBx/NB-IoT/3G/2G
Frequency (MHz)	791-960, 1710-2170, 2500-2700
VSWR	~3.0:1, ~1.7:1, ~1.8:1
Efficiency (%)	~28.2, ~40.7, ~30.5
Peak Gain (dBi)	~-1.4, ~3.2, ~1.0
Impedance (Ohm)	50
Polarisation	Linear
Radiation Pattern	Omni-Directional
Max. Input Power (W)	25

Antenna and electrical specifications

2.4-5.0GHz/WiFi/LPWA/BT/ISM (Connection 3)

Standards	WiFi/Sigfox/LoRa/LPWA/Bluetooth/ BLE/ZigBee/RFID/RFMA/ISM
Frequency (MHz)	2410-2490, 4920-5925
VSWR	~2.2:1, ~1.4:1
Efficiency (%)	~16.4, ~20.4
Peak Gain (dBi)	~-0.6, ~-1.0
Impedance (Ohm)	50
Polarisation	Linear
Radiation Pattern	Omni-Directional
Max. Input Power (W)	25

Antenna and electrical specifications

GPS/GLONASS/QZSS/Galileo/L1 (Connection 5)

Standards	GPS(L1)/GLONASS(L10F)/QZSS(L1)/Galileo(E1)
Frequency (MHz)	1575.42, 1598-1606
VSWR	<1.4:1
Impedance (Ohm)	50
Radiation Pattern	Hemispherical
Polarisation	RHCP
Active Gain (dB)	28 @ 2.7 V
Voltage (V)	1.5 - 3.6
Current Consumption (mA)	9 Typ
Power Consumption (mW)	24.3 Typ
Saw Filter Type	Pre-Filter
ESD Protection (kV)	6



Antenna and electrical specifications

2.4-5.0GHz/WiFi/LPWA/BT/ISM (Connection 4)

Standards	WiFi/Sigfox/LoRa/LPWA/Bluetooth/ BLE/ZigBee/RFID/RFMA/ISM
Frequency (MHz)	2410-2490, 4920-5925
VSWR	~2.0:1, ~1.3:1
Efficiency (%)	~19.6, ~22.4
Peak Gain (dBi)	~-0.3, ~-0.8
Impedance (Ohm)	50
Polarisation	Linear
Radiation Pattern	Omni-Directional
Max. Input Power (W)	25

2J7050BGFa Antenna

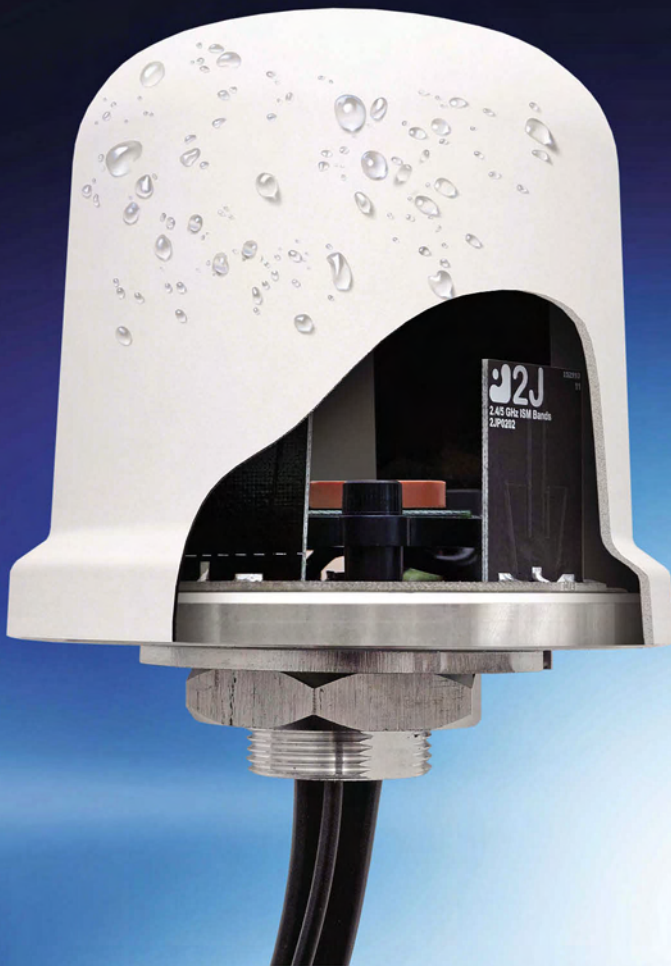

5-in-1
Antenna

2x 4GLTE/FirstNet/LPWA/NB-IoT/Cat-X-Mx-NBx/3G/2G

2x 2.4-5.0GHz/WiFi/Sigfox/LoRa/LPWA/BT/ZigBee/RFID/ISM

GPS/GLONASS/QZSS/Galileo/L1

The heavy-duty antenna that offers multiple technologies in one small form factor

With one of the smallest form factor designs, this antenna is packed with a 5-in-1 configuration. Providing connectivity for LTE-MIMO, Dual-Band WiFi-MIMO, GNSS - GPS and GLONASS, it makes it ideal for international use in applications where data integrity is a must. With a high gain and up to 60% efficiency across worldwide 4G LTE, 3G and 2G bands, the 2J7050BGFa antenna makes a superior candidate for high-end public safety applications such as police, ambulance, fire services, HD video broadcasting, resource management, transportation, critical communications and other industries.

Having an extremely low ECC (Envelope Correlation Coefficient) allows for low latency and high data transfer rates. High gain, low noise and pre-filtered GNSS allow for more accurate geo-location and navigation, as well as high performance dual-band Wi-Fi-MIMO antennas for better signal reception.

The 2J7050BGFa system provides five output cables connected to the respective antennas. Cables one and two allow access to the Cellular/LTE antenna creating the MIMO configuration for this application. Cables three and four are allocated to 2.4GHz and 5.0GHz ISM antennas providing the same MIMO configuration. Cable five serves access to the GPS/GLONASS/GNSS antenna.

Installation

This screw mount antenna comes with low loss cables thread through a single mounting hole for easy installation. This antenna provides an anti-rotation mounting design, removing the possibility of cables getting cut through the lifetime of the product. Cables and connectors can be customized to specific requirements based on the end-use application and needs.

Durability

The IP67 and IP69 ingress ratings provide this compact antenna with maximum protection against dust and water penetration, while the IK09 rating adds an extra level of anti-vandal security, with high impact resistance. This antenna design has also been tested to comply with EN61373 (Vibration and Shock) and EN45545-2 (Fire Protection) for use in railway applications while the UV stable housing material is available in a range of colored finishes.



2J7050BGfA Active GNSS

2x 4G LTE/FirstNet/LPWA/NB-IoT/3G/2G &
2x 2.4-5.0GHz/WiFi/LPWA/BT/ISM &
GPS/GLONASS/QZSS/Galileo/L1

- Key Features**
- ✔ High Performance
 - ✔ Customizable Cable and Connector
 - ✔ Ground Plane Independent
 - ✔ Heavy Duty antenna with Anti-Rotation Mounting
 - ✔ Certificates: IP67 - Water Resistant, IP69 - Hot Water Pressure, IK09 - Impact Resistant
 - ✔ Certified for Railway industry
 - ✔ Pre-Filter GNSS

General specification

Mounting type	Screw mount
Dimensions (mm)	Ø 96 x 90
Operating temperature	-40 °C to +85 °C
Certificates	IP67, IP69, IK09, Certified for Railway industry



Antenna and electrical specifications

4G LTE/FirstNet/LPWA/NB-IoT/3G/2G (Connection 1)

Standards	4G LTE/FirstNet/LPWA/ CAT-X/CAT-Mx/CAT-NBx/NB-IoT/3G/2G
Frequency (MHz)	698-960, 1710-2170, 2500-2700
VSWR	~1.9:1, ~1.6:1, ~1.7:1
Efficiency (%)	~57, ~57, ~47
Peak Gain (dBi)	~2.1, ~4.2, ~3.1
Impedance (Ohm)	50
Polarisation	Linear
Radiation Pattern	Omni-Directional
Max. Input Power (W)	25

Antenna and electrical specifications

4G LTE/FirstNet/LPWA/NB-IoT/3G/2G (Connection 2)

Standards	4G LTE/FirstNet/LPWA/ CAT-X/CAT-Mx/CAT-NBx/NB-IoT/3G/2G
Frequency (MHz)	698-960, 1710-2170, 2500-2700
VSWR	~1.9:1, ~1.6:1, ~1.4:1
Efficiency (%)	~63, ~54, ~57
Peak Gain (dBi)	~3.0, ~3.2, ~4.0
Impedance (Ohm)	50
Polarisation	Linear
Radiation Pattern	Omni-Directional
Max. Input Power (W)	25

Antenna and electrical specifications

2.4-5.0GHz/WiFi/LPWA/BT/ISM (Connection 3)

Standards	WiFi/Sigfox/LoRa/LPWA/Bluetooth/ BLE/ZigBee/RFID/RPMA/ISM
Frequency (MHz)	2410-2490, 4920-5925
VSWR	~1.9:1, ~1.6:1
Efficiency (%)	~58, ~64
Peak Gain (dBi)	~5.6, ~5.5
Impedance (Ohm)	50
Polarisation	Linear
Radiation Pattern	Omni-Directional
Max. Input Power (W)	25

Antenna and electrical specifications

GPS/GLONASS/QZSS/Galileo/L1 (Connection 5)

Standards	GPS(L1)/GLONASS(L10F)/QZSS(L1)/Galileo(E1)
Frequency (MHz)	1575.42, 1598-1606
VSWR	<1.5:1
Impedance (Ohm)	50
Radiation Pattern	Hemispherical
Polarisation	RHCP
Active Gain (dB)	28 @ 2.7 V
Voltage (V)	1.5 - 3.6
Current Consumption (mA)	9 Typ
Power Consumption (mW)	24.3 Typ
Saw Filter Type	Pre-Filter
ESD Protection (kV)	6

Antenna and electrical specifications

2.4-5.0GHz/WiFi/LPWA/BT/ISM (Connection 4)

Standards	WiFi/Sigfox/LoRa/LPWA/Bluetooth/ BLE/ZigBee/RFID/RPMA/ISM
Frequency (MHz)	2410-2490, 4920-5925
VSWR	~2.1:1, ~1.6:1
Efficiency (%)	~57, ~59
Peak Gain (dBi)	~5.5, ~4.4
Impedance (Ohm)	50
Polarisation	Linear
Radiation Pattern	Omni-Directional
Max. Input Power (W)	25



2J7068BGFa-868 Active GNSS

2x 4GLTE/FirstNet/LPWA/NB-IoT/3G/2G & GPS/GLONASS/QZSS/Galileo/L1 & 2.4-5.0GHz/WiFi/LPWA/BT/ISM & 868MHz/Sigfox/LoRa/LPWA/RFID/ZigBee/ISM

- Key Features**
- ✔ High Performance
 - ✔ Customizable Cable and Connector
 - ✔ Ground Plane Independent
 - ✔ Heavy Duty antenna with Anti-Rotation Mounting
 - ✔ Certificates: IP67 - Water Resistant, IP69 - Hot Water Pressure, IK09 - Impact Resistant
 - ✔ Certified for Railway industry
 - ✔ Pre-Filter GNSS



White Black

Standard colors.
Other colors upon request.

General specification

Mounting type	Screw mount
Dimensions (mm)	Ø 96 × 90
Operating temperature	-40 °C to +85 °C
Certificates	IP67, IP69, IK09, Certified for Railway industry

Antenna and electrical specifications

4GLTE/FirstNet/LPWA/NB-IoT/3G/2G (Connection 1)

Standards	4GLTE/FirstNet/LPWA/ CAT-X/CAT-Mx/CAT-NBx/NB-IoT/3G/2G
Frequency (MHz)	698-960, 1710-2170, 2500-2700
VSWR	~2.9:1, ~1.9:1, ~1.3:1
Efficiency (%)	~36, ~41, ~53
Peak Gain (dBi)	~0.2, ~3.8, ~6.0
Impedance (Ohm)	50
Polarisation	Linear
Radiation Pattern	Omni-Directional
Max. Input Power (W)	25

Antenna and electrical specifications

4GLTE/FirstNet/LPWA/NB-IoT/3G/2G (Connection 2)

Standards	4GLTE/FirstNet/LPWA/ CAT-X/CAT-Mx/CAT-NBx/NB-IoT/3G/2G
Frequency (MHz)	698-960, 1710-2170, 2500-2700
VSWR	~2.8:1, ~2.1:1, ~1.4:1
Efficiency (%)	~35, ~42, ~53
Peak Gain (dBi)	~-0.1, ~3.2, ~5.6
Impedance (Ohm)	50
Polarisation	Linear
Radiation Pattern	Omni-Directional
Max. Input Power (W)	25

Antenna and electrical specifications

GPS/GLONASS/QZSS/Galileo/L1 (Connection 3)

Standards	GPS(L1)/GLONASS(L10F)/QZSS(L1)/Galileo(E1)
Frequency (MHz)	1575.42, 1598-1606
VSWR	<1.5:1
Impedance (Ohm)	50
Radiation Pattern	Hemispherical
Polarisation	RHCP
Active Gain (dB)	28 @ 2.7 V
Voltage (V)	1.5 - 3.6
Current Consumption (mA)	9 Typ
Power Consumption (mW)	24.3 Typ
Saw Filter Type	Pre-Filter
ESD Protection (kV)	6

Antenna and electrical specifications

2.4-5.0GHz/WiFi/LPWA/BT/ISM (Connection 4)

Standards	WiFi/Sigfox/LoRa/LPWA/Bluetooth/ BLE/ZigBee/RFID/RFMA/ISM
Frequency (MHz)	2410-2490, 4920-5925
VSWR	~1.9:1, ~1.6:1
Efficiency (%)	~58, ~64
Peak Gain (dBi)	~5.6, ~5.5
Impedance (Ohm)	50
Polarisation	Linear
Radiation Pattern	Omni-Directional
Max. Input Power (W)	25

Antenna and electrical specifications

868MHz/Sigfox/LoRa/LPWA/RFID/ZigBee/ISM (Connection 5)

Standards	Sigfox/LoRa/ZigBee/RFID/LPWA/ISM/UHF
Frequency (MHz)	863-870
VSWR	~2.3:1
Efficiency (%)	~37
Peak Gain (dBi)	~0.51
Impedance (Ohm)	50
Polarisation	Linear
Radiation Pattern	Omni-Directional
Max. Input Power (W)	25



2J7068BGFa-915 Active GNSS

2x 4G LTE/FirstNet/LPWA/NB-IoT/3G/2G & GPS/GLONASS/QZSS/Galileo/L1 & 2.4-5.0GHz/WiFi/LPWA/BT/ISM & 915MHz/Sigfox/LoRa/LPWA/RFID/ZigBee/ISM

- Key Features**
- ✔ High Performance
 - ✔ Customizable Cable and Connector
 - ✔ Ground Plane Independent
 - ✔ Heavy Duty antenna with Anti-Rotation Mounting
 - ✔ Certificates: IP67 - Water Resistant, IP69 - Hot Water Pressure, IK09 - Impact Resistant
 - ✔ Certified for Railway industry
 - ✔ Pre-Filter GNSS



White Black
Standard colors.
Other colors upon request.

General specification

Mounting type	Screw mount
Dimensions (mm)	Ø 96 × 90
Operating temperature	-40 °C to +85 °C
Certificates	IP67, IP69, IK09, Certified for Railway industry

Antenna and electrical specifications

4G LTE/FirstNet/LPWA/NB-IoT/3G/2G (Connection 1)

Standards	4G LTE/FirstNet/LPWA/ CAT-X/CAT-Mx/CAT-NBx/NB-IoT/3G/2G
Frequency (MHz)	698-960, 1710-2170, 2500-2700
VSWR	~2.9:1, ~1.9:1, ~1.3:1
Efficiency (%)	~36, ~41, ~53
Peak Gain (dBi)	~0.2, ~3.8, ~6.0
Impedance (Ohm)	50
Polarisation	Linear
Radiation Pattern	Omni-Directional
Max. Input Power (W)	25

Antenna and electrical specifications

4G LTE/FirstNet/LPWA/NB-IoT/3G/2G (Connection 2)

Standards	4G LTE/FirstNet/LPWA/ CAT-X/CAT-Mx/CAT-NBx/NB-IoT/3G/2G
Frequency (MHz)	698-960, 1710-2170, 2500-2700
VSWR	~2.8:1, ~2.1:1, ~1.4:1
Efficiency (%)	~35, ~42, ~53
Peak Gain (dBi)	~0.1, ~3.2, ~5.6
Impedance (Ohm)	50
Polarisation	Linear
Radiation Pattern	Omni-Directional
Max. Input Power (W)	25

Antenna and electrical specifications

GPS/GLONASS/QZSS/Galileo/L1 (Connection 3)

Standards	GPS(L1)/GLONASS(L1O/F)/QZSS(L1)/Galileo(E1)
Frequency (MHz)	1575.42, 1598-1606
VSWR	<1.5:1
Impedance (Ohm)	50
Radiation Pattern	Hemispherical
Polarisation	RHCP
Active Gain (dB)	28 @ 2.7 V
Voltage (V)	1.5 - 3.6
Current Consumption (mA)	9 Typ
Power Consumption (mW)	24.3 Typ
Saw Filter Type	Pre-Filter
ESD Protection (kV)	6

Antenna and electrical specifications

2.4-5.0GHz/WiFi/LPWA/BT/ISM (Connection 4)

Standards	WiFi/Sigfox/LoRa/LPWA/Bluetooth/ BLE/ZigBee/RFID/RFMA/ISM
Frequency (MHz)	2410-2490, 4920-5925
VSWR	~1.9:1, ~1.6:1
Efficiency (%)	~58, ~64
Peak Gain (dBi)	~5.6, ~5.5
Impedance (Ohm)	50
Polarisation	Linear
Radiation Pattern	Omni-Directional
Max. Input Power (W)	25

Antenna and electrical specifications

915MHz/Sigfox/LoRa/LPWA/RFID/ZigBee/ISM (Connection 5)

Standards	Sigfox/LoRa/ZigBee/RFID/LPWA/ISM/UHF
Frequency (MHz)	902-928
VSWR	~2.3:1
Efficiency (%)	~36
Peak Gain (dBi)	~0.5
Impedance (Ohm)	50
Polarisation	Linear
Radiation Pattern	Omni-Directional
Max. Input Power (W)	25



2J6083Pa 5G Antenna

2x 5G NR/4G LTE/FirstNet/CBRS/LPWA/3G/2G

- Key Features**
- ✔ Low Profile
 - ✔ Ground Plane Independent
 - ✔ Customizable Cable and Connector

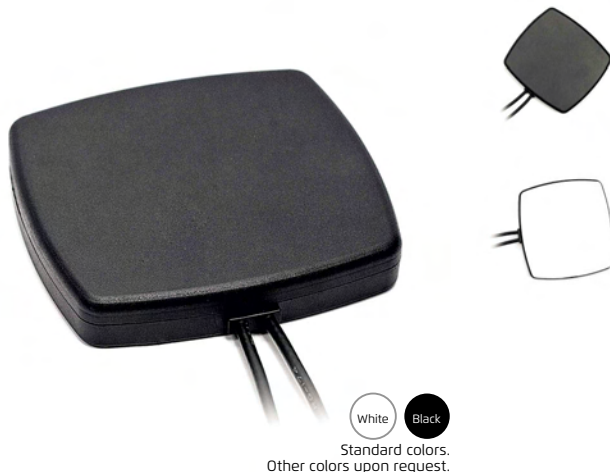

White Black

Standard colors.
Other colors upon request.

General specification

Mounting type	Adhesive mount
Dimensions (mm)	80 × 76 × 16
Operating temperature	-40 °C to +85 °C

Antenna and electrical specifications

5G NR/4G LTE/FirstNet/CBRS/LPWA/3G/2G (Connection 1)

Standards	5G NR/4G LTE/FirstNet/CBRS/LPWA/ CAT-X/CAT-Mx/CAT-NBx/NB-IoT/3G/2G
Frequency (MHz)	617-960, 1427-2690, 3300-5000, 5150-5925
Bands	see 5G Bands list on page 17
VSWR	~2.8:1, ~1.7:1, ~2.4:1, ~2.2:1
Efficiency (%)	~51.4, ~58.4, ~37.2, ~39.7
Peak Gain (dBi)	~3.6, ~4.2, ~1.2, ~1.8
Impedance (Ohm)	50
Polarisation	Linear
Radiation Pattern	Omni-Directional
Max. Input Power (W)	25

Antenna and electrical specifications

5G NR/4G LTE/FirstNet/CBRS/LPWA/3G/2G (Connection 2)

Standards	5G NR/4G LTE/FirstNet/CBRS/LPWA/ CAT-X/CAT-Mx/CAT-NBx/NB-IoT/3G/2G
Frequency (MHz)	617-960, 1427-2690, 3300-5000, 5150-5925
Bands	see 5G Bands list on page 17
VSWR	~2.4:1, ~1.7:1, ~2.3:1, ~2.1:1
Efficiency (%)	~50.4, ~63.0, ~38.0, ~38.2
Peak Gain (dBi)	~2.4, ~4.2, ~2.0, ~1.9
Impedance (Ohm)	50
Polarisation	Linear
Radiation Pattern	Omni-Directional
Max. Input Power (W)	25

2J4884PGF 5G Antenna, Active GNSS

5G NR/4G LTE/FirstNet/CBRS/LPWA/3G/2G & GPS/GLONASS/QZSS/Galileo/L1

- Key Features**
- ✔ Ground Plane Independent
 - ✔ Customizable Cable and Connector
 - ✔ Certificates: IP67 - Water Resistant, IP69 - Hot Water Pressure
 - ✔ Low Profile
 - ✔ Pre-Filter GNSS



White Black

Standard colors.
Other colors upon request.

General specification

Mounting type	Adhesive mount
Dimensions (mm)	83 × 35 × 13.3
Operating temperature	-40 °C to +85 °C
Certificates	IP67, IP69

Antenna and electrical specifications

5G NR/4G LTE/FirstNet/CBRS/LPWA/3G/2G (Connection 1)

Standards	5G NR/4G LTE/FirstNet/CBRS/LPWA/ CAT-X/CAT-Mx/CAT-NBx/NB-IoT/3G/2G
Frequency (MHz)	617-960, 1427-2690, 3300-5000, 5150-5925
Bands	see 5G Bands list on page 17
VSWR	~2.1:1, ~1.6:1, ~1.7:1, ~1.5:1
Efficiency (%)	~52.0, ~44.7, ~30.7, ~27.0
Peak Gain (dBi)	~3.3, ~2.0, ~0.5, ~0.6
Impedance (Ohm)	50
Polarisation	Linear
Radiation Pattern	Omni-Directional
Max. Input Power (W)	25

Antenna and electrical specifications

GPS/GLONASS/QZSS/Galileo/L1 (Connection 2)

Standards	GPS(L1)/GLONASS(L10F)/QZSS(L1)/Galileo(E1)
Frequency (MHz)	1575.42, 1598-1606
VSWR	<1.4:1
Impedance (Ohm)	50
Radiation Pattern	Hemispherical
Polarisation	RHCP
Active Gain (dB)	28 @ 2.7 V
Voltage (V)	1.5 - 3.6
Current Consumption (mA)	9 Typ
Power Consumption (mW)	24.3 Typ
Saw Filter Type	Pre-Filter
ESD Protection (kV)	2



2J4A24Pa

2x 4GLTE/FirstNet/LPWA/NB-IoT/3G/2G

Key Features High Performance Ground Plane Independent

Certificates: IP67 - Water Resistant, IP69 - Hot Water Pressure

Customizable Cable and Connector Low Profile

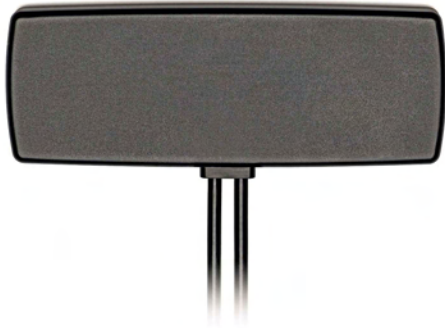

Standard colors.
Other colors upon request.

General specification

Mounting type	Adhesive mount
Dimensions (mm)	61.8 x 155.6 x 17.0
Operating temperature	-40 °C to +85 °C
Certificates	IP67, IP69

Antenna and electrical specifications

4GLTE/FirstNet/LPWA/NB-IoT/3G/2G (Connection 1)

Standards	4GLTE/FirstNet/LPWA/ CAT-X/CAT-Mx/CAT-NBx/NB-IoT/3G/2G
Frequency (MHz)	698-960, 1710-2170, 2500-2700
VSWR	~1.8:1, ~1.3:1, ~1.9:1
Efficiency (%)	~52.9, ~63.2, ~45.1
Peak Gain (dBi)	~2.2, ~3.6, ~2.9
Impedance (Ohm)	50
Polarisation	Linear
Radiation Pattern	Omni-Directional
Max. Input Power (W)	25

Antenna and electrical specifications

4GLTE/FirstNet/LPWA/NB-IoT/3G/2G (Connection 2)

Standards	4GLTE/FirstNet/LPWA/ CAT-X/CAT-Mx/CAT-NBx/NB-IoT/3G/2G
Frequency (MHz)	698-960, 1710-2170, 2500-2700
VSWR	~2.0:1, ~1.4:1, ~1.4:1
Efficiency (%)	~45.1, ~58.9, ~49.9
Peak Gain (dBi)	~1.1, ~4.4, ~4.2
Impedance (Ohm)	50
Polarisation	Linear
Radiation Pattern	Omni-Directional
Max. Input Power (W)	25

2J6024Pa

2x 4GLTE/FirstNet/LPWA/NB-IoT/3G/2G

Key Features Low Profile Ground Plane Independent

Customizable Cable and Connector

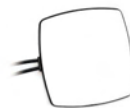
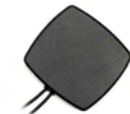

Standard colors.
Other colors upon request.

General specification

Mounting type	Adhesive mount
Dimensions (mm)	80 x 76 x 16
Operating temperature	-40 °C to +85 °C

Antenna and electrical specifications

4GLTE/FirstNet/LPWA/NB-IoT/3G/2G (Connection 1)

Standards	4GLTE/FirstNet/LPWA/ CAT-X/CAT-Mx/CAT-NBx/NB-IoT/3G/2G
Frequency (MHz)	698-960, 1710-2170, 2500-2700
VSWR	~2.2:1, ~1.2:1, ~2.2:1
Efficiency (%)	~55.6, ~56.0, ~38.7
Peak Gain (dBi)	~2.9, ~3.2, ~2.1
Impedance (Ohm)	50
Polarisation	Linear
Radiation Pattern	Omni-Directional
Max. Input Power (W)	25

Antenna and electrical specifications

4GLTE/FirstNet/LPWA/NB-IoT/3G/2G (Connection 2)

Standards	4GLTE/FirstNet/LPWA/ CAT-X/CAT-Mx/CAT-NBx/NB-IoT/3G/2G
Frequency (MHz)	698-960, 1710-2170, 2500-2700
VSWR	~2.2:1, ~1.2:1, ~2.2:1
Efficiency (%)	~55.6, ~56.0, ~38.7
Peak Gain (dBi)	~2.9, ~3.2, ~2.1
Impedance (Ohm)	50
Polarisation	Linear
Radiation Pattern	Omni-Directional
Max. Input Power (W)	25



2J4441PGF Active GNSS 4GLTE/FirstNet/LPWA/NB-IoT/3G/2G & GPS/GLONASS/QZSS/Galileo/L1

- Key Features**
- ✔ Ground Plane Independent
 - ✔ Customizable Cable and Connector
 - ✔ Certificates: IP67 - Water Resistant
 - ✔ Low Profile
 - ✔ Post-Filter GNSS



Standard colors.
Other colors upon request.

General specification

Mounting type	Adhesive mount
Dimensions (mm)	161 × 76.5 × 16
Operating temperature	-40 °C to +85 °C
Certificates	IP67

Antenna and electrical specifications

4GLTE/FirstNet/LPWA/NB-IoT/3G/2G (Connection 1)

Standards	4GLTE/FirstNet/LPWA/ CAT-X/CAT-Mx/CAT-NBx/NB-IoT/3G/2G
Frequency (MHz)	698-960, 1710-2170, 2500-2700
VSWR	~2.2:1, ~1.3:1, ~1.7:1
Efficiency (%)	~72, ~71, ~71
Peak Gain (dBi)	~3.1, ~4.1, ~3.7
Impedance (Ohm)	50
Polarisation	Linear
Radiation Pattern	Omni-Directional
Max. Input Power (W)	35

Antenna and electrical specifications

GPS/GLONASS/QZSS/Galileo/L1 (Connection 2)

Standards	GPS(L1)/GLONASS(L1OF)/QZSS(L1)/Galileo(E1)
Frequency (MHz)	1575.42, 1598-1606
VSWR	<1.5:1
Impedance (Ohm)	50
Radiation Pattern	Hemispherical
Polarisation	RHCP
Active Gain (dB)	23 @ 3V / 24 @ 5V
Voltage (V)	2.7 - 5.5
Current Consumption (mA)	15 - 25
Power Consumption (mW)	40.5 - 137.5
Saw Filter Type	Post-Filter

2J4441PGFR Active GNSS 4GLTE/FirstNet/LPWA/NB-IoT/3G/2G & GPS/GLONASS/QZSS/Galileo/L1

- Key Features**
- ✔ Ground Plane Independent
 - ✔ Customizable Cable and Connector
 - ✔ Certificates: IP67 - Water Resistant
 - ✔ Low Profile
 - ✔ Post-Filter GNSS
 - ✔ In-built 10K resistor for antenna detection



Standard colors.
Other colors upon request.

General specification

Mounting type	Adhesive mount
Dimensions (mm)	161 × 76.5 × 16
Operating temperature	-40 °C to +85 °C
Certificates	IP67

Antenna and electrical specifications

4GLTE/FirstNet/LPWA/NB-IoT/3G/2G (Connection 1)

Standards	4GLTE/FirstNet/LPWA/ CAT-X/CAT-Mx/CAT-NBx/NB-IoT/3G/2G
Frequency (MHz)	698-960, 1710-2170, 2500-2700
VSWR	~2.2:1, ~1.3:1, ~1.7:1
Efficiency (%)	~72, ~71, ~71
Peak Gain (dBi)	~3.1, ~4.1, ~3.7
Impedance (Ohm)	50
Polarisation	Linear
Radiation Pattern	Omni-Directional
Max. Input Power (W)	35

Antenna and electrical specifications

GPS/GLONASS/QZSS/Galileo/L1 (Connection 2)

Standards	GPS(L1)/GLONASS(L1OF)/QZSS(L1)/Galileo(E1)
Frequency (MHz)	1575.42, 1598-1606
VSWR	<1.5:1
Impedance (Ohm)	50
Radiation Pattern	Hemispherical
Polarisation	RHCP
Active Gain (dB)	23 @ 3V / 24 @ 5V
Voltage (V)	2.7 - 5.5
Current Consumption (mA)	15 - 25
Power Consumption (mW)	40.5 - 137.5
Saw Filter Type	Post-Filter



2J4841PGF Active GNSS 4GLTE/FirstNet/LPWA/NB-IoT/3G/2G & GPS/GLONASS/QZSS/Galileo/L1

- Key Features**
- ✔ Ground Plane Independent
 - ✔ Customizable Cable and Connector
 - ✔ Certificates: IP67 - Water Resistant, IP69 - Hot Water Pressure
 - ✔ Low Profile
 - ✔ Pre-Filter GNSS
 - ✔ Optional Antenna Detection Resistor



White Black
Standard colors.
Other colors upon request.

General specification

Mounting type	Adhesive mount
Dimensions (mm)	83 × 35 × 13.3
Operating temperature	-40 °C to +85 °C
Certificates	IP67, IP69

Antenna and electrical specifications

4GLTE/FirstNet/LPWA/NB-IoT/3G/2G (Connection 1)

Standards	4GLTE/FirstNet/LPWA/ CAT-X/CAT-Mx/CAT-NBx/NB-IoT/3G/2G
Frequency (MHz)	698-960, 1710-2170, 2500-2700
VSWR	~1.8:1, ~1.3:1, ~2.0:1
Efficiency (%)	~53, ~49, ~25
Peak Gain (dBi)	~2.4, ~1.3, ~0.4
Impedance (Ohm)	50
Polarisation	Linear
Radiation Pattern	Omni-Directional
Max. Input Power (W)	25

Antenna and electrical specifications

GPS/GLONASS/QZSS/Galileo/L1 (Connection 2)

Standards	GPS(L1)/GLONASS(L10F)/QZSS(L1)/Galileo(E1)
Frequency (MHz)	1575.42, 1598-1606
VSWR	<1.4:1
Impedance (Ohm)	50
Radiation Pattern	Hemispherical
Polarisation	RHCP
Active Gain (dB)	28 @ 2.7 V
Voltage (V)	1.5 - 3.6
Current Consumption (mA)	9 Typ
Power Consumption (mW)	24.3 Typ
Saw Filter Type	Pre-Filter
ESD Protection (kV)	2

2J4941PGF Active GNSS 4GLTE/FirstNet/LPWA/NB-IoT/3G/2G & GPS/GLONASS/QZSS/Galileo/L1

- Key Features**
- ✔ Ground Plane Independent
 - ✔ Customizable Cable and Connector
 - ✔ Certificates: IP67 - Water Resistant, IP69 - Hot Water Pressure
 - ✔ High Performance
 - ✔ Pre-Filter GNSS
 - ✔ Optional Antenna Detection Resistor



White Black
Standard colors.
Other colors upon request.

General specification

Mounting type	Adhesive mount
Dimensions (mm)	150.5 × 42 × 15.3
Operating temperature	-40 °C to +85 °C
Certificates	IP67, IP69

Antenna and electrical specifications

4GLTE/FirstNet/LPWA/NB-IoT/3G/2G (Connection 1)

Standards	4GLTE/FirstNet/LPWA/ CAT-X/CAT-Mx/CAT-NBx/NB-IoT/3G/2G
Frequency (MHz)	698-960, 1710-2170, 2500-2700
VSWR	~1.7:1, ~1.4:1, ~1.5:1
Efficiency (%)	~76, ~69, ~76
Peak Gain (dBi)	~3.4, ~3.5, ~3.9
Impedance (Ohm)	50
Polarisation	Linear
Radiation Pattern	Omni-Directional
Max. Input Power (W)	25

Antenna and electrical specifications

GPS/GLONASS/QZSS/Galileo/L1 (Connection 2)

Standards	GPS(L1)/GLONASS(L10F)/QZSS(L1)/Galileo(E1)
Frequency (MHz)	1575.42, 1598-1606
VSWR	<1.4:1
Impedance (Ohm)	50
Radiation Pattern	Hemispherical
Polarisation	RHCP
Active Gain (dB)	28 @ 2.7 V
Voltage (V)	1.5 - 3.6
Current Consumption (mA)	9 Typ
Power Consumption (mW)	24.3 Typ
Saw Filter Type	Pre-Filter
ESD Protection (kV)	2



2J6041PGF Active GNSS 4GLTE/FirstNet/LPWA/NB-IoT/3G/2G & GPS/GLONASS/QZSS/Galileo/L1

- Key Features**
- ✔ Low Profile
 - ✔ Ground Plane Independent
 - ✔ Customizable Cable and Connector
 - ✔ Pre-Filter GNSS

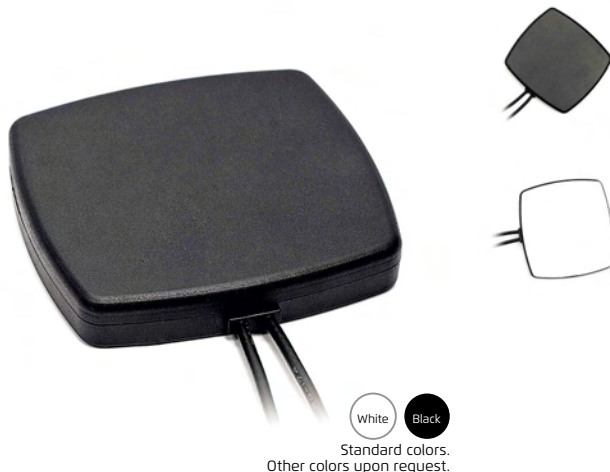

White Black
Standard colors.
Other colors upon request.

General specification

Mounting type	Adhesive mount
Dimensions (mm)	80 × 76 × 16
Operating temperature	-40 °C to +85 °C

Antenna and electrical specifications

4GLTE/FirstNet/LPWA/NB-IoT/3G/2G (Connection 1)

Standards	4GLTE/FirstNet/LPWA/ CAT-X/CAT-Mx/CAT-NBx/NB-IoT/3G/2G
Frequency (MHz)	698-960, 1710-2170, 2500-2700
VSWR	~2.2:1, ~1.2:1, ~2.2:1
Efficiency (%)	~55.6, ~56.0, ~38.7
Peak Gain (dBi)	~2.9, ~3.2, ~2.1
Impedance (Ohm)	50
Polarisation	Linear
Radiation Pattern	Omni-Directional
Max. Input Power (W)	25

Antenna and electrical specifications

GPS/GLONASS/QZSS/Galileo/L1 (Connection 2)

Standards	GPS(L1)/GLONASS(L1OF)/QZSS(L1)/Galileo(E1)
Frequency (MHz)	1575.42, 1598-1606
VSWR	<1.4:1
Impedance (Ohm)	50
Radiation Pattern	Hemispherical
Polarisation	RHCP
Active Gain (dB)	28 @ 2.7 V
Voltage (V)	1.5 - 3.6
Current Consumption (mA)	9 Typ
Power Consumption (mW)	24.3 Typ
Saw Filter Type	Pre-Filter
ESD Protection (kV)	2

2J4841PCF Active GNSS 4GLTE/FirstNet/LPWA/NB-IoT/3G/2G & GPS/GLONASS/BEIDOU/QZSS/Galileo/L1

- Key Features**
- ✔ Ground Plane Independent
 - ✔ Customizable Cable and Connector
 - ✔ Certificates: IP67 - Water Resistant, IP69 - Hot Water Pressure
 - ✔ Low Profile
 - ✔ Pre-Filter GNSS
 - ✔ Optional Antenna Detection Resistor



White Black
Standard colors.
Other colors upon request.

General specification

Mounting type	Adhesive mount
Dimensions (mm)	83 × 35 × 13.3
Operating temperature	-40 °C to +85 °C
Certificates	IP67, IP69

Antenna and electrical specifications

4GLTE/FirstNet/LPWA/NB-IoT/3G/2G (Connection 1)

Standards	4GLTE/FirstNet/LPWA/ CAT-X/CAT-Mx/CAT-NBx/NB-IoT/3G/2G
Frequency (MHz)	698-960, 1710-2170, 2500-2700
VSWR	~1.8:1, ~1.3:1, ~2.0:1
Efficiency (%)	~53, ~49, ~25
Peak Gain (dBi)	~2.4, ~1.3, ~0.4
Impedance (Ohm)	50
Polarisation	Linear
Radiation Pattern	Omni-Directional
Max. Input Power (W)	25

Antenna and electrical specifications

GPS/GLONASS/QZSS/Galileo/L1 (Connection 2)

Standards	GPS(L1)/GLONASS(L1OF)/QZSS(L1)/Galileo(E1)
Frequency (MHz)	1575.42, 1598-1606
VSWR	<1.4:1
Impedance (Ohm)	50
Radiation Pattern	Hemispherical
Polarisation	RHCP
Active Gain (dB)	28 @ 2.7 V
Voltage (V)	1.5 - 3.6
Current Consumption (mA)	9 Typ
Power Consumption (mW)	24.3 Typ
Saw Filter Type	Pre-Filter
ESD Protection (kV)	2



2J4847P

4G LTE/FirstNet/LPWA/NB-IoT/3G/2G & 2.4-5.0GHz/WiFi/LPWA/BT/ISM

- Key Features**
- ✔ Ground Plane Independent
 - ✔ Customizable Cable and Connector
 - ✔ Certificates: IP67 - Water Resistant, IP69 - Hot Water Pressure
 - ✔ Low Profile
 - ✔ Optional Antenna Detection Resistor



Standard colors.
Other colors upon request.

General specification

Mounting type	Adhesive mount
Dimensions (mm)	83 × 35 × 13.3
Operating temperature	-40 °C to +85 °C
Certificates	IP67, IP69

Antenna and electrical specifications

4G LTE/FirstNet/LPWA/NB-IoT/3G/2G (Connection 1)

Standards	4G LTE/FirstNet/LPWA/ CAT-X/CAT-Mx/CAT-NBx/NB-IoT/3G/2G
Frequency (MHz)	698-960, 1710-2170, 2500-2700
VSWR	~1.9:1, ~1.4:1, ~1.8:1
Efficiency (%)	~50, ~47, ~27
Peak Gain (dBi)	~2.0, ~1.0, ~-0.6
Impedance (Ohm)	50
Polarisation	Linear
Radiation Pattern	Omni-Directional
Max. Input Power (W)	25

Antenna and electrical specifications

2.4-5.0GHz/WiFi/LPWA/BT/ISM (Connection 2)

Standards	WiFi/Sigfox/LoRa/LPWA/Bluetooth/ BLE/ZigBee/RFID/RFMA/ISM
Frequency (MHz)	2410-2490, 4920-5925
VSWR	~1.2:1, ~1.3:1
Efficiency (%)	~42, ~27
Peak Gain (dBi)	~2.5, ~0.5
Impedance (Ohm)	50
Polarisation	Linear
Radiation Pattern	Omni-Directional
Max. Input Power (W)	25

2J6047P

4G LTE/FirstNet/LPWA/NB-IoT/3G/2G & 2.4-5.0GHz/WiFi/LPWA/BT/ISM

- Key Features**
- ✔ Low Profile
 - ✔ Ground Plane Independent
 - ✔ Customizable Cable and Connector



Standard colors.
Other colors upon request.

General specification

Mounting type	Adhesive mount
Dimensions (mm)	80 × 76 × 16
Operating temperature	-40 °C to +85 °C

Antenna and electrical specifications

4G LTE/FirstNet/LPWA/NB-IoT/3G/2G (Connection 1)

Standards	4G LTE/FirstNet/LPWA/ CAT-X/CAT-Mx/CAT-NBx/NB-IoT/3G/2G
Frequency (MHz)	698-960, 1710-2170, 2500-2700
VSWR	~2.6:1, ~1.2:1, ~1.6:1
Efficiency (%)	~46.9, ~65.6, ~53.8
Peak Gain (dBi)	~3.4, ~4.6, ~4.1
Impedance (Ohm)	50
Polarisation	Linear
Radiation Pattern	Omni-Directional
Max. Input Power (W)	25

Antenna and electrical specifications

2.4-5.0GHz/WiFi/LPWA/BT/ISM (Connection 2)

Standards	WiFi/Sigfox/LoRa/LPWA/Bluetooth/ BLE/ZigBee/RFID/RFMA/ISM
Frequency (MHz)	2410-2490, 4920-5925
VSWR	~1.8:1, ~1.4:1
Efficiency (%)	~48.6, ~35.5
Peak Gain (dBi)	~4.0, ~3.6
Impedance (Ohm)	50
Polarisation	Linear
Radiation Pattern	Omni-Directional
Max. Input Power (W)	25



2J6200PF Active GNSS

3G/2G/CELLULAR &
GPS/QZSS/Galileo/L1

- Key Features** ✓ Ground Plane Independent ✓ Customizable Cable and Connector
✓ Low Profile ✓ Pre-Filter GNSS



Standard colors.
Other colors upon request.

General specification

Mounting type	Adhesive mount
Dimensions (mm)	Ø 77 × 12
Operating temperature	-40 °C to +85 °C

Antenna and electrical specifications

3G/2G/CELLULAR (Connection 1)

Standards	3G/Cellular/HSPA/UMTS/WCDA/ EDGE/EGPRS/GRPS/GSM/CDMA/2G
Frequency (MHz)	824-960, 1710-2170
VSWR	~1.6:1, ~2.4:1
Efficiency (%)	~43, ~32
Peak Gain (dBi)	~1.5, ~0.5
Impedance (Ohm)	50
Polarisation	Linear
Radiation Pattern	Omni-Directional
Max. Input Power (W)	25

Antenna and electrical specifications

GPS/GLONASS/QZSS/Galileo/L1 (Connection 2)

Standards	GPS(L1)/GLONASS(L1OF)/QZSS(L1)/Galileo(E1)
Frequency (MHz)	1575.42, 1598-1606
VSWR	<1.5:1
Impedance (Ohm)	50
Radiation Pattern	Hemispherical
Polarisation	RHCP
Active Gain (dB)	26 @ 3V
Voltage (V)	2.7 - 5.5
Current Consumption (mA)	15 - 25
Power Consumption (mW)	40.5 - 137.5
Saw Filter Type	Pre-Filter

2J4800PGF Active GNSS

3G/2G/CELLULAR &
GPS/GLONASS/QZSS/Galileo/L1

- Key Features** ✓ Ground Plane Independent ✓ Customizable Cable and Connector
✓ Certificates: IP67 - Water Resistant, IP69 - Hot Water Pressure ✓ Low Profile
✓ Pre-Filter GNSS ✓ Optional Antenna Detection Resistor



Standard colors.
Other colors upon request.

General specification

Mounting type	Adhesive mount
Dimensions (mm)	83 × 35 × 13.3
Operating temperature	-40 °C to +85 °C
Certificates	IP67, IP69

Antenna and electrical specifications

3G/2G/CELLULAR (Connection 1)

Standards	3G/Cellular/HSPA/UMTS/WCDA/ EDGE/EGPRS/GRPS/GSM/CDMA/2G
Frequency (MHz)	824-960, 1710-2170
VSWR	~1.4:1, ~1.3:1
Efficiency (%)	~57, ~49
Peak Gain (dBi)	~3.0, ~1.3
Impedance (Ohm)	50
Polarisation	Linear
Radiation Pattern	Omni-Directional
Max. Input Power (W)	25

Antenna and electrical specifications

GPS/GLONASS/QZSS/Galileo/L1 (Connection 2)

Standards	GPS(L1)/GLONASS(L1OF)/QZSS(L1)/Galileo(E1)
Frequency (MHz)	1575.42, 1598-1606
VSWR	<1.4:1
Impedance (Ohm)	50
Radiation Pattern	Hemispherical
Polarisation	RHCP
Active Gain (dB)	28 @ 2.7 V
Voltage (V)	1.5 - 3.6
Current Consumption (mA)	9 Typ
Power Consumption (mW)	24.3 Typ
Saw Filter Type	Pre-Filter
ESD Protection (kV)	2



2J4805P 3G/2G/CELLULAR & 2.4-5.0GHz/WiFi/LPWA/BT/ISM

- Key Features**
- ✔ Ground Plane Independent
 - ✔ Customizable Cable and Connector
 - ✔ Certificates: IP67 - Water Resistant, IP69 - Hot Water Pressure
 - ✔ Low Profile
 - ✔ Optional Antenna Detection Resistor



Standard colors.
Other colors upon request.

General specification

Mounting type	Adhesive mount
Dimensions (mm)	83 × 35 × 13.3
Operating temperature	-40 °C to +85 °C
Certificates	IP67, IP69

Antenna and electrical specifications

3G/2G/CELLULAR (Connection 1)

Standards	3G/Cellular/HSPA/UMTS/WCDMA/ EDGE/EGPRS/GRPS/GSM/CDMA/2G
Frequency (MHz)	824-960, 1710-2170
VSWR	~1.4:1, ~1.4:1
Efficiency (%)	~53, ~48
Peak Gain (dBi)	~2.1, ~1.1
Impedance (Ohm)	50
Polarisation	Linear
Radiation Pattern	Omni-Directional
Max. Input Power (W)	25

Antenna and electrical specifications

2.4-5.0GHz/WiFi/LPWA/BT/ISM (Connection 2)

Standards	WiFi/Sigfox/LoRa/LPWA/Bluetooth/ BLE/ZigBee/RFID/RFMA/ISM
Frequency (MHz)	2410-2490, 4920-5925
VSWR	~1.2:1, ~1.3:1
Efficiency (%)	~42, ~27
Peak Gain (dBi)	~2.5, ~0.5
Impedance (Ohm)	50
Polarisation	Linear
Radiation Pattern	Omni-Directional
Max. Input Power (W)	25

2J6033PGF Active GNSS GPS/GLONASS/QZSS/Galileo/L1 & IRIDIUM

- Key Features**
- ✔ High Performance
 - ✔ Low Profile
 - ✔ Ground Plane Independent
 - ✔ Customizable Cable and Connector
 - ✔ Pre-Filter GNSS

iridium certified antenna



Standard colors.
Other colors upon request.

General specification

Mounting type	Adhesive mount
Dimensions (mm)	80 × 76 × 16
Operating temperature	-40 °C to +85 °C

Antenna and electrical specifications

GPS/GLONASS/QZSS/Galileo/L1 (Connection 1)

Standards	GPS(L1)/GLONASS(L1OF)/QZSS(L1)/Galileo(E1)
Frequency (MHz)	1575.42, 1598-1606
VSWR	<1.4:1
Impedance (Ohm)	50
Radiation Pattern	Hemispherical
Polarisation	RHCP
Active Gain (dB)	28 @ 2.7 V
Voltage (V)	1.5 - 3.6
Current Consumption (mA)	9 Typ
Power Consumption (mW)	24.3 Typ
Saw Filter Type	Pre-Filter
ESD Protection (kV)	2

Antenna and electrical specifications

IRIDIUM (Connection 2)

Standards	IRIDIUM
Frequency (MHz)	1616-1627
VSWR	~1.2:1
Efficiency (%)	~76
Peak Gain (dBi)	~4.5
Impedance (Ohm)	50
Polarisation	RHCP
Radiation Pattern	Hemispherical
Axial Ratio (dB)	3 max.



2J6002Pa

2x 2.4-5.0GHz/WiFi/LPWA/BT/ISM

- Key Features**
- ✔ Low Profile
 - ✔ Ground Plane Independent
 - ✔ Customizable Cable and Connector

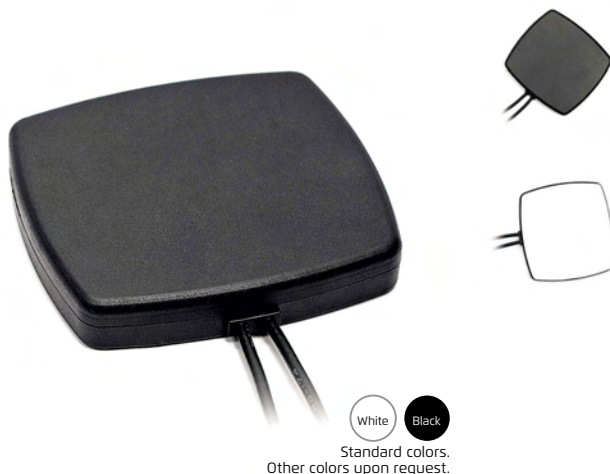

General specification

Mounting type	Adhesive mount
Dimensions (mm)	80 x 76 x 16
Operating temperature	-40 °C to +85 °C

Antenna and electrical specifications

2.4-5.0GHz/WiFi/LPWA/BT/ISM (Connection 1)

Standards	WiFi/Sigfox/LoRa/LPWA/Bluetooth/ BLE/ZigBee/RFID/RPMA/ISM
Frequency (MHz)	2410-2490, 4920-5925
VSWR	~1.4:1, ~1.5:1
Efficiency (%)	~61.6, ~44.6
Peak Gain (dBi)	~5.0, ~4.6
Impedance (Ohm)	50
Polarisation	Linear
Radiation Pattern	Omni-Directional
Max. Input Power (W)	10

Antenna and electrical specifications

2.4-5.0GHz/WiFi/LPWA/BT/ISM (Connection 2)

Standards	WiFi/Sigfox/LoRa/LPWA/Bluetooth/ BLE/ZigBee/RFID/RPMA/ISM
Frequency (MHz)	2410-2490, 4920-5925
VSWR	~1.4:1, ~1.5:1
Efficiency (%)	~60.1, ~41.2
Peak Gain (dBi)	~4.8, ~5.3
Impedance (Ohm)	50
Polarisation	Linear
Radiation Pattern	Omni-Directional
Max. Input Power (W)	10



2J6084PGFa 5G Antenna

2x 5G NR/4G LTE/FirstNet/CBRS/LPWA/3G/2G & GPS/GLONASS/QZSS/Galileo/L1

- Key Features**
- ✔ Low Profile
 - ✔ Ground Plane Independent
 - ✔ Customizable Cable and Connector
 - ✔ Pre-Filter GNSS

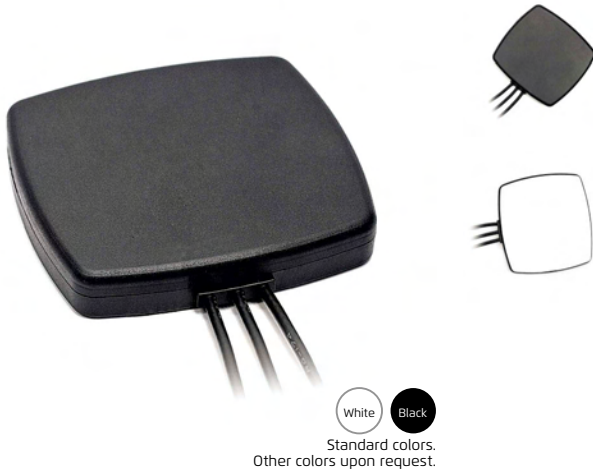

General specification

Mounting type	Adhesive mount
Dimensions (mm)	80 x 76 x 16
Operating temperature	-40 °C to +85 °C

Antenna and electrical specifications

5G NR/4G LTE/FirstNet/CBRS/LPWA/3G/2G (Connection 1)

Standards	5G NR/4G LTE/FirstNet/CBRS/LPWA/ CAT-X/CAT-Mx/CAT-NBx/NB-IoT/3G/2G
Frequency (MHz)	617-960, 1427-2690, 3300-5000, 5150-5925
Bands	see 5G Bands list on page 17
VSWR	~3.4:1, ~1.7:1, ~2.3:1, ~2.6:1
Efficiency (%)	~42.6, ~58.8, ~37.5, ~31.8
Peak Gain (dBi)	~2.4, ~4.4, ~2.0, ~1.1
Impedance (Ohm)	50
Polarisation	Linear
Radiation Pattern	Omni-Directional
Max. Input Power (W)	25

Antenna and electrical specifications

5G NR/4G LTE/FirstNet/CBRS/LPWA/3G/2G (Connection 2)

Standards	5G NR/4G LTE/FirstNet/CBRS/LPWA/ CAT-X/CAT-Mx/CAT-NBx/NB-IoT/3G/2G
Frequency (MHz)	617-960, 1427-2690, 3300-5000, 5150-5925
Bands	see 5G Bands list on page 17
VSWR	~3.5:1, ~1.6:1, ~2.3:1, ~2.3:1
Efficiency (%)	~43.9, ~63.9, ~36.8, ~31.1
Peak Gain (dBi)	~1.9, ~4.7, ~1.9, ~1.4
Impedance (Ohm)	50
Polarisation	Linear
Radiation Pattern	Omni-Directional
Max. Input Power (W)	25

Antenna and electrical specifications

GPS/GLONASS/QZSS/Galileo/L1 (Connection 3)

Standards	GPS(L1)/GLONASS(L1OF)/QZSS(L1)/Galileo(E1)
Frequency (MHz)	1575.42, 1598-1606
VSWR	<1.4:1
Impedance (Ohm)	50
Radiation Pattern	Hemispherical
Polarisation	RHCP
Active Gain (dB)	28 @ 2.7 V
Voltage (V)	1.5 - 3.6
Current Consumption (mA)	9 Typ
Power Consumption (mW)	24.3 Typ
Saw Filter Type	Pre-Filter
ESD Protection (kV)	2

2J6041PGFa Active GNSS

2x 4G LTE/FirstNet/LPWA/NB-IoT/3G/2G & GPS/GLONASS/QZSS/Galileo/L1

- Key Features**
- ✔ Low Profile
 - ✔ Ground Plane Independent
 - ✔ Customizable Cable and Connector
 - ✔ Pre-Filter GNSS

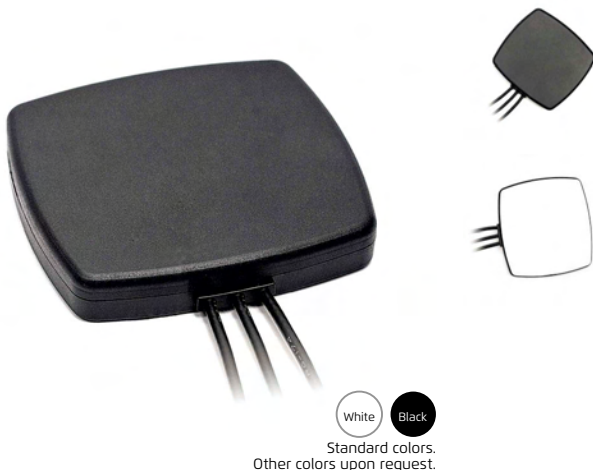

General specification

Mounting type	Adhesive mount
Dimensions (mm)	80 x 76 x 16
Operating temperature	-40 °C to +85 °C

Antenna and electrical specifications

4G LTE/FirstNet/LPWA/NB-IoT/3G/2G (Connection 1)

Standards	4G LTE/FirstNet/LPWA/ CAT-X/CAT-Mx/CAT-NBx/NB-IoT/3G/2G
Frequency (MHz)	698-960, 1710-2170, 2500-2700
VSWR	~2.2:1, ~1.2:1, ~2.2:1
Efficiency (%)	~55.6, ~56.0, ~38.7
Peak Gain (dBi)	~2.9, ~3.2, ~2.1
Impedance (Ohm)	50
Polarisation	Linear
Radiation Pattern	Omni-Directional
Max. Input Power (W)	25

Antenna and electrical specifications

4G LTE/FirstNet/LPWA/NB-IoT/3G/2G (Connection 2)

Standards	4G LTE/FirstNet/LPWA/ CAT-X/CAT-Mx/CAT-NBx/NB-IoT/3G/2G
Frequency (MHz)	698-960, 1710-2170, 2500-2700
VSWR	~2.3:1, ~1.2:1, ~2.0:1
Efficiency (%)	~50.5, ~53.9, ~41.2
Peak Gain (dBi)	~2.7, ~3.5, ~2.2
Impedance (Ohm)	50
Polarisation	Linear
Radiation Pattern	Omni-Directional
Max. Input Power (W)	25

Antenna and electrical specifications

GPS/GLONASS/QZSS/Galileo/L1 (Connection 3)

Standards	GPS(L1)/GLONASS(L1OF)/QZSS(L1)/Galileo(E1)
Frequency (MHz)	1575.42, 1598-1606
VSWR	<1.4:1
Impedance (Ohm)	50
Radiation Pattern	Hemispherical
Polarisation	RHCP
Active Gain (dB)	28 @ 2.7 V
Voltage (V)	1.5 - 3.6
Current Consumption (mA)	9 Typ
Power Consumption (mW)	24.3 Typ
Saw Filter Type	Pre-Filter
ESD Protection (kV)	2



2J4A41PCFa Active GNSS 2x 4G LTE/FirstNet/LPWA/NB-IoT/3G/2G & GPS/GLONASS/BEIDOU/QZSS/Galileo/L1

- Key Features**
- High Performance
 - Ground Plane Independent
 - Certificates: IP67 - Water Resistant, IP69 - Hot Water Pressure
 - Customizable Cable and Connector
 - Low Profile
 - Pre-Filter GNSS

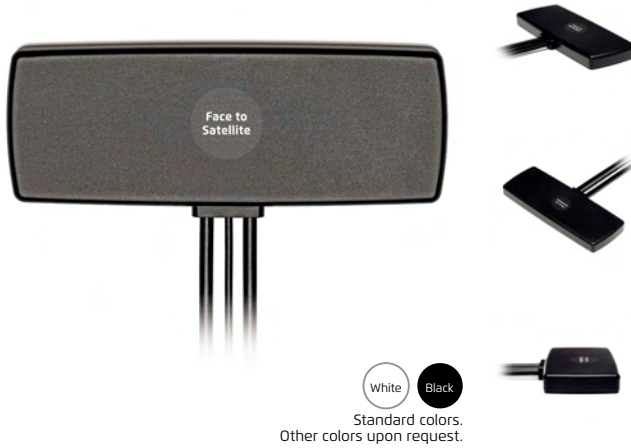

Standard colors.
Other colors upon request.

General specification

Mounting type	Adhesive mount
Dimensions (mm)	61.8 × 155.6 × 17.0
Operating temperature	-40 °C to +85 °C
Certificates	IP67, IP69

Antenna and electrical specifications

4G LTE/FirstNet/LPWA/NB-IoT/3G/2G (Connection 1)

Standards	4G LTE/FirstNet/LPWA/ CAT-X/CAT-Mx/CAT-NBx/NB-IoT/3G/2G
Frequency (MHz)	698-960, 1710-2170, 2500-2700
VSWR	~1.7:1, ~1.3:1, ~1.9:1
Efficiency (%)	~52.9, ~63.2, ~43.7
Peak Gain (dBi)	~2.2, ~3.6, ~2.9
Impedance (Ohm)	50
Polarisation	Linear
Radiation Pattern	Omni-Directional
Max. Input Power (W)	25

Antenna and electrical specifications

4G LTE/FirstNet/LPWA/NB-IoT/3G/2G (Connection 2)

Standards	4G LTE/FirstNet/LPWA/ CAT-X/CAT-Mx/CAT-NBx/NB-IoT/3G/2G
Frequency (MHz)	698-960, 1710-2170, 2500-2700
VSWR	~2.1:1, ~1.5:1, ~2.0:1
Efficiency (%)	~45.3, ~58.9, ~41.2
Peak Gain (dBi)	~1.1, ~4.4, ~2.2
Impedance (Ohm)	50
Polarisation	Linear
Radiation Pattern	Omni-Directional
Max. Input Power (W)	25

Antenna and electrical specifications

GPS/GLONASS/BEIDOU/QZSS/Galileo/L1 (Connection 3)

Standards	GPS(L1)/GLONASS(L10F)/BeiDou(B1)/ QZSS(L1)/Galileo(E1)
Frequency (MHz)	1561.098, 1575.42, 1598-1606
VSWR	<1.4:1
Impedance (Ohm)	50
Radiation Pattern	Hemispherical
Polarisation	RHCP
Active Gain (dB)	28 @ 2.7 V
Voltage (V)	1.5 - 3.6
Current Consumption (mA)	9 Typ
Power Consumption (mW)	24.3 Typ
Saw Filter Type	Pre-Filter

2J6050PGF Active GNSS 4G LTE/FirstNet/LPWA/NB-IoT/3G/2G & GPS/GLONASS/QZSS/Galileo/L1 & 2.4-5.0GHz/WiFi/LPWA/BT/ISM

- Key Features**
- Low Profile
 - Ground Plane Independent
 - Customizable Cable and Connector
 - Pre-Filter GNSS

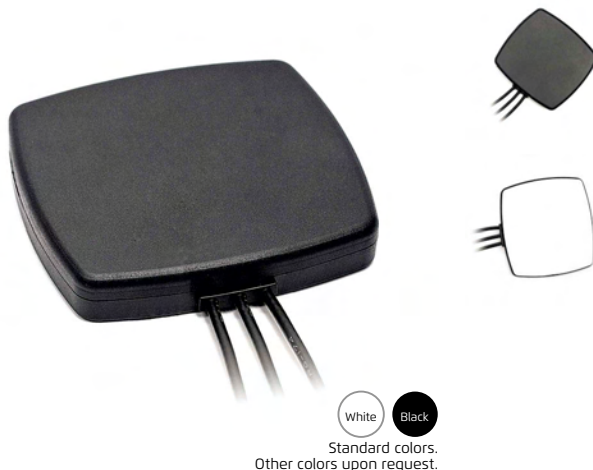

Standard colors.
Other colors upon request.

General specification

Mounting type	Adhesive mount
Dimensions (mm)	80 × 76 × 16
Operating temperature	-40 °C to +85 °C

Antenna and electrical specifications

4G LTE/FirstNet/LPWA/NB-IoT/3G/2G (Connection 1)

Standards	4G LTE/FirstNet/LPWA/ CAT-X/CAT-Mx/CAT-NBx/NB-IoT/3G/2G
Frequency (MHz)	698-960, 1710-2170, 2500-2700
VSWR	~2.2:1, ~1.2:1, ~2.2:1
Efficiency (%)	~55.6, ~56.0, ~38.7
Peak Gain (dBi)	~2.9, ~3.2, ~2.1
Impedance (Ohm)	50
Polarisation	Linear
Radiation Pattern	Omni-Directional
Max. Input Power (W)	25

Antenna and electrical specifications

GPS/GLONASS/QZSS/Galileo/L1 (Connection 2)

Standards	GPS(L1)/GLONASS(L10F)/QZSS(L1)/Galileo(E1)
Frequency (MHz)	1575.42, 1598-1606
VSWR	<1.4:1
Impedance (Ohm)	50
Radiation Pattern	Hemispherical
Polarisation	RHCP
Active Gain (dB)	28 @ 2.7 V
Voltage (V)	1.5 - 3.6
Current Consumption (mA)	9 Typ
Power Consumption (mW)	24.3 Typ
Saw Filter Type	Pre-Filter
ESD Protection (kV)	2

Antenna and electrical specifications

2.4-5.0GHz/WiFi/LPWA/BT/ISM (Connection 3)

Standards	WiFi/Sigfox/LoRa/LPWA/Bluetooth/ BLE/ZigBee/RFID/RFMA/ISM
Frequency (MHz)	2410-2490, 4920-5925
VSWR	~1.3:1, ~1.3:1
Efficiency (%)	~50, ~30
Peak Gain (dBi)	~3.2, ~4.2
Impedance (Ohm)	50
Polarisation	Linear
Radiation Pattern	Omni-Directional
Max. Input Power (W)	25



2J4950PGF Active GNSS 4G LTE/FirstNet/LPWA/NB-IoT/3G/2G & GPS/GLONASS/QZSS/Galileo/L1 & 2.4-5.0GHz/WiFi/LPWA/BT/ISM

- Key Features**
- ✔ Ground Plane Independent
 - ✔ Customizable Cable and Connector
 - ✔ Certificates: IP67 - Water Resistant, IP69 - Hot Water Pressure
 - ✔ High Performance
 - ✔ Pre-Filter GNSS

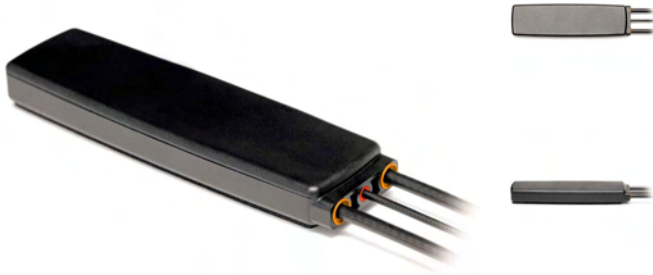

Standard colors.
Other colors upon request.

General specification

Mounting type	Adhesive mount
Dimensions (mm)	150.5 × 42 × 15.3
Operating temperature	-40 °C to +85 °C
Certificates	IP67, IP69

Antenna and electrical specifications

4G LTE/FirstNet/LPWA/NB-IoT/3G/2G (Connection 1)

Standards	4G LTE/FirstNet/LPWA/ CAT-X/CAT-Mx/CAT-NBx/NB-IoT/3G/2G
Frequency (MHz)	698-960, 1710-2170, 2500-2700
VSWR	~1.6:1, ~1.3:1, ~1.5:1
Efficiency (%)	~72, ~67, ~65
Peak Gain (dBi)	~5.1, ~5.0, ~4.2
Impedance (Ohm)	50
Polarisation	Linear
Radiation Pattern	Omni-Directional
Max. Input Power (W)	25

Antenna and electrical specifications

GPS/GLONASS/QZSS/Galileo/L1 (Connection 2)

Standards	GPS(L1)/GLONASS(L10F)/QZSS(L1)/Galileo(E1)
Frequency (MHz)	1575.42, 1598-1606
VSWR	<1.4:1
Impedance (Ohm)	50
Radiation Pattern	Hemispherical
Polarisation	RHCP
Active Gain (dB)	28 @ 2.7 V
Voltage (V)	1.5 - 3.6
Current Consumption (mA)	9 Typ
Power Consumption (mW)	24.3 Typ
Saw Filter Type	Pre-Filter
ESD Protection (kV)	2

Antenna and electrical specifications

2.4-5.0GHz/WiFi/LPWA/BT/ISM (Connection 3)

Standards	WiFi/Sigfox/LoRa/LPWA/Bluetooth/ BLE/ZigBee/RFID/RFMA/ISM
Frequency (MHz)	2410-2490, 4920-5925
VSWR	~1.3:1, ~1.6:1
Efficiency (%)	~54, ~64
Peak Gain (dBi)	~5.8, ~6.3
Impedance (Ohm)	50
Polarisation	Linear
Radiation Pattern	Omni-Directional
Max. Input Power (W)	25

2J4A50PCF Active GNSS 4G LTE/FirstNet/LPWA/NB-IoT/3G/2G & GPS/GLONASS/BEIDOU/QZSS/Galileo/L1 & 2.4-5.0GHz/WiFi/LPWA/BT/ISM

- Key Features**
- ✔ High Performance
 - ✔ Ground Plane Independent
 - ✔ Certificates: IP67 - Water Resistant, IP69 - Hot Water Pressure
 - ✔ Customizable Cable and Connector
 - ✔ Low Profile
 - ✔ Pre-Filter GNSS



Standard colors.
Other colors upon request.

General specification

Mounting type	Adhesive mount
Dimensions (mm)	61.8 × 155.6 × 17.0
Operating temperature	-40 °C to +85 °C
Certificates	IP67, IP69

Antenna and electrical specifications

4G LTE/FirstNet/LPWA/NB-IoT/3G/2G (Connection 1)

Standards	4G LTE/FirstNet/LPWA/ CAT-X/CAT-Mx/CAT-NBx/NB-IoT/3G/2G
Frequency (MHz)	698-960, 1710-2170, 2500-2700
VSWR	~1.7:1, ~1.3:1, ~2.0:1
Efficiency (%)	~64.3, ~64.9, ~49.9
Peak Gain (dBi)	~2.4, ~3.9, ~1.9
Impedance (Ohm)	50
Polarisation	Linear
Radiation Pattern	Omni-Directional
Max. Input Power (W)	25

Antenna and electrical specifications

GPS/GLONASS/BEIDOU/QZSS/Galileo/L1 (Connection 3)

Standards	GPS(L1)/GLONASS(L10F)/BeiDou(B1)/ QZSS(L1)/Galileo(E1)
Frequency (MHz)	1561.098, 1575.42, 1598-1606
VSWR	<1.4:1
Impedance (Ohm)	50
Radiation Pattern	Hemispherical
Polarisation	RHCP
Active Gain (dB)	28 @ 2.7 V
Voltage (V)	1.5 - 3.6
Current Consumption (mA)	9 Typ
Power Consumption (mW)	24.3 Typ
Saw Filter Type	Pre-Filter

Antenna and electrical specifications

2.4-5.0GHz/WiFi/LPWA/BT/ISM (Connection 3)

Standards	WiFi/Sigfox/LoRa/LPWA/Bluetooth/ BLE/ZigBee/RFID/RFMA/ISM
Frequency (MHz)	2410-2490, 4920-5925
VSWR	~1.9:1, ~1.9:1
Efficiency (%)	~46.7, ~36.0
Peak Gain (dBi)	~2.4, ~2.5
Impedance (Ohm)	50
Polarisation	Linear
Radiation Pattern	Omni-Directional
Max. Input Power (W)	25



2J4A50PCFc Active GNSS

2x 4GLTE/FirstNet/LPWA/NB-IoT/3G/2G & GPS/GLONASS/BEIDOU/QZSS/Galileo/L1 & 2.4-5.0GHz/WiFi/LPWA/BT/ISM

- Key Features**
- ✔ High Performance
 - ✔ Ground Plane Independent
 - ✔ Certificates: IP67 - Water Resistant, IP69 - Hot Water Pressure
 - ✔ Customizable Cable and Connector
 - ✔ Low Profile
 - ✔ Pre-Filter GNSS



Standard colors.
Other colors upon request.



Antenna and electrical specifications

GPS/GLONASS/BEIDOU/QZSS/Galileo/L1 (Connection 3)

Standards	GPS(L1)/GLONASS(L10F)/BeiDou(B1)/QZSS(L1)/Galileo(E1)
Frequency (MHz)	1561.098, 1575.42, 1598-1606
VSWR	<1.4:1
Impedance (Ohm)	50
Radiation Pattern	Hemispherical
Polarisation	RHCP
Active Gain (dB)	28 @ 2.7 V
Voltage (V)	1.5 - 3.6
Current Consumption (mA)	9 Typ
Power Consumption (mW)	24.3 Typ
Saw Filter Type	Pre-Filter

General specification

Mounting type	Adhesive mount
Dimensions (mm)	61.8 × 155.6 × 17.0
Operating temperature	-40 °C to +85 °C
Certificates	IP67, IP69

Antenna and electrical specifications

4GLTE/FirstNet/LPWA/NB-IoT/3G/2G (Connection 1)

Standards	4GLTE/FirstNet/LPWA/CAT-X/CAT-Mx/CAT-NBx/NB-IoT/3G/2G
Frequency (MHz)	698-960, 1710-2170, 2500-2700
VSWR	~2.0:1, ~1.6:1, ~1.3:1
Efficiency (%)	~45.0, ~51.4, ~41.0
Peak Gain (dBi)	~0.9, ~3.8, ~3.0
Impedance (Ohm)	50
Polarisation	Linear
Radiation Pattern	Omni-Directional
Max. Input Power (W)	25

Antenna and electrical specifications

4GLTE/FirstNet/LPWA/NB-IoT/3G/2G (Connection 2)

Standards	4GLTE/FirstNet/LPWA/CAT-X/CAT-Mx/CAT-NBx/NB-IoT/3G/2G
Frequency (MHz)	698-960, 1710-2170, 2500-2700
VSWR	~1.7:1, ~1.3:1, ~2.1:1
Efficiency (%)	~50.1, ~59.5, ~40.4
Peak Gain (dBi)	~2.2, ~4.0, ~1.3
Impedance (Ohm)	50
Polarisation	Linear
Radiation Pattern	Omni-Directional
Max. Input Power (W)	25

Antenna and electrical specifications

2.4-5.0GHz/WiFi/LPWA/BT/ISM (Connection 4)

Standards	WiFi/Sigfox/LoRa/LPWA/Bluetooth/BLE/ZigBee/RFID/RPMA/ISM
Frequency (MHz)	2410-2490, 4920-5925
VSWR	~1.5:1, ~1.5:1
Efficiency (%)	~45.1, ~43.2
Peak Gain (dBi)	~2.8, ~3.4
Impedance (Ohm)	50
Polarisation	Linear
Radiation Pattern	Omni-Directional
Max. Input Power (W)	25



2J4A47Pc

**2x 4GLTE/FirstNet/LPWA/NB-IoT/3G/2G &
2x 2.4-5.0GHz/WiFi/LPWA/BT/ISM**

- Key Features**
- ✔ High Performance
 - ✔ Ground Plane Independent
 - ✔ Certificates: IP67 - Water Resistant, IP69 - Hot Water Pressure
 - ✔ Customizable Cable and Connector
 - ✔ Low Profile

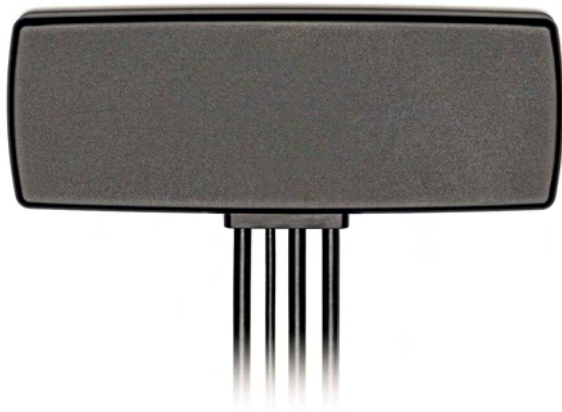

Standard colors.
Other colors upon request.



General specification

Mounting type	Adhesive mount
Dimensions (mm)	61.8 × 155.6 × 17.0
Operating temperature	-40 °C to +85 °C
Certificates	IP67, IP69

Antenna and electrical specifications

4GLTE/FirstNet/LPWA/NB-IoT/3G/2G (Connection 1)

Standards	4GLTE/FirstNet/LPWA/ CAT-X/CAT-Mx/CAT-NBx/NB-IoT/3G/2G
Frequency (MHz)	698-960, 1710-2170, 2500-2700
VSWR	~1.8:1, ~1.3:1, ~2.0:1
Efficiency (%)	~49.6, ~52.6, ~39.1
Peak Gain (dBi)	~2.0, ~2.7, ~2.0
Impedance (Ohm)	50
Polarisation	Linear
Radiation Pattern	Omni-Directional
Max. Input Power (W)	25

Antenna and electrical specifications

4GLTE/FirstNet/LPWA/NB-IoT/3G/2G (Connection 2)

Standards	4GLTE/FirstNet/LPWA/ CAT-X/CAT-Mx/CAT-NBx/NB-IoT/3G/2G
Frequency (MHz)	698-960, 1710-2170, 2500-2700
VSWR	~2.0:1, ~1.5:1, ~1.3:1
Efficiency (%)	~47.4, ~50.4, ~41.2
Peak Gain (dBi)	~1.7, ~4.0, ~3.1
Impedance (Ohm)	50
Polarisation	Linear
Radiation Pattern	Omni-Directional
Max. Input Power (W)	25

Antenna and electrical specifications

2.4-5.0GHz/WiFi/LPWA/BT/ISM (Connection 3)

Standards	WiFi/Sigfox/LoRa/LPWA/Bluetooth/ BLE/ZigBee/RFID/RPMA/ISM
Frequency (MHz)	2410-2490, 4920-5925
VSWR	~1.1:1, ~1.6:1
Efficiency (%)	~45.3, ~40.2
Peak Gain (dBi)	~3.0, ~3.5
Impedance (Ohm)	50
Polarisation	Linear
Radiation Pattern	Omni-Directional
Max. Input Power (W)	25

Antenna and electrical specifications

2.4-5.0GHz/WiFi/LPWA/BT/ISM (Connection 4)

Standards	WiFi/Sigfox/LoRa/LPWA/Bluetooth/ BLE/ZigBee/RFID/RPMA/ISM
Frequency (MHz)	2410-2490, 4920-5925
VSWR	~1.2:1, ~1.5:1
Efficiency (%)	~46.6, ~44.5
Peak Gain (dBi)	~3.7, ~3.6
Impedance (Ohm)	50
Polarisation	Linear
Radiation Pattern	Omni-Directional
Max. Input Power (W)	25

2J4A50PCFa Antenna

5-in-1 Antenna



2× 4GLTE/FirstNet/LPWA/NB-IoT/Cat-X-Mx-NBx/3G/2G

2× 2.4-5.0GHz/WiFi/Sigfox/LoRa/LPWA/BT/ZigBee/RFID/ISM

GPS/GLONASS/BeiDou/QZSS/Galileo/L1

A stellar performance in a compact system

With a size reduction of up to 50% in comparison with other antennas in the market and the highest performance for a 5-in-1 antenna solution, single package the Condor 2J4A50PCFa antenna is the most competitive solution on the market. Users can opt for other configurations in the same enclosure such as 2-in-1, 3-in-1 or 4-in-1 antenna as per their needs, please check our website or contact our sales team for questions and details.

If you are looking for an antenna that is sleek in design and makes no compromises on efficiency and performance, then 2J4A50PCFa is the best option. Engineered according to the latest technological advancements, this antenna provides LTE-MIMO (2x), 2.4/5.0GHz-MIMO (2x) and GNSS (1x) applications delivering very high-efficiency uninterrupted data transfers at maximum speed, achieved by the low Envelope Correlation Coefficient at the LTE-MIMO and WIFI-MIMO Antennas.

Worldwide solution

The key feature here is that 2J4A50PCFa is compatible with all LTE, 4G, 3G or 2G network ecosystems. With countless applications and customer-centric benefits, high-precision, low noise and low power consumption GNSS active ceramic antenna stands out among its competition, compatible for GPS, Glonass, BeiDou, Galileo and QZSS geolocation technologies. Dual high gain WiFi antennas are included in the package for all channels and standards in the 2.4 and 5.0GHz bands.

Installation and Durability

The 2J4A50PCFa can be easily installed or hidden in any part of your environment and application; on the top or bottom surfaces including windshields, dash, plastic, etc., as it comes equipped with a separate double adhesive pad that secures it safely. This product includes a low loss double shielded cable with fully customized length and connector that provides maximum antenna performance and reliability, avoiding drop connections, higher speed data, higher gain, etc. 5-in-1 feature allows for a quick handling in places where other solutions fail to implement and eliminates the need for the extensive labor involved in the installation of the product, saving time and resources.

Not only does this technology assure smooth performance, but it also comes bearing safety guarantee. With IP67 and IP69 ingress rating, our product provides maximum protection against dust and water and allows high pressure and steam cleaning. Passing drop test and vibration provides extra robustness ensuring longevity of the product, making it a cost-effective solution.



2J4A50PCFa Active GNSS

2x 4GLTE/FirstNet/LPWA/NB-IoT/3G/2G &
2x 2.4-5.0GHz/WiFi/LPWA/BT/ISM &
GPS/GLONASS/BEIDOU/QZSS/Galileo/L1

- Key Features**
- ✔ High Performance
 - ✔ Ground Plane Independent
 - ✔ Certificates: IP67 - Water Resistant, IP69 - Hot Water Pressure
 - ✔ Customizable Cable and Connector
 - ✔ Low Profile
 - ✔ Pre-Filter GNSS



White Black
 Standard colors.
 Other colors upon request.



Antenna and electrical specifications

2.4-5.0GHz/WiFi/LPWA/BT/ISM (Connection 4)

Standards	WiFi/Sigfox/LoRa/LPWA/Bluetooth/ BLE/ZigBee/RFID/ RPMA/ISM
Frequency (MHz)	2410-2490, 4920-5925
VSWR	~1.2:1, ~1.5:1
Efficiency (%)	~46.6, ~44.5
Peak Gain (dBi)	~3.7, ~3.6
Impedance (Ohm)	50
Polarisation	Linear
Radiation Pattern	Omni-Directional
Max. Input Power (W)	25

General specification

Mounting type	Adhesive mount
Dimensions (mm)	61.8 x 155.6 x 17.0
Operating temperature	-40 °C to +85 °C
Certificates	IP67, IP69

Antenna and electrical specifications

4GLTE/FirstNet/LPWA/NB-IoT/3G/2G (Connection 1)

Standards	4GLTE/FirstNet/LPWA/ CAT-X/CAT-Mx/CAT-NBx/NB-IoT/3G/2G
Frequency (MHz)	698-960, 1710-2170, 2500-2700
VSWR	~1.8:1, ~1.3:1, ~2.0:1
Efficiency (%)	~49.6, ~52.6, ~39.1
Peak Gain (dBi)	~2.0, ~2.7, ~2.0
Impedance (Ohm)	50
Polarisation	Linear
Radiation Pattern	Omni-Directional
Max. Input Power (W)	25

Antenna and electrical specifications

4GLTE/FirstNet/LPWA/NB-IoT/3G/2G (Connection 2)

Standards	4GLTE/FirstNet/LPWA/ CAT-X/CAT-Mx/CAT-NBx/NB-IoT/3G/2G
Frequency (MHz)	698-960, 1710-2170, 2500-2700
VSWR	~2.0:1, ~1.5:1, ~1.3:1
Efficiency (%)	~47.4, ~50.4, ~41.2
Peak Gain (dBi)	~1.7, ~4.0, ~3.1
Impedance (Ohm)	50
Polarisation	Linear
Radiation Pattern	Omni-Directional
Max. Input Power (W)	25

Antenna and electrical specifications

2.4-5.0GHz/WiFi/LPWA/BT/ISM (Connection 3)

Standards	WiFi/Sigfox/LoRa/LPWA/Bluetooth/ BLE/ZigBee/RFID/ RPMA/ISM
Frequency (MHz)	2410-2490, 4920-5925
VSWR	~1.1:1, ~1.6:1
Efficiency (%)	~45.3, ~40.2
Peak Gain (dBi)	~3.0, ~3.5
Impedance (Ohm)	50
Polarisation	Linear
Radiation Pattern	Omni-Directional
Max. Input Power (W)	25

Antenna and electrical specifications

GPS/GLONASS/BEIDOU/QZSS/Galileo/L1 (Connection 3)

Standards	GPS(L1)/GLONASS(L10F)/BeiDou(B1)/ QZSS(L1)/Galileo(E1)
Frequency (MHz)	1561.098, 1575.42, 1598-1606
VSWR	<1.4:1
Impedance (Ohm)	50
Radiation Pattern	Hemispherical
Polarisation	RHCP
Active Gain (dB)	28 @ 2.7 V
Voltage (V)	1.5 - 3.6
Current Consumption (mA)	9 Typ
Power Consumption (mW)	24.3 Typ
Saw Filter Type	Pre-Filter



2J6024Ma

2x 4GLTE/FirstNet/LPWA/NB-IoT/3G/2G

- Key Features**
- ✔ Low Profile
 - ✔ Ground Plane Independent
 - ✔ Customizable Cable and Connector

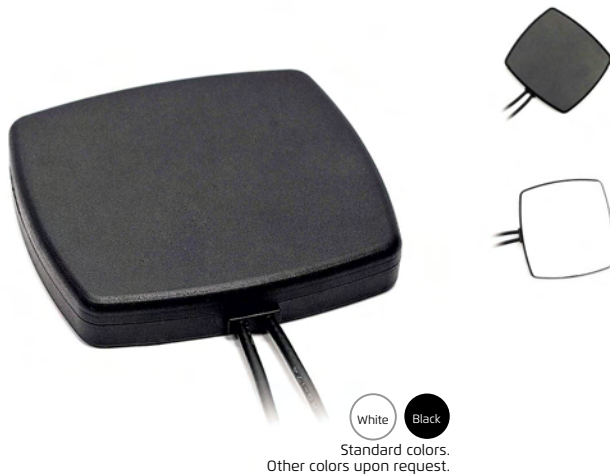

General specification

Mounting type	Magnetic mount
Dimensions (mm)	80 × 76 × 13
Operating temperature	-40 °C to +85 °C

Antenna and electrical specifications

4GLTE/FirstNet/LPWA/NB-IoT/3G/2G (Connection 1)

Standards	4GLTE/FirstNet/LPWA/ CAT-X/CAT-Mx/CAT-NBx/NB-IoT/3G/2G
Frequency (MHz)	698-960, 1710-2170, 2500-2700
VSWR	~2.2:1, ~2.6:1, ~2.1:1
Efficiency (%)	~25.3, ~20.2, ~36.1
Peak Gain (dBi)	~-0.7, ~1.7, ~4.4
Impedance (Ohm)	50
Polarisation	Linear
Radiation Pattern	Omni-Directional
Max. Input Power (W)	25

Antenna and electrical specifications

4GLTE/FirstNet/LPWA/NB-IoT/3G/2G (Connection 2)

Standards	4GLTE/FirstNet/LPWA/ CAT-X/CAT-Mx/CAT-NBx/NB-IoT/3G/2G
Frequency (MHz)	698-960, 1710-2170, 2500-2700
VSWR	~2.5:1, ~2.5:1, ~2.2:1
Efficiency (%)	~25.7, ~22.5, ~35.2
Peak Gain (dBi)	~-0.8, ~1.8, ~4.5
Impedance (Ohm)	50
Polarisation	Linear
Radiation Pattern	Omni-Directional
Max. Input Power (W)	25

2J6524Ma for EU LTE only

2x 4GLTE/FirstNet/LPWA/NB-IoT/3G/2G

- Key Features**
- ✔ Ground Plane Dependent
 - ✔ Customizable Cable and Connector
 - ✔ Certificates: IP67 - Water Resistant, IP69 - Hot Water Pressure, IK09 - Impact Resistant



General specification

Mounting type	Magnetic mount
Dimensions (mm)	∅ 135.5 × 30.0
Operating temperature	-40 °C to +85 °C
Certificates	IP67, IP69, IK09

Antenna and electrical specifications

4GLTE/FirstNet/LPWA/NB-IoT/3G/2G (Connection 1)

Standards	4GLTE/FirstNet/LPWA/ CAT-X/CAT-Mx/CAT-NBx/NB-IoT/3G/2G
Frequency (MHz)	791-960, 1710-2170, 2500-2700
VSWR	~3.4:1, ~1.8:1, ~2.7:1
Efficiency (%)	~40.6, ~53.2, ~32.1
Peak Gain (dBi)	~1.5, ~4.0, ~1.7
Impedance (Ohm)	50
Polarisation	Linear
Radiation Pattern	Omni-Directional
Max. Input Power (W)	25

Antenna and electrical specifications

4GLTE/FirstNet/LPWA/NB-IoT/3G/2G (Connection 2)

Standards	4GLTE/FirstNet/LPWA/ CAT-X/CAT-Mx/CAT-NBx/NB-IoT/3G/2G
Frequency (MHz)	791-960, 1710-2170, 2500-2700
VSWR	~2.7:1, ~1.6:1, ~1.9:1
Efficiency (%)	~32.5, ~41.5, ~26.6
Peak Gain (dBi)	~-0.7, ~2.7, ~1.2
Impedance (Ohm)	50
Polarisation	Linear
Radiation Pattern	Omni-Directional
Max. Input Power (W)	25



2J7724Ma

2x 4GLTE/FirstNet/LPWA/NB-IoT/3G/2G

- Key Features**
- High Performance
 - Ground Plane Dependent
 - Certificates: IP67 - Water Resistant, IP69 - Hot Water Pressure, IK09 - Impact Resistant
 - Customizable Cable and Connector



Standard colors.
Other colors upon request.



General specification

Mounting type	Magnetic mount
Dimensions (mm)	Ø 54 × 68.2
Operating temperature	-40 °C to +85 °C
Certificates	IP67, IP69, IK09

Antenna and electrical specifications

4GLTE/FirstNet/LPWA/NB-IoT/3G/2G (Connection 1)

Standards	4GLTE/FirstNet/LPWA/ CAT-X/CAT-Mx/CAT-NBx/NB-IoT/3G/2G
Frequency (MHz)	698-960, 1710-2170, 2500-2700
VSWR	~2.7:1, ~1.5:1, ~1.4:1
Efficiency (%)	~39, ~52, ~50
Peak Gain (dBi)	~-0.1, ~2.9, ~3.5
Impedance (Ohm)	50
Polarisation	Linear
Radiation Pattern	Omni-Directional
Max. Input Power (W)	25

Antenna and electrical specifications

4GLTE/FirstNet/LPWA/NB-IoT/3G/2G (Connection 2)

Standards	4GLTE/FirstNet/LPWA/ CAT-X/CAT-Mx/CAT-NBx/NB-IoT/3G/2G
Frequency (MHz)	698-960, 1710-2170, 2500-2700
VSWR	~2.7:1, ~1.5:1, ~1.5:1
Efficiency (%)	~38, ~52, ~53
Peak Gain (dBi)	~-0.1, ~3.1, ~2.7
Impedance (Ohm)	50
Polarisation	Linear
Radiation Pattern	Omni-Directional
Max. Input Power (W)	25

2J6041MGF Active GNSS

4GLTE/FirstNet/LPWA/NB-IoT/3G/2G & GPS/GLONASS/QZSS/Galileo/L1

- Key Features**
- Low Profile
 - Ground Plane Dependent
 - Customizable Cable and Connector
 - Pre-Filter GNSS



Standard colors.
Other colors upon request.



General specification

Mounting type	Magnetic mount
Dimensions (mm)	80 × 76 × 13
Operating temperature	-40 °C to +85 °C

Antenna and electrical specifications

4GLTE/FirstNet/LPWA/NB-IoT/3G/2G (Connection 1)

Standards	4GLTE/FirstNet/LPWA/ CAT-X/CAT-Mx/CAT-NBx/NB-IoT/3G/2G
Frequency (MHz)	698-960, 1710-2170, 2500-2700
VSWR	~2.0:1, ~2.3:1, ~1.6:1
Efficiency (%)	~51.1, ~27.9, ~43.6
Peak Gain (dBi)	~2.8, ~2.6, ~4.3
Impedance (Ohm)	50
Polarisation	Linear
Radiation Pattern	Omni-Directional
Max. Input Power (W)	25

Antenna and electrical specifications

GPS/GLONASS/QZSS/Galileo/L1 (Connection 2)

Standards	GPS(L1)/GLONASS(L1OF)/QZSS(L1)/Galileo(E1)
Frequency (MHz)	1575.42, 1598-1606
VSWR	<1.4:1
Impedance (Ohm)	50
Radiation Pattern	Hemispherical
Polarisation	RHCP
Active Gain (dB)	28 @ 2.7 V
Voltage (V)	1.5 - 3.6
Current Consumption (mA)	9 Typ
Power Consumption (mW)	24.3 Typ
Saw Filter Type	Pre-Filter
ESD Protection (kV)	2



2J7541MG Active GNSS 4GLTE/FirstNet/LPWA/NB-IoT/3G/2G & GPS/GLONASS/QZSS/Galileo/L1

- Key Features**
- High Performance
 - Ground Plane Dependent
 - Certificates: IP67 - Water Resistant
 - Customizable Cable and Connector
 - Pre-Filter GNSS



White Black
Standard colors.
Other colors upon request.

General specification

Mounting type	Magnetic mount
Dimensions (mm)	Ø 54 × 80
Operating temperature	-40 °C to +85 °C
Certificates	IP67

Antenna and electrical specifications

4GLTE/FirstNet/LPWA/NB-IoT/3G/2G (Connection 1)

Standards	4GLTE/FirstNet/LPWA/ CAT-X/CAT-Mx/CAT-NBx/NB-IoT/3G/2G
Frequency (MHz)	698-960, 1710-2170, 2500-2700
VSWR	~2.1:1, ~1.6:1, ~1.5:1
Efficiency (%)	~57, ~53, ~46
Peak Gain (dBi)	~1.3, ~2.0, ~2.6
Impedance (Ohm)	50
Polarisation	Linear
Radiation Pattern	Omni-Directional
Max. Input Power (W)	25

Antenna and electrical specifications

GPS/GLONASS/QZSS/Galileo/L1 (Connection 2)

Standards	GPS(L1)/GLONASS(L10F)/QZSS(L1)/Galileo(E1)
Frequency (MHz)	1575.42, 1598-1606
VSWR	<1.2:1
Impedance (Ohm)	50
Radiation Pattern	Hemispherical
Polarisation	RHCP
Active Gain (dB)	26 @ 3V / 27dB @ 5V
Voltage (V)	2.7 - 5.5
Current Consumption (mA)	15 - 25
Power Consumption (mW)	40.5 - 137.5
Saw Filter Type	No Filter

2J7741MGF Active GNSS 4GLTE/FirstNet/LPWA/NB-IoT/3G/2G & GPS/GLONASS/QZSS/Galileo/L1

- Key Features**
- High Performance
 - Ground Plane Dependent
 - Certificates: IP67 - Water Resistant, IP69 - Hot Water Pressure, IK09 - Impact Resistant
 - Customizable Cable and Connector
 - Pre-Filter GNSS



White Black
Standard colors.
Other colors upon request.



General specification

Mounting type	Magnetic mount
Dimensions (mm)	Ø 54 × 68.2
Operating temperature	-40 °C to +85 °C
Certificates	IP67, IP69, IK09

Antenna and electrical specifications

4GLTE/FirstNet/LPWA/NB-IoT/3G/2G (Connection 1)

Standards	4GLTE/FirstNet/LPWA/ CAT-X/CAT-Mx/CAT-NBx/NB-IoT/3G/2G
Frequency (MHz)	698-960, 1710-2170, 2500-2700
VSWR	~1.9:1, ~1.2:1, ~1.4:1
Efficiency (%)	~60.1, ~68, ~56.4
Peak Gain (dBi)	~1.8, ~3.1, ~2.9
Impedance (Ohm)	50
Polarisation	Linear
Radiation Pattern	Omni-Directional
Max. Input Power (W)	25

Antenna and electrical specifications

GPS/GLONASS/QZSS/Galileo/L1 (Connection 2)

Standards	GPS(L1)/GLONASS(L10F)/QZSS(L1)/Galileo(E1)
Frequency (MHz)	1575.42, 1598-1606
VSWR	<1.4:1
Impedance (Ohm)	50
Radiation Pattern	Hemispherical
Polarisation	RHCP
Active Gain (dB)	28 @ 2.7 V
Voltage (V)	1.5 - 3.6
Current Consumption (mA)	9 Typ
Power Consumption (mW)	24.3 Typ
Saw Filter Type	Pre-Filter
ESD Protection (kV)	2



2J6047M

4GLTE/FirstNet/LPWA/NB-IoT/3G/2G & 2.4-5.0GHz/WiFi/LPWA/BT/ISM

- Key Features**
- ✔ Low Profile
 - ✔ Ground Plane Independent
 - ✔ Customizable Cable and Connector



White Black
Standard colors.
Other colors upon request.

General specification

Mounting type	Magnetic mount
Dimensions (mm)	80 × 76 × 13
Operating temperature	-40 °C to +85 °C

Antenna and electrical specifications

4GLTE/FirstNet/LPWA/NB-IoT/3G/2G (Connection 1)

Standards	4GLTE/FirstNet/LPWA/ CAT-X/CAT-Mx/CAT-NBx/NB-IoT/3G/2G
Frequency (MHz)	698-960, 1710-2170, 2500-2700
VSWR	~1.8:1, ~2.8:1, ~1.5:1
Efficiency (%)	~37.8, ~27.3, ~51.3
Peak Gain (dBi)	~1.5, ~3.2, ~6.0
Impedance (Ohm)	50
Polarisation	Linear
Radiation Pattern	Omni-Directional
Max. Input Power (W)	25

Antenna and electrical specifications

2.4-5.0GHz/WiFi/LPWA/BT/ISM (Connection 2)

Standards	WiFi/Sigfox/LoRa/LPWA/Bluetooth/ BLE/ZigBee/RFID/RFMA/ISM
Frequency (MHz)	2410-2490, 4920-5925
VSWR	~1.7:1, ~1.3:1
Efficiency (%)	~42.1, ~39.2
Peak Gain (dBi)	~3.0, ~4.8
Impedance (Ohm)	50
Polarisation	Linear
Radiation Pattern	Omni-Directional
Max. Input Power (W)	25

2J7747M

4GLTE/FirstNet/LPWA/NB-IoT/3G/2G & 2.4-5.0GHz/WiFi/LPWA/BT/ISM

- Key Features**
- ✔ High Performance
 - ✔ Ground Plane Dependent
 - ✔ Certificates: IP67 - Water Resistant, IP69 - Hot Water Pressure, IK09 - Impact Resistant
 - ✔ Customizable Cable and Connector



White Black
Standard colors.
Other colors upon request.

General specification

Mounting type	Magnetic mount
Dimensions (mm)	∅ 54 × 68.2
Operating temperature	-40 °C to +85 °C
Certificates	IP67, IP69, IK09

Antenna and electrical specifications

4GLTE/FirstNet/LPWA/NB-IoT/3G/2G (Connection 1)

Standards	4GLTE/FirstNet/LPWA/ CAT-X/CAT-Mx/CAT-NBx/NB-IoT/3G/2G
Frequency (MHz)	698-960, 1710-2170, 2500-2700
VSWR	~2.1:1, ~1.4:1, ~2.1:1
Efficiency (%)	~61.4, ~61.9, ~42.4
Peak Gain (dBi)	~2.2, ~3.7, ~3.2
Impedance (Ohm)	50
Polarisation	Linear
Radiation Pattern	Omni-Directional
Max. Input Power (W)	25

Antenna and electrical specifications

2.4-5.0GHz/WiFi/LPWA/BT/ISM (Connection 2)

Standards	WiFi/Sigfox/LoRa/LPWA/Bluetooth/ BLE/ZigBee/RFID/RFMA/ISM
Frequency (MHz)	2410-2490, 4920-5925
VSWR	~1.7:1, ~1.8:1
Efficiency (%)	~57.4, ~43.6
Peak Gain (dBi)	~4.5, ~4.8
Impedance (Ohm)	50
Polarisation	Linear
Radiation Pattern	Omni-Directional
Max. Input Power (W)	25



2J7807MG-433 Active GNSS

GPS/GLONASS/QZSS/Galileo/L1 & 433MHz/LPWA/RFID/ZigBee/ISM

- Key Features**
- ✔ Ground Plane Dependent
 - ✔ Customizable Cable and Connector
 - ✔ Certificates: IP67 - Water Resistant, IP69 - Hot Water Pressure



Standard colors.
Other colors upon request.

General specification

Mounting type	Magnetic mount
Dimensions (mm)	∅ 54 × 185
Operating temperature	-40 °C to +85 °C
Certificates	IP67, IP69

Antenna and electrical specifications

GPS/GLONASS/QZSS/Galileo/L1 (Connection 1)

Standards	GPS(L1)/GLONASS(L1OF)/QZSS(L1)/Galileo(E1)
Frequency (MHz)	1575.42, 1598-1606
VSWR	<1.2:1
Impedance (Ohm)	50
Radiation Pattern	Hemispherical
Polarisation	RHCP
Active Gain (dB)	26 @ 3V / 27dB @ 5V
Voltage (V)	2.7 - 5.5
Current Consumption (mA)	15 - 25
Power Consumption (mW)	40.5 - 137.5

Antenna and electrical specifications

433MHz/LPWA/RFID/ZigBee/ISM (Connection 2)

Standards	Sigfox/LoRa/RFID/LPWA/ISM/UHF
Frequency (MHz)	433-435
VSWR	~1.5:1
Efficiency (%)	~61
Peak Gain (dBi)	~0.3
Impedance (Ohm)	50
Polarisation	Linear
Radiation Pattern	Omni-Directional
Max. Input Power (W)	25

2J7239MG-915 Active GNSS

GPS/GLONASS/QZSS/Galileo/L1 & 915MHz/Sigfox/LoRa/LPWA/RFID/ZigBee/ISM

- Key Features**
- ✔ High Performance
 - ✔ Ground Plane Dependent
 - ✔ Certificates: IP67 - Water Resistant, IP69 - Hot Water Pressure
 - ✔ Customizable Cable and Connector



Standard colors.
Other colors upon request.

General specification

Mounting type	Magnetic mount
Dimensions (mm)	∅ 54 × 95.4
Operating temperature	-40 °C to +85 °C
Certificates	IP67, IP69

Antenna and electrical specifications

GPS/GLONASS/QZSS/Galileo/L1 (Connection 1)

Standards	GPS(L1)/GLONASS(L1OF)/QZSS(L1)/Galileo(E1)
Frequency (MHz)	1575.42, 1598-1606
VSWR	<1.2:1
Impedance (Ohm)	50
Radiation Pattern	Hemispherical
Polarisation	RHCP
Active Gain (dB)	26 @ 3V / 27dB @ 5V
Voltage (V)	2.7 - 5.5
Current Consumption (mA)	15 - 25
Power Consumption (mW)	40.5 - 137.5

Antenna and electrical specifications

915MHz/Sigfox/LoRa/LPWA/RFID/ZigBee/ISM (Connection 2)

Standards	Sigfox/LoRa/ZigBee/RFID/LPWA/ISM/UHF
Frequency (MHz)	902-928
VSWR	~1.2:1
Efficiency (%)	~46
Peak Gain (dBi)	~2.0
Impedance (Ohm)	50
Polarisation	Linear
Radiation Pattern	Omni-Directional
Max. Input Power (W)	25



2J7225MG Active GNSS GPS/GLONASS/QZSS/Galileo/L1 & 169MHz/ERMES/VHF

- Key Features**
- ✔ Ground Plane Dependent
 - ✔ Customizable Cable and Connector
 - ✔ Certificates: IP67 - Water Resistant, IP69 - Hot Water Pressure



White Black
Standard colors.
Other colors upon request.

General specification

Mounting type	Magnetic mount
Dimensions (mm)	Ø 54 × 95.4
Operating temperature	-40 °C to +85 °C
Certificates	IP67, IP69

Antenna and electrical specifications

GPS/GLONASS/QZSS/Galileo/L1 (Connection 1)

Standards	GPS(L1)/GLONASS(L10F)/QZSS(L1)/Galileo(E1)
Frequency (MHz)	1575.42, 1598-1606
VSWR	<1.2:1
Impedance (Ohm)	50
Radiation Pattern	Hemispherical
Polarisation	RHCP
Active Gain (dB)	26 @ 3V / 27dB @ 5V
Voltage (V)	2.7 - 5.5
Current Consumption (mA)	15 - 25
Power Consumption (mW)	40.5 - 137.5
ESD Protection (kV)	2

Antenna and electrical specifications

169MHz/ERMES/VHF (Connection 2)

Standards	169MHz/ERMES/VHF
Frequency (MHz)	169
VSWR	~1.7:1
Impedance (Ohm)	50
Polarisation	Linear
Radiation Pattern	Omni-Directional
Max. Input Power (W)	25

2J6533MGF Active GNSS GPS/GLONASS/QZSS/Galileo/L1 & IRIDIUM

- Key Features**
- ✔ Ground Plane Independent
 - ✔ Customizable Cable and Connector
 - ✔ Certificates: IP67 - Water Resistant, IP69 - Hot Water Pressure, IK09 - Impact Resistant
 - ✔ Pre-Filter GNSS



White Black
Standard colors.
Other colors upon request.

General specification

Mounting type	Magnetic mount
Dimensions (mm)	Ø 135.5 × 30.0
Operating temperature	-40 °C to +85 °C
Certificates	IP67, IP69, IK09

Antenna and electrical specifications

GPS/GLONASS/QZSS/Galileo/L1 (Connection 1)

Standards	GPS(L1)/GLONASS(L10F)/QZSS(L1)/Galileo(E1)
Frequency (MHz)	1575.42, 1598-1606
VSWR	<1.4:1
Impedance (Ohm)	50
Radiation Pattern	Hemispherical
Polarisation	RHCP
Active Gain (dB)	28 @ 2.7 V
Voltage (V)	1.5 - 3.6
Current Consumption (mA)	9 Typ
Power Consumption (mW)	24.3 Typ
Saw Filter Type	Pre-Filter
ESD Protection (kV)	6

Antenna and electrical specifications

IRIDIUM (Connection 2)

Standards	IRIDIUM
Frequency (MHz)	1616-1627
VSWR	~1.2:1
Efficiency (%)	~76
Peak Gain (dBi)	~4.5
Impedance (Ohm)	50
Polarisation	RHCP
Radiation Pattern	Hemispherical
Axial Ratio (dB)	3 max.



2J7929MGF Active GNSS GPS/GLONASS/QZSS/Galileo/L1 & ORBCOMM

- Key Features**
- ✔ High Performance
 - ✔ Ground Plane Dependent
 - ✔ Certificates: IP67 - Water Resistant, IP69 - Hot Water Pressure
 - ✔ Customizable Cable and Connector
 - ✔ Pre-Filter GNSS



General specification

Mounting type	Magnetic mount
Dimensions (mm)	∅ 54 × 406
Operating temperature	-40 °C to +85 °C
Certificates	IP67, IP69

Antenna and electrical specifications

GPS/GLONASS/QZSS/Galileo/L1 (Connection 1)

Standards	GPS(L1)/GLONASS(L1OF)/QZSS(L1)/Galileo(E1)
Frequency (MHz)	1575.42, 1598-1606
VSWR	<1.2:1
Impedance (Ohm)	50
Radiation Pattern	Hemispherical
Polarisation	RHCP
Active Gain (dB)	26 @ 3V / 27dB @ 5V
Voltage (V)	2.7 - 5.5
Current Consumption (mA)	15 - 25
Power Consumption (mW)	40.5 - 137.5
Saw Filter Type	Pre-Filter
ESD Protection (kV)	2

Antenna and electrical specifications

ORBCOMM (Connection 2)

Standards	ORBCOMM
Frequency (MHz)	137-150
VSWR	~2.1:1
Impedance (Ohm)	50
Polarisation	Linear
Radiation Pattern	Omni-Directional
Max. Input Power (W)	25



2J7741MGFa Active GNSS 2x 4G LTE/FirstNet/LPWA/NB-IoT/3G/2G & GPS/GLONASS/QZSS/Galileo/L1

- Key Features**
- High Performance
 - Ground Plane Dependent
 - Certificates: IP67 - Water Resistant, IP69 - Hot Water Pressure, IK09 - Impact Resistant
 - Customizable Cable and Connector
 - Pre-Filter GNSS



Standard colors.
Other colors upon request.

General specification

Mounting type	Magnetic mount
Dimensions (mm)	∅ 54 × 68.2
Operating temperature	-40 °C to +85 °C
Certificates	IP67, IP69, IK09

Antenna and electrical specifications

4G LTE/FirstNet/LPWA/NB-IoT/3G/2G (Connection 1)

Standards	4G LTE/FirstNet/LPWA/ CAT-X/CAT-Mx/CAT-NBx/NB-IoT/3G/2G
Frequency (MHz)	698-960, 1710-2170, 2500-2700
VSWR	~2.7:1, ~1.5:1, ~1.4:1
Efficiency (%)	~39, ~52, ~50
Peak Gain (dBi)	~-0.1, ~2.9, ~3.5
Impedance (Ohm)	50
Polarisation	Linear
Radiation Pattern	Omni-Directional
Max. Input Power (W)	25

Antenna and electrical specifications

4G LTE/FirstNet/LPWA/NB-IoT/3G/2G (Connection 2)

Standards	4G LTE/FirstNet/LPWA/ CAT-X/CAT-Mx/CAT-NBx/NB-IoT/3G/2G
Frequency (MHz)	698-960, 1710-2170, 2500-2700
VSWR	~2.7:1, ~1.5:1, ~1.5:1
Efficiency (%)	~38, ~52, ~53
Peak Gain (dBi)	~-0.1, ~3.1, ~2.7
Impedance (Ohm)	50
Polarisation	Linear
Radiation Pattern	Omni-Directional
Max. Input Power (W)	25

Antenna and electrical specifications

GPS/GLONASS/QZSS/Galileo/L1 (Connection 3)

Standards	GPS(L1)/GLONASS(L10F)/QZSS(L1)/Galileo(E1)
Frequency (MHz)	1575.42, 1598-1606
VSWR	<1.4:1
Impedance (Ohm)	50
Radiation Pattern	Hemispherical
Polarisation	RHCP
Active Gain (dB)	28 @ 2.7 V
Voltage (V)	1.5 - 3.6
Current Consumption (mA)	9 Typ
Power Consumption (mW)	24.3 Typ
Saw Filter Type	Pre-Filter
ESD Protection (kV)	2

2J6041MGFa Active GNSS 2x 4G LTE/FirstNet/LPWA/NB-IoT/3G/2G & GPS/GLONASS/QZSS/Galileo/L1

- Key Features**
- Low Profile
 - Ground Plane Independent
 - Customizable Cable and Connector
 - Pre-Filter GNSS

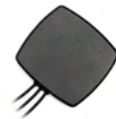

Standard colors.
Other colors upon request.

General specification

Mounting type	Magnetic mount
Dimensions (mm)	80 × 76 × 13
Operating temperature	-40 °C to +85 °C

Antenna and electrical specifications

4G LTE/FirstNet/LPWA/NB-IoT/3G/2G (Connection 1)

Standards	4G LTE/FirstNet/LPWA/ CAT-X/CAT-Mx/CAT-NBx/NB-IoT/3G/2G
Frequency (MHz)	698-960, 1710-2170, 2500-2700
VSWR	~1.5:1, ~2.0:1, ~1.7:1
Efficiency (%)	~34.1, ~31.3, ~37.0
Peak Gain (dBi)	~-1.9, ~2.9, ~3.9
Impedance (Ohm)	50
Polarisation	Linear
Radiation Pattern	Omni-Directional
Max. Input Power (W)	25

Antenna and electrical specifications

4G LTE/FirstNet/LPWA/NB-IoT/3G/2G (Connection 2)

Standards	4G LTE/FirstNet/LPWA/ CAT-X/CAT-Mx/CAT-NBx/NB-IoT/3G/2G
Frequency (MHz)	698-960, 1710-2170, 2500-2700
VSWR	~2.2:1, ~2.4:1, ~1.5:1
Efficiency (%)	~27, ~23.1, ~40.6
Peak Gain (dBi)	~-0.3, ~1.9, ~3.5
Impedance (Ohm)	50
Polarisation	Linear
Radiation Pattern	Omni-Directional
Max. Input Power (W)	25

Antenna and electrical specifications

GPS/GLONASS/QZSS/Galileo/L1 (Connection 3)

Standards	GPS(L1)/GLONASS(L10F)/QZSS(L1)/Galileo(E1)
Frequency (MHz)	1575.42, 1598-1606
VSWR	<1.4:1
Impedance (Ohm)	50
Radiation Pattern	Hemispherical
Polarisation	RHCP
Active Gain (dB)	28 @ 2.7 V
Voltage (V)	1.5 - 3.6
Current Consumption (mA)	9 Typ
Power Consumption (mW)	24.3 Typ
Saw Filter Type	Pre-Filter
ESD Protection (kV)	2



2J6541MGFa

Active GNSS, for EU LTE only

2x 4GLTE/FirstNet/LPWA/NB-IoT/3G/2G & GPS/GLONASS/QZSS/Galileo/L1

- Key Features**
- ✔ Ground Plane Dependent
 - ✔ Customizable Cable and Connector
 - ✔ Certificates: IP67 - Water Resistant, IP69 - Hot Water Pressure, IK09 - Impact Resistant
 - ✔ Pre-Filter GNSS



Standard colors. Other colors upon request.

General specification

Mounting type	Magnetic mount
Dimensions (mm)	∅ 135.5 × 30.0
Operating temperature	-40 °C to +85 °C
Certificates	IP67, IP69, IK09

Antenna and electrical specifications

4GLTE/FirstNet/LPWA/NB-IoT/3G/2G (Connection 1)

Standards	4GLTE/FirstNet/LPWA/ CAT-X/CAT-Mx/CAT-NBx/NB-IoT/3G/2G
Frequency (MHz)	791-960, 1710-2170, 2500-2700
VSWR	~2.7:1, ~1.6:1, ~2.1:1
Efficiency (%)	~35.7, ~39.8, ~21.1
Peak Gain (dBi)	~-0.3, ~2.6, ~-0.4
Impedance (Ohm)	50
Polarisation	Linear
Radiation Pattern	Omni-Directional
Max. Input Power (W)	25

Antenna and electrical specifications

4GLTE/FirstNet/LPWA/NB-IoT/3G/2G (Connection 2)

Standards	4GLTE/FirstNet/LPWA/ CAT-X/CAT-Mx/CAT-NBx/NB-IoT/3G/2G
Frequency (MHz)	791-960, 1710-2170, 2500-2700
VSWR	~2.1:1, ~1.4:1, ~1.5:1
Efficiency (%)	~23.9, ~25.7, ~14.1
Peak Gain (dBi)	~-1.2, ~0.9, ~-1.5
Impedance (Ohm)	50
Polarisation	Linear
Radiation Pattern	Omni-Directional
Max. Input Power (W)	25

Antenna and electrical specifications

GPS/GLONASS/QZSS/Galileo/L1 (Connection 3)

Standards	GPS(L1)/GLONASS(L10F)/QZSS(L1)/Galileo(E1)
Frequency (MHz)	1575.42, 1598-1606
VSWR	<1.4:1
Impedance (Ohm)	50
Radiation Pattern	Hemispherical
Polarisation	RHCP
Active Gain (dB)	28 @ 2.7 V
Voltage (V)	1.5 - 3.6
Current Consumption (mA)	9 Typ
Power Consumption (mW)	24.3 Typ
Saw Filter Type	Pre-Filter
ESD Protection (kV)	6

2J7750MGF Active GNSS

4GLTE/FirstNet/LPWA/NB-IoT/3G/2G & GPS/GLONASS/QZSS/Galileo/L1 & 2.4-5.0GHz/WiFi/LPWA/BT/ISM

- Key Features**
- ✔ High Performance
 - ✔ Ground Plane Dependent
 - ✔ Certificates: IP67 - Water Resistant, IP69 - Hot Water Pressure, IK09 - Impact Resistant
 - ✔ Customizable Cable and Connector
 - ✔ Pre-Filter GNSS

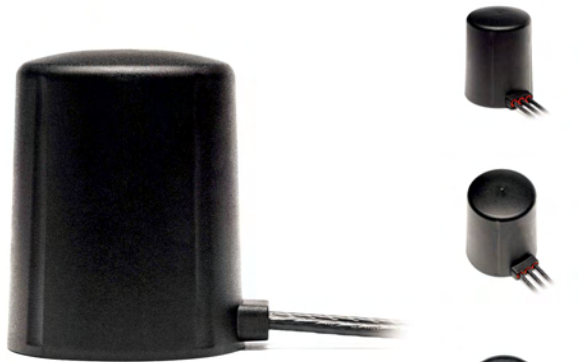

Standard colors. Other colors upon request.

General specification

Mounting type	Magnetic mount
Dimensions (mm)	∅ 54 × 68.2
Operating temperature	-40 °C to +85 °C
Certificates	IP67, IP69, IK09

Antenna and electrical specifications

4GLTE/FirstNet/LPWA/NB-IoT/3G/2G (Connection 1)

Standards	4GLTE/FirstNet/LPWA/ CAT-X/CAT-Mx/CAT-NBx/NB-IoT/3G/2G
Frequency (MHz)	698-960, 1710-2170, 2500-2700
VSWR	~2.1:1, ~1.4:1, ~2.1:1
Efficiency (%)	~61.4, ~61.9, ~42.4
Peak Gain (dBi)	~-2.2, ~-3.7, ~-3.2
Impedance (Ohm)	50
Polarisation	Linear
Radiation Pattern	Omni-Directional
Max. Input Power (W)	25

Antenna and electrical specifications

GPS/GLONASS/QZSS/Galileo/L1 (Connection 2)

Standards	GPS(L1)/GLONASS(L10F)/QZSS(L1)/Galileo(E1)
Frequency (MHz)	1575.42, 1598-1606
VSWR	<1.4:1
Impedance (Ohm)	50
Radiation Pattern	Hemispherical
Polarisation	RHCP
Active Gain (dB)	28 @ 2.7 V
Voltage (V)	1.5 - 3.6
Current Consumption (mA)	9 Typ
Power Consumption (mW)	24.3 Typ
Saw Filter Type	Pre-Filter
ESD Protection (kV)	2

Antenna and electrical specifications

2.4-5.0GHz/WiFi/LPWA/BT/ISM (Connection 3)

Standards	WiFi/Sigfox/LoRa/LPWA/Bluetooth/ BLE/ZigBee/RFID/RFMA/ISM
Frequency (MHz)	2410-2490, 4920-5925
VSWR	~1.7:1, ~1.8:1
Efficiency (%)	~57.4, ~43.6
Peak Gain (dBi)	~-4.5, ~-4.8
Impedance (Ohm)	50
Polarisation	Linear
Radiation Pattern	Omni-Directional
Max. Input Power (W)	25



2J6050MGF Active GNSS 4G LTE/FirstNet/LPWA/NB-IoT/3G/2G & GPS/GLONASS/QZSS/Galileo/L1 & 2.4-5.0GHz/WiFi/LPWA/BT/ISM

- Key Features**
- ✔ Low Profile
 - ✔ Ground Plane Independent
 - ✔ Customizable Cable and Connector
 - ✔ Pre-Filter GNSS



White Black
Standard colors.
Other colors upon request.

General specification

Mounting type	Magnetic mount
Dimensions (mm)	80 × 76 × 13
Operating temperature	-40 °C to +85 °C

Antenna and electrical specifications

4G LTE/FirstNet/LPWA/NB-IoT/3G/2G (Connection 1)

Standards	4G LTE/FirstNet/LPWA/ CAT-X/CAT-Mx/CAT-NBx/NB-IoT/3G/2G
Frequency (MHz)	698-960, 1710-2170, 2500-2700
VSWR	~2.6:1, ~2.5:1, ~1.6:1
Efficiency (%)	~40.1, ~46.3, ~49.2
Peak Gain (dBi)	~1.9, ~4.2, ~5.7
Impedance (Ohm)	50
Polarisation	Linear
Radiation Pattern	Omni-Directional
Max. Input Power (W)	25

Antenna and electrical specifications

GPS/GLONASS/QZSS/Galileo/L1 (Connection 2)

Standards	GPS(L1)/GLONASS(L10F)/QZSS(L1)/Galileo(E1)
Frequency (MHz)	1575.42, 1598-1606
VSWR	<1.4:1
Impedance (Ohm)	50
Radiation Pattern	Hemispherical
Polarisation	RHCP
Active Gain (dB)	28 @ 2.7 V
Voltage (V)	1.5 - 3.6
Current Consumption (mA)	9 Typ
Power Consumption (mW)	24.3 Typ
Saw Filter Type	Pre-Filter
ESD Protection (kV)	2

Antenna and electrical specifications

2.4-5.0GHz/WiFi/LPWA/BT/ISM (Connection 3)

Standards	WiFi/Sigfox/LoRa/LPWA/Bluetooth/ BLE/ZigBee/RFID/RFMA/ISM
Frequency (MHz)	2410-2490, 4920-5925
VSWR	~1.7:1, ~1.5:1
Efficiency (%)	~44.8, ~29.8
Peak Gain (dBi)	~2.8, ~3.6
Impedance (Ohm)	50
Polarisation	Linear
Radiation Pattern	Omni-Directional
Max. Input Power (W)	25

2J6552MGF Active GNSS 3G/2G/CELLULAR & GPS/GLONASS/QZSS/Galileo/L1 & IRIDIUM

- Key Features**
- ✔ Ground Plane Dependent
 - ✔ Customizable Cable and Connector
 - ✔ Certificates: IP67 - Water Resistant, IP69 - Hot Water Pressure, IK09 - Impact Resistant
 - ✔ Pre-Filter GNSS



White Black
Standard colors.
Other colors upon request.

General specification

Mounting type	Magnetic mount
Dimensions (mm)	Ø 135.5 × 30.0
Operating temperature	-40 °C to +85 °C
Certificates	IP67, IP69, IK09

Antenna and electrical specifications

3G/2G/CELLULAR (Connection 1)

Standards	3G/Cellular/HSPA/UMTS/WCDA/ EDGE/EGPRS/GRPS/GSM/CDMA/2G
Frequency (MHz)	824-960, 1710-2170
VSWR	~2.4:1, ~1.5:1
Efficiency (%)	~39.4, ~40.7
Peak Gain (dBi)	~1.6, ~2.7
Impedance (Ohm)	50
Polarisation	Linear
Radiation Pattern	Omni-Directional
Max. Input Power (W)	25

Antenna and electrical specifications

GPS/GLONASS/QZSS/Galileo/L1 (Connection 2)

Standards	GPS(L1)/GLONASS(L10F)/QZSS(L1)/Galileo(E1)
Frequency (MHz)	1575.42, 1598-1606
VSWR	<1.4:1
Impedance (Ohm)	50
Radiation Pattern	Hemispherical
Polarisation	RHCP
Active Gain (dB)	28 @ 2.7 V
Voltage (V)	1.5 - 3.6
Current Consumption (mA)	9 Typ
Power Consumption (mW)	24.3 Typ
Saw Filter Type	Pre-Filter
ESD Protection (kV)	6

Antenna and electrical specifications

IRIDIUM (Connection 3)

Standards	IRIDIUM
Frequency (MHz)	1616-1627
VSWR	~1.2:1
Efficiency (%)	~76
Peak Gain (dBi)	~4.5
Impedance (Ohm)	50
Polarisation	Linear
Radiation Pattern	Omni-Directional
Max. Input Power (W)	25



2J6581MGF-433 Active GNSS

GPS/GLONASS/QZSS/Galileo/L1 & 2.4GHz/WiFi/LPWA/BT/ISM & 433MHz/LPWA/RFID/ZigBee/ISM

- Key Features**
- ✓ Ground Plane Dependent
 - ✓ Customizable Cable and Connector
 - ✓ Certificates: IP67 - Water Resistant, IP69 - Hot Water Pressure, IK09 - Impact Resistant
 - ✓ Pre-Filter GNSS

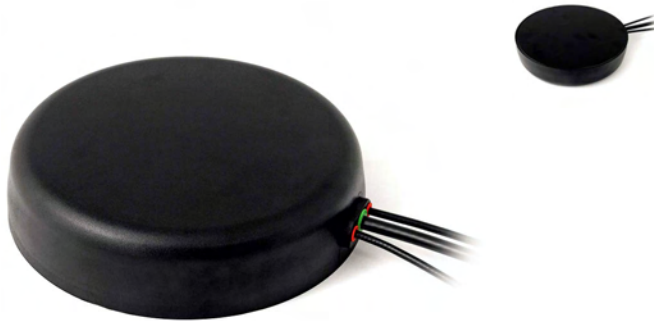

Standard colors. Other colors upon request.

General specification

Mounting type	Magnetic mount
Dimensions (mm)	Ø 135.5 × 30.0
Operating temperature	-40 °C to +85 °C
Certificates	IP67, IP69, IK09

Antenna and electrical specifications

GPS/GLONASS/QZSS/Galileo/L1 (Connection 1)

Standards	GPS(L1)/GLONASS(L1OF)/QZSS(L1)/Galileo(E1)
Frequency (MHz)	1575.42, 1598-1606
VSWR	<1.4:1
Impedance (Ohm)	50
Radiation Pattern	Hemispherical
Polarisation	RHCP
Active Gain (dB)	28 @ 2.7 V
Voltage (V)	1.5 - 3.6
Current Consumption (mA)	9 Typ
Power Consumption (mW)	24.3 Typ
Saw Filter Type	Pre-Filter
ESD Protection (kV)	6

Antenna and electrical specifications

2.4GHz/WiFi/LPWA/BT/ISM (Connection 3)

Standards	WiFi/Sigfox/LoRa/LPWA/Bluetooth/BLE/ZigBee/RFID/RFMA/ISM
Frequency (MHz)	2410-2490
VSWR	~1.5:1
Efficiency (%)	~29.2
Peak Gain (dBi)	~2.2
Impedance (Ohm)	50
Polarisation	Linear
Radiation Pattern	Omni-Directional
Max. Input Power (W)	25

Antenna and electrical specifications

433MHz/LPWA/RFID/ZigBee/ISM (Connection 3)

Standards	Sigfox/LoRa/RFID/LPWA/ISM/UHF
Frequency (MHz)	433-435
VSWR	~1.7:1
Efficiency (%)	~61.6
Peak Gain (dBi)	~2.6
Impedance (Ohm)	50
Polarisation	Linear
Radiation Pattern	Omni-Directional
Max. Input Power (W)	50



2J6024MPa

2x 4GLTE/FirstNet/LPWA/NB-IoT/3G/2G

- Key Features**
- ✔ Low Profile
 - ✔ Ground Plane Independent
 - ✔ Customizable Cable and Connector

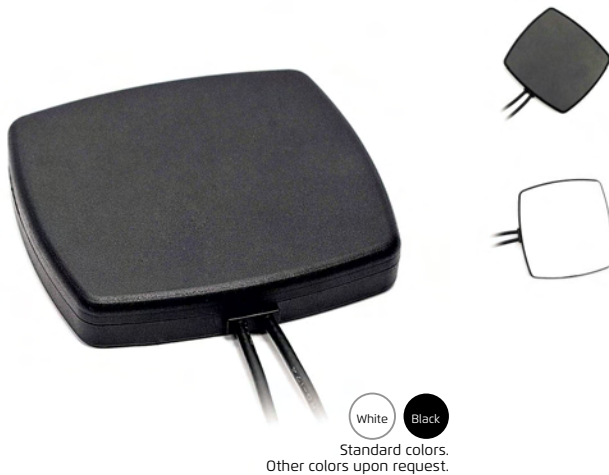

White Black
Standard colors.
Other colors upon request.

General specification

Mounting type	Magnetic/Adhesive mount
Dimensions (mm)	80 × 76 × 13
Operating temperature	-40 °C to +85 °C

Antenna and electrical specifications

4GLTE/FirstNet/LPWA/NB-IoT/3G/2G (Connection 1)

Standards	4GLTE/FirstNet/LPWA/ CAT-X/CAT-Mx/CAT-NBx/NB-IoT/3G/2G
Frequency (MHz)	698-960, 1710-2170, 2500-2700
VSWR	~2.2:1, ~2.6:1, ~2.1:1
Efficiency (%)	~25.3, ~20.2, ~36.1
Peak Gain (dBi)	~-0.7, ~-1.7, ~-4.4
Impedance (Ohm)	50
Polarisation	Linear
Radiation Pattern	Omni-Directional
Max. Input Power (W)	25

Antenna and electrical specifications

4GLTE/FirstNet/LPWA/NB-IoT/3G/2G (Connection 2)

Standards	4GLTE/FirstNet/LPWA/ CAT-X/CAT-Mx/CAT-NBx/NB-IoT/3G/2G
Frequency (MHz)	698-960, 1710-2170, 2500-2700
VSWR	~2.5:1, ~2.5:1, ~2.2:1
Efficiency (%)	~25.7, ~22.5, ~35.2
Peak Gain (dBi)	~-0.8, ~-1.8, ~-4.5
Impedance (Ohm)	50
Polarisation	Linear
Radiation Pattern	Omni-Directional
Max. Input Power (W)	25

2J4600MPGF Active GNSS

3G/2G/CELLULAR & GPS/GLONASS/QZSS/Galileo/L1

- Key Features**
- ✔ Low Profile
 - ✔ Ground Plane Independent
 - ✔ For Metal and Non-Metal Surface
 - ✔ Customizable Cable and Connector
 - ✔ Pre-Filter GNSS



White Black
Standard colors.
Other colors upon request.

General specification

Mounting type	Magnetic/Adhesive mount
Dimensions (mm)	50 × 40 × 12.5 (13.5)
Operating temperature	-40 °C to +85 °C

Antenna and electrical specifications

3G/2G/CELLULAR (Connection 1)

Standards	3G/Cellular/HSPA/UMTS/WCDA/ EDGE/EGPRS/GRPS/GSM/CDMA/2G
Frequency (MHz)	824-960, 1710-2170
VSWR	~1.8:1, ~1.5:1
Efficiency (%)	~28.2, ~20.7
Peak Gain (dBi)	~-0.4, ~-2.6
Impedance (Ohm)	50
Polarisation	Linear
Radiation Pattern	Omni-Directional
Max. Input Power (W)	25

Antenna and electrical specifications

GPS/GLONASS/QZSS/Galileo/L1 (Connection 2)

Standards	GPS(L1)/GLONASS(L1OF)/QZSS(L1)/Galileo(E1)
Frequency (MHz)	1575.42, 1598-1606
VSWR	<1.5:1
Impedance (Ohm)	50
Radiation Pattern	Hemispherical
Polarisation	RHCP
Active Gain (dB)	26 @ 3V
Voltage (V)	2.7 - 5.5
Current Consumption (mA)	15 - 25
Power Consumption (mW)	40.5 - 137.5
Saw Filter Type	Pre-Filter



2J6300MPGF Active GNSS

3G/2G/CELLULAR & GPS/GLONASS/QZSS/Galileo/L1

- Key Features**
- ✔ Low Profile
 - ✔ Ground Plane Independent
 - ✔ For Metal and Non-Metal Surface
 - ✔ Customizable Cable and Connector
 - ✔ Certificates: IP67 - Water Resistant
 - ✔ Pre-Filter GNSS



Standard colors.
Other colors upon request.

General specification

Mounting type	Magnetic/Adhesive mount
Dimensions (mm)	Ø 52.5 × 14.3
Operating temperature	-40 °C to +85 °C
Certificates	IP67

Antenna and electrical specifications

3G/2G/CELLULAR (Connection 1)

Standards	3G/Cellular/HSPA/UMTS/WCDA/ EDGE/EGPRS/GRPS/GSM/CDMA/2G
Frequency (MHz)	824-960, 1710-2170
VSWR	~1.9:1, ~2.1:1
Efficiency (%)	~33.4, ~9.8
Peak Gain (dBi)	~1.2, ~-3.1
Impedance (Ohm)	50
Polarisation	Linear
Radiation Pattern	Omni-Directional
Max. Input Power (W)	25

Antenna and electrical specifications

GPS/GLONASS/QZSS/Galileo/L1 (Connection 2)

Standards	GPS(L1)/GLONASS(L1OF)/QZSS(L1)/Galileo(E1)
Frequency (MHz)	1575.42, 1598-1606
VSWR	<1.5:1
Impedance (Ohm)	50
Radiation Pattern	Hemispherical
Polarisation	RHCP
Active Gain (dB)	26 @ 3V
Voltage (V)	2.7 - 5.5
Current Consumption (mA)	15 - 25
Power Consumption (mW)	40.5 - 137.5
Saw Filter Type	Pre-Filter



2J9524a

2x 4GLTE/FirstNet/LPWA/NB-IoT/3G/2G

- Key Features**
- ✔ High Performance
 - ✔ Ground Plane Independent
 - ✔ Customizable Cable and Connector
 - ✔ Certificates: IP69 - Hot Water Pressure



Standard colors.
Other colors upon request.

General specification

Mounting type	Pole mount
Dimensions (mm)	280 × 280 × 118
Operating temperature	-40 °C to +85 °C
Certificates	IP69

Antenna and electrical specifications

4GLTE/FirstNet/LPWA/NB-IoT/3G/2G (Connection 1)

Standards	4GLTE/FirstNet/LPWA/ CAT-X/CAT-Mx/CAT-NBx/NB-IoT/3G/2G
Frequency (MHz)	698-960, 1710-2170, 2500-2700
VSWR	~1.7:1, ~1.3:1, ~1.3:1
Efficiency (%)	~72, ~71, ~72
Peak Gain (dBi)	~3.5, ~4.6, ~3.9
Impedance (Ohm)	50
Polarisation	Linear
Radiation Pattern	Omni-Directional
Max. Input Power (W)	25

Antenna and electrical specifications

4GLTE/FirstNet/LPWA/NB-IoT/3G/2G (Connection 2)

Standards	4GLTE/FirstNet/LPWA/ CAT-X/CAT-Mx/CAT-NBx/NB-IoT/3G/2G
Frequency (MHz)	698-960, 1710-2170, 2500-2700
VSWR	~1.7:1, ~1.3:1, ~1.2:1
Efficiency (%)	~74, ~72, ~70
Peak Gain (dBi)	~3.8, ~5.8, ~4.0
Impedance (Ohm)	50
Polarisation	Linear
Radiation Pattern	Omni-Directional
Max. Input Power (W)	25



2J9547a

**2x 4GLTE/FirstNet/LPWA/NB-IoT/3G/2G &
2x 2.4-5.0GHz/WiFi/LPWA/BT/ISM**

- Key Features**
- ✔ High Performance
 - ✔ Ground Plane Independent
 - ✔ Customizable Cable and Connector
 - ✔ Certificates: IP69 - Hot Water Pressure



Standard colors.
Other colors upon request.



Antenna and electrical specifications

2.4-5.0GHz/WiFi/LPWA/BT/ISM (Connection 3)

Standards	WiFi/Sigfox/LoRa/LPWA/Bluetooth/ BLE/ZigBee/RFID/RPMA/ISM
Frequency (MHz)	2410-2490, 4920-5925
VSWR	~1.8:1, ~2.2:1
Efficiency (%)	~48, ~44
Peak Gain (dBi)	~2.9, ~2.7
Impedance (Ohm)	50
Polarisation	Linear
Radiation Pattern	Omni-Directional
Max. Input Power (W)	25

General specification

Mounting type	Pole mount
Dimensions (mm)	280 x 280 x 118
Operating temperature	-40 °C to +85 °C
Certificates	IP69

Antenna and electrical specifications

4GLTE/FirstNet/LPWA/NB-IoT/3G/2G (Connection 1)

Standards	4GLTE/FirstNet/LPWA/ CAT-X/CAT-Mx/CAT-NBx/NB-IoT/3G/2G
Frequency (MHz)	698-960, 1710-2170, 2500-2700
VSWR	~1.7:1, ~1.3:1, ~1.3:1
Efficiency (%)	~72, ~71, ~72
Peak Gain (dBi)	~3.5, ~4.6, ~3.9
Impedance (Ohm)	50
Polarisation	Linear
Radiation Pattern	Omni-Directional
Max. Input Power (W)	25

Antenna and electrical specifications

4GLTE/FirstNet/LPWA/NB-IoT/3G/2G (Connection 2)

Standards	4GLTE/FirstNet/LPWA/ CAT-X/CAT-Mx/CAT-NBx/NB-IoT/3G/2G
Frequency (MHz)	698-960, 1710-2170, 2500-2700
VSWR	~1.7:1, ~1.3:1, ~1.2:1
Efficiency (%)	~74, ~72, ~70
Peak Gain (dBi)	~3.8, ~5.8, ~4.0
Impedance (Ohm)	50
Polarisation	Linear
Radiation Pattern	Omni-Directional
Max. Input Power (W)	25

Antenna and electrical specifications

2.4-5.0GHz/WiFi/LPWA/BT/ISM (Connection 4)

Standards	WiFi/Sigfox/LoRa/LPWA/Bluetooth/ BLE/ZigBee/RFID/RPMA/ISM
Frequency (MHz)	2410-2490, 4920-5925
VSWR	~2.0:1, ~2.2:1
Efficiency (%)	~75, ~50
Peak Gain (dBi)	~5.2, ~3.3
Impedance (Ohm)	50
Polarisation	Linear
Radiation Pattern	Omni-Directional
Max. Input Power (W)	25



2J7050JGFa Active GNSS 2x 4G LTE/FirstNet/LPWA/NB-IoT/3G/2G & 2x 2.4-5.0GHz/WiFi/LPWA/BT/ISM & GPS/GLONASS/QZSS/Galileo/L1

- Key Features**
- High Performance
 - Customizable Cable and Connector
 - Ground Plane Independent
 - Heavy Duty antenna
 - For Ø 43,2mm Pole Mount
 - Certificates: IP67 - Water Resistant, IP69 - Hot Water Pressure, IK09 - Impact Resistant
 - Certified for Railway industry
 - Pre-Filter GNSS

General specification

Mounting type	Pole mount
Dimensions (mm)	Ø 96 x 90
Operating temperature	-40 °C to +85 °C
Certificates	IP67, IP69, IK09, Certified for Railway industry



White Black
Standard colors.
Other colors upon request.



Antenna and electrical specifications

4G LTE/FirstNet/LPWA/NB-IoT/3G/2G (Connection 1)

Standards	4G LTE/FirstNet/LPWA/ CAT-X/CAT-Mx/CAT-NBx/NB-IoT/3G/2G
Frequency (MHz)	698-960, 1710-2170, 2500-2700
VSWR	~1.9:1, ~1.6:1, ~1.7:1
Efficiency (%)	~57, ~57, ~47
Peak Gain (dBi)	~2.1, ~4.2, ~3.1
Impedance (Ohm)	50
Polarisation	Linear
Radiation Pattern	Omni-Directional
Max. Input Power (W)	25

Antenna and electrical specifications

4G LTE/FirstNet/LPWA/NB-IoT/3G/2G (Connection 2)

Standards	4G LTE/FirstNet/LPWA/ CAT-X/CAT-Mx/CAT-NBx/NB-IoT/3G/2G
Frequency (MHz)	698-960, 1710-2170, 2500-2700
VSWR	~1.9:1, ~1.6:1, ~1.4:1
Efficiency (%)	~63, ~54, ~57
Peak Gain (dBi)	~3.0, ~3.2, ~4.0
Impedance (Ohm)	50
Polarisation	Linear
Radiation Pattern	Omni-Directional
Max. Input Power (W)	25

Antenna and electrical specifications

2.4-5.0GHz/WiFi/LPWA/BT/ISM (Connection 3)

Standards	WiFi/Sigfox/LoRa/LPWA/Bluetooth/ BLE/ZigBee/RFID/RFMA/ISM
Frequency (MHz)	2410-2490, 4920-5925
VSWR	~1.9:1, ~1.6:1
Efficiency (%)	~58, ~64
Peak Gain (dBi)	~5.6, ~5.5
Impedance (Ohm)	50
Polarisation	Linear
Radiation Pattern	Omni-Directional
Max. Input Power (W)	25

Antenna and electrical specifications

GPS/GLONASS/QZSS/Galileo/L1 (Connection 5)

Standards	GPS(L1)/GLONASS(L10F)/QZSS(L1)/Galileo(E1)
Frequency (MHz)	1575.42, 1598-1606
VSWR	<1.5:1
Impedance (Ohm)	50
Radiation Pattern	Hemispherical
Polarisation	RHCP
Active Gain (dB)	28 @ 2.7 V
Voltage (V)	1.5 - 3.6
Current Consumption (mA)	9 Typ
Power Consumption (mW)	24.3 Typ
Saw Filter Type	Pre-Filter
ESD Protection (kV)	6

Antenna and electrical specifications

2.4-5.0GHz/WiFi/LPWA/BT/ISM (Connection 4)

Standards	WiFi/Sigfox/LoRa/LPWA/Bluetooth/ BLE/ZigBee/RFID/RFMA/ISM
Frequency (MHz)	2410-2490, 4920-5925
VSWR	~2.1:1, ~1.6:1
Efficiency (%)	~57, ~59
Peak Gain (dBi)	~5.5, ~4.4
Impedance (Ohm)	50
Polarisation	Linear
Radiation Pattern	Omni-Directional
Max. Input Power (W)	25



2J9637JBWGF-B12JWa-B10BW Active GNSS GPS/GLONASS/QZSS/Galileo/L1 & AIS

- Key Features** ✓ Ground Plane Independent ✓ Customizable Cable and Connector
 ✓ Certificates: IP67 - Water Resistant ✓ Pre-Filter GNSS



White Black
 Standard colors.
 Other colors upon request.

General specification

Mounting type	Pole/Screw mount
Dimensions (mm)	248 × 74 × 110
Operating temperature	-40 °C to +85 °C
Certificates	IP67

Antenna and electrical specifications

GPS/GLONASS/QZSS/Galileo/L1 (Connection 1)

Standards	GPS(L1)/GLONASS(L1OF)/QZSS(L1)/Galileo(E1)
Frequency (MHz)	1575.42, 1598-1606
VSWR	<1.4:1
Impedance (Ohm)	50
Radiation Pattern	Hemispherical
Polarisation	RHCP
Active Gain (dB)	23 @ 3V, 24 @ 5V
Voltage (V)	2.7 - 5.5
Current Consumption (mA)	15 - 25
Power Consumption (mW)	138 Max
Saw Filter Type	Pre-Filter

Antenna and electrical specifications

AIS (Connection 2)

Standards	AIS
Frequency (MHz)	162
Return Loss (dB)	~12
VSWR	~1.6:1
Impedance (Ohm)	50
Polarisation	Linear
Radiation Pattern	Omni-Directional
Max. Input Power (W)	25

2J9607JBWGF-B12JWa-B10BW Active GNSS GPS/GLONASS/QZSS/Galileo/L1 & 380-470MHz/LPWA/TETRA/UHF

- Key Features** ✓ Ground Plane Independent ✓ Customizable Cable and Connector
 ✓ Certificates: IP67 - Water Resistant ✓ Pre-Filter GNSS



White Black
 Standard colors.
 Other colors upon request.

General specification

Mounting type	Pole/Screw mount
Dimensions (mm)	252 × 74 × 110
Operating temperature	-40 °C to +85 °C
Certificates	IP67

Antenna and electrical specifications

GPS/GLONASS/QZSS/Galileo/L1 (Connection 1)

Standards	GPS(L1)/GLONASS(L1OF)/QZSS(L1)/Galileo(E1)
Frequency (MHz)	1575.42, 1598-1606
VSWR	<1.4:1
Impedance (Ohm)	50
Radiation Pattern	Hemispherical
Polarisation	RHCP
Active Gain (dB)	23 @ 3V, 24 @ 5V
Voltage (V)	2.7 - 5.5
Current Consumption (mA)	15 - 25
Power Consumption (mW)	138 Max
Saw Filter Type	Pre-Filter
ESD Protection (kV)	

Antenna and electrical specifications

380-470MHz/LPWA/TETRA/UHF (Connection 2)

Standards	TETRA/UHF/PMR/LMR
Frequency (MHz)	350-470
VSWR	~2.2:1
Efficiency (%)	~25
Peak Gain (dBi)	~-2.0
Impedance (Ohm)	50
Polarisation	Linear
Radiation Pattern	Omni-Directional
Max. Input Power (W)	100

Single & Combination Internal Antennas

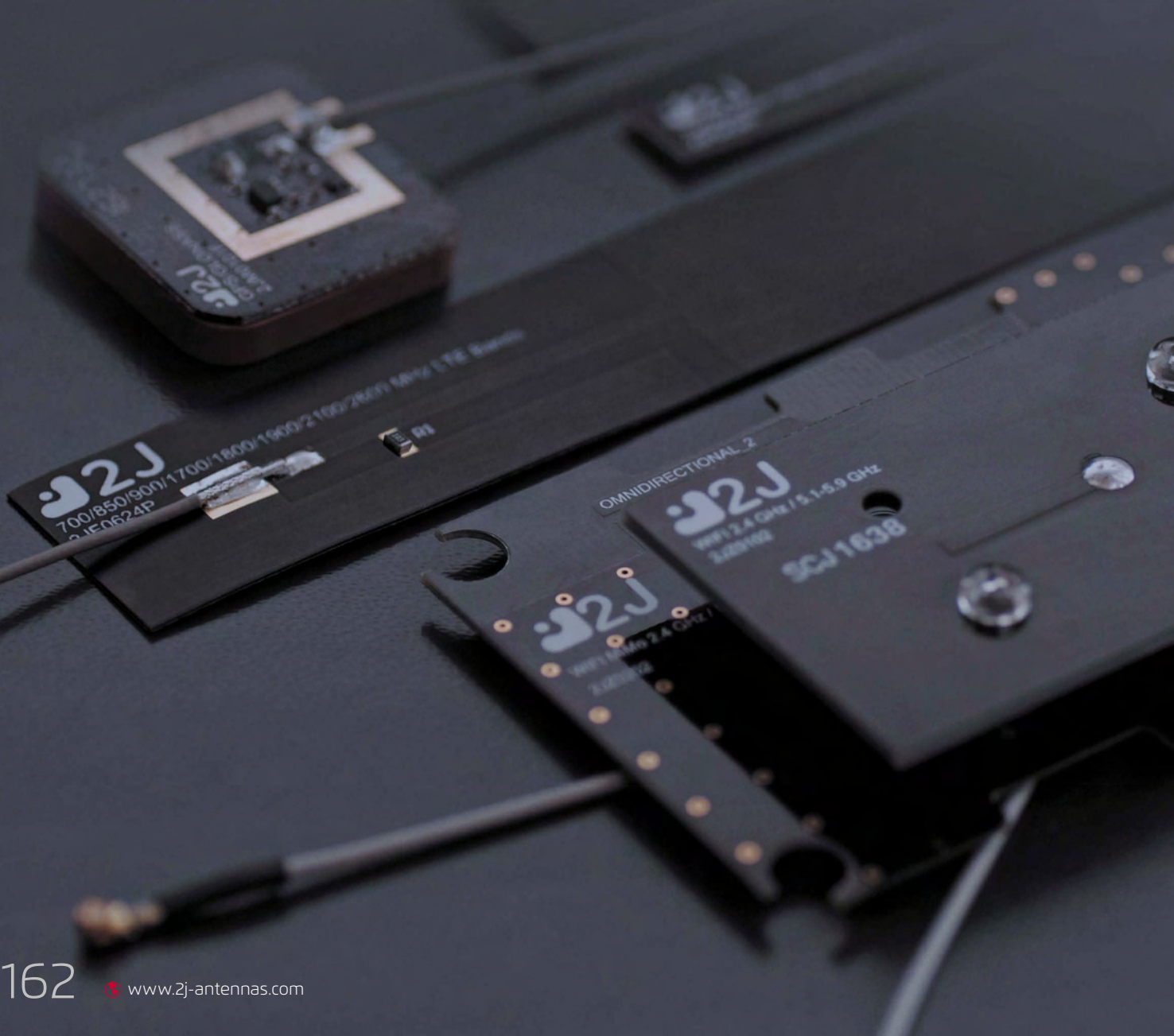

2JF0624P Antenna

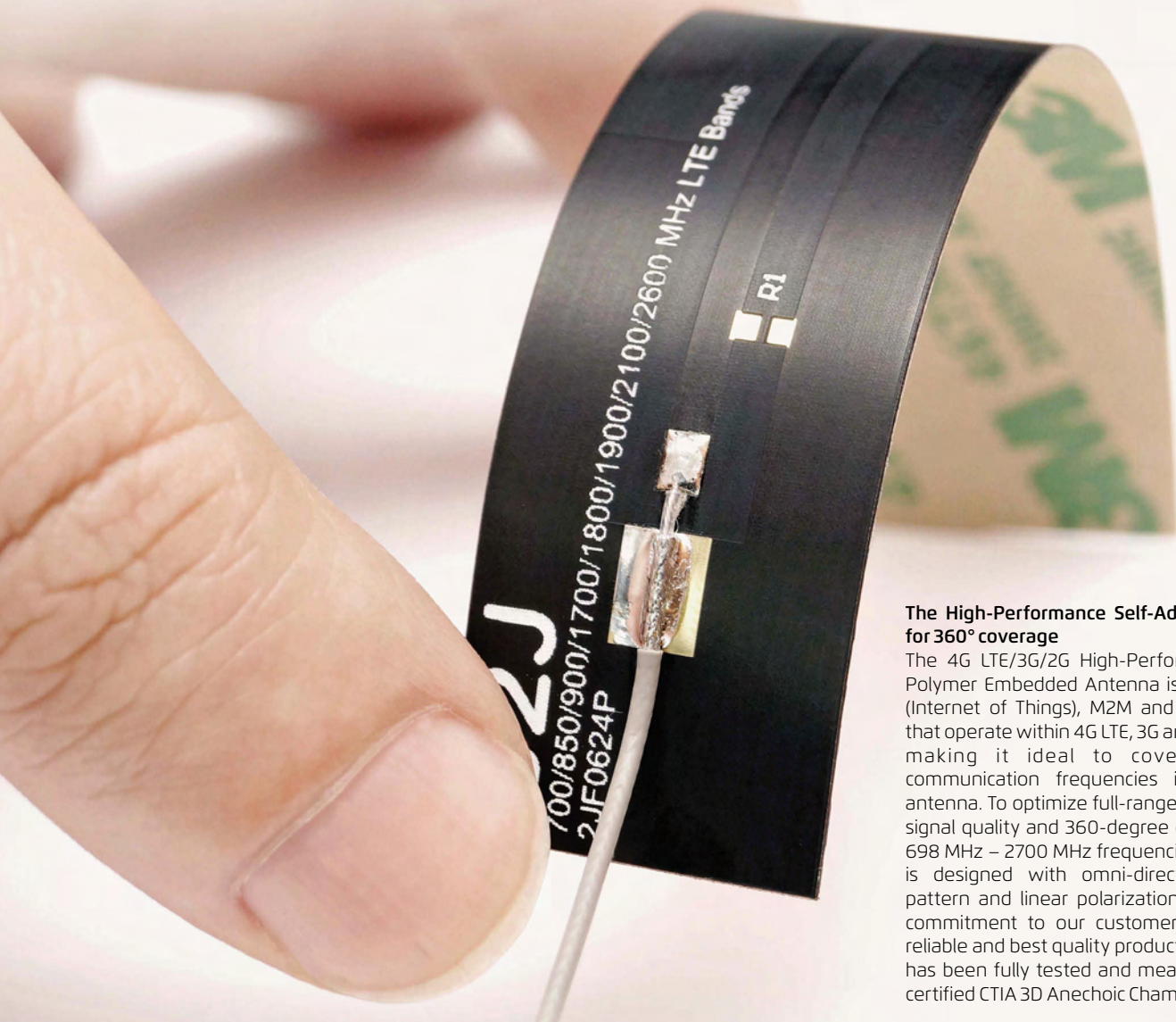

The High-Performance Self-Adhesive Solution for 360° coverage

The 4G LTE/3G/2G High-Performance Flexible Polymer Embedded Antenna is suitable for IoT (Internet of Things), M2M and mobile devices that operate within 4G LTE, 3G and 2G standards, making it ideal to cover all cellular communication frequencies in one unique antenna. To optimize full-range signal strength, signal quality and 360-degree coverage within 698 MHz – 2700 MHz frequencies, this antenna is designed with omni-directional radiation pattern and linear polarization. To assure our commitment to our customers for the most reliable and best quality products, the 2JF0624P has been fully tested and measured using our certified CTIA 3D Anechoic Chamber.

The 2JF0624P is the most advanced solution for high throughput demanding platform applications relating but not limited to IoT, cellular data, voice and video streaming devices. Higher bandwidth requirements are necessary for today's demanding development of high-performance devices found in commercial, industrial and residential industries. Across all bands, the peak gains range between ~1.0 – ~3.4 dBi and confidently maintains efficiency between 59% - 68% bringing optimal range with superior efficiency. This antenna comes with a standard U.FL connector type, 150 mm cable length and 1.37 mm Mini-Coax cable. Antenna is fully customizable with alternative connectors, cables and lengths. The 2JF0624P is the optimal choice for device manufacturers that rely on cost-efficient LTE antenna solutions and durability for a long device life cycle.

Installation / Environmental

The flexible polymer material and low-profile dimensions of 110.4 x 20.8 x 0.2 mm give the ultra-thin antenna versatile installation options. With ground plane independence and adhesive mount, this antenna can be installed with easy “peel and stick” on glass and plastic surfaces in the most unique devices spaces, giving design engineers a new perspective on design possibilities. The production-grade polymer allows full antenna operation in extreme temperatures ranging between -40°C and +85°C.

2J Antennas supports environmental health and manufactures all our products without hazardous materials that could potentially harm the environment making us fully RoHS and REACH compliant.



2JF0424P

4GLTE/FirstNet/LPWA/NB-IoT/3G/2G

Key Features High Performance Ground Plane Independent Customizable Cable and Connector Flexible Self-Adhesive Embedded Antenna



Black

Standard colors.
Other colors upon request.

General specification

Mounting type	Adhesive mount Flexible
Dimensions (mm)	136.8 × 32.6 × 0.2
Operating temperature	-40 °C to +85 °C

Antenna and electrical specifications 4GLTE/FirstNet/LPWA/NB-IoT/3G/2G

Standards	4GLTE/FirstNet/LPWA/ CAT-X/CAT-Mx/CAT-NBx/NB-IoT/3G/2G
Frequency (MHz)	698-960, 1710-2170, 2500-2700
VSWR	~1.7:1, ~1.1:1, ~1.7:1
Efficiency (%)	~58, ~74, ~61
Peak Gain (dBi)	~1.5, ~3.1, ~3.5
Impedance (Ohm)	50
Polarisation	Linear
Radiation Pattern	Omni-Directional
Max. Input Power (W)	25

2JF0624P

4GLTE/FirstNet/LPWA/NB-IoT/3G/2G

Key Features High Performance Ground Plane Independent Customizable Cable and Connector Flexible Self-Adhesive Embedded Antenna



Black

Standard colors.
Other colors upon request.



General specification

Mounting type	Adhesive mount Flexible
Dimensions (mm)	110.4 × 20.8 × 0.2
Operating temperature	-40 °C to +85 °C

Antenna and electrical specifications 4GLTE/FirstNet/LPWA/NB-IoT/3G/2G

Standards	4GLTE/FirstNet/LPWA/ CAT-X/CAT-Mx/CAT-NBx/NB-IoT/3G/2G
Frequency (MHz)	698-960, 1710-2170, 2500-2700
VSWR	~1.6:1, ~2.0:1, ~2.8:1
Efficiency (%)	~59, ~68, ~59
Peak Gain (dBi)	~1.0, ~3.4, ~2.5
Impedance (Ohm)	50
Polarisation	Linear
Radiation Pattern	Omni-Directional
Max. Input Power (W)	25

2JF0924P

4GLTE/FirstNet/LPWA/NB-IoT/3G/2G

Key Features High Performance Ground Plane Independent Customizable Cable and Connector Flexible Self-Adhesive Embedded Antenna



Black

Standard colors.
Other colors upon request.



General specification

Mounting type	Adhesive mount Flexible
Dimensions (mm)	120 × 8.9 × 0.15
Operating temperature	-40 °C to +85 °C

Antenna and electrical specifications 4GLTE/FirstNet/LPWA/NB-IoT/3G/2G

Standards	4GLTE/FirstNet/LPWA/ CAT-X/CAT-Mx/CAT-NBx/NB-IoT/3G/2G
Frequency (MHz)	698-960, 1710-2170, 2500-2700
VSWR	~2.5:1, ~2.4:1, ~2.3:1
Efficiency (%)	~50.3, ~50, ~58.8
Peak Gain (dBi)	~0.2, ~2.2, ~4.5
Impedance (Ohm)	50
Polarisation	Linear
Radiation Pattern	Omni-Directional
Max. Input Power (W)	25



2JF0304P 3G/2G/CELLULAR

Key Features High Performance Ground Plane Independent Customizable Cable and Connector Flexible Self-Adhesive Embedded Antenna



Black

Standard colors.
Other colors upon request.

General specification

Mounting type	Adhesive mount Flexible
Dimensions (mm)	70.4 × 26.4 × 0.1
Operating temperature	-40 °C to +85 °C

Antenna and electrical specifications 3G/2G/CELLULAR

Standards	3G/Cellular/HSPA/UMTS/WCDA/ EDGE/EGPRS/GRPS/GSM/CDMA/2G
Frequency (MHz)	824-960, 1710-2170
VSWR	~2.4:1, ~1.5:1
Efficiency (%)	~41, ~61
Peak Gain (dBi)	~1.0, ~2.1
Impedance (Ohm)	50
Polarisation	Linear
Radiation Pattern	Omni-Directional
Max. Input Power (W)	25

2JF0604P 3G/2G/CELLULAR

Key Features High Performance Ground Plane Independent Customizable Cable and Connector Flexible Self-Adhesive Embedded Antenna



Black

Standard colors.
Other colors upon request.

General specification

Mounting type	Adhesive mount Flexible
Dimensions (mm)	74.9 × 8.1 × 0.1
Operating temperature	-40 °C to +85 °C

Antenna and electrical specifications 3G/2G/CELLULAR

Standards	3G/Cellular/HSPA/UMTS/WCDA/ EDGE/EGPRS/GRPS/GSM/CDMA/2G
Frequency (MHz)	824-960, 1710-2170
VSWR	~2.4:1, ~1.6:1
Efficiency (%)	~40.2, ~67.8
Peak Gain (dBi)	~0.7, ~0.7
Impedance (Ohm)	50
Polarisation	Linear
Radiation Pattern	Omni-Directional
Max. Input Power (W)	25

2JF0102P 2.4-5.0GHz/WiFi/LPWA/BT/ISM

Key Features High Performance Ground Plane Independent Customizable Cable and Connector Flexible Self-Adhesive Embedded Antenna



Black

Standard colors.
Other colors upon request.

General specification

Mounting type	Adhesive mount Flexible
Dimensions (mm)	39.6x 8.4 × 0.1
Operating temperature	-40 °C to +85 °C

Antenna and electrical specifications 2.4-5.0GHz/WiFi/LPWA/BT/ISM

Standards	WiFi/Sigfox/LoRa/LPWA/Bluetooth/ BLE/ZigBee/RFID/RFMA/ISM
Frequency (MHz)	2410-2490, 4920-5925
VSWR	~1.2:1, ~1.4:1
Efficiency (%)	~76, ~82
Peak Gain (dBi)	~2.2, ~3.8
Impedance (Ohm)	50
Polarisation	Linear
Radiation Pattern	Omni-Directional
Max. Input Power (W)	25



2JF0102Pa

2.4-5.0GHz/WiFi/LPWA/BT/ISM

Key Features High Performance Ground Plane Independent Customizable Cable and Connector Flexible Self-Adhesive Embedded Antenna



Black

Standard colors.
Other colors upon request.

General specification

Mounting type	Adhesive mount Flexible
Dimensions (mm)	67.5 × 25.0 × 0.15
Operating temperature	-40 °C to +85 °C

Antenna and electrical specifications 2.4-5.0GHz/WiFi/LPWA/BT/ISM

Standards	WiFi/Sigfox/LoRa/LPWA/Bluetooth/ BLE/ZigBee/RFID/RFMA/ISM
Frequency (MHz)	2410-2490, 4920-5925
VSWR	~1.2:1, ~1.4:1
Efficiency (%)	~76, ~82
Peak Gain (dBi)	~2.2, ~3.8
Impedance (Ohm)	50
Polarisation	Linear
Radiation Pattern	Omni-Directional
Max. Input Power (W)	25

2JF0202P

2.4-5.0GHz/WiFi/LPWA/BT/ISM

Key Features High Performance Ground Plane Independent Customizable Cable and Connector Flexible Self-Adhesive Embedded Antenna

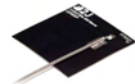

Black

Standard colors.
Other colors upon request.

General specification

Mounting type	Adhesive mount Flexible
Dimensions (mm)	30 × 30 × 0.2
Operating temperature	-40 °C to +85 °C

Antenna and electrical specifications 2.4-5.0GHz/WiFi/LPWA/BT/ISM

Standards	WiFi/Sigfox/LoRa/LPWA/Bluetooth/ BLE/ZigBee/RFID/RFMA/ISM
Frequency (MHz)	2410-2490, 4920-5925
VSWR	~1.2:1, ~1.5:1
Efficiency (%)	~76.3, ~74.7
Peak Gain (dBi)	~4.4, ~6.7
Impedance (Ohm)	50
Polarisation	Linear
Radiation Pattern	Omni-Directional
Max. Input Power (W)	25

2JF0115P

868MHz/Sigfox/LoRa/LPWA/RFID/ZigBee/ISM

Key Features Ground Plane Independent Customizable Cable and Connector Flexible Self-Adhesive Embedded Antenna



Black

Standard colors.
Other colors upon request.

General specification

Mounting type	Adhesive mount Flexible
Dimensions (mm)	40.0 × 7.0 × 0.2
Operating temperature	-40 °C to +85 °C

Antenna and electrical specifications 868MHz/Sigfox/LoRa/LPWA/RFID/ZigBee/ISM

Standards	Sigfox/LoRa/ZigBee/RFID/LPWA/ISM/UHF
Frequency (MHz)	863-870
VSWR	~1.9:1
Efficiency (%)	~32.7
Peak Gain (dBi)	~0.8
Impedance (Ohm)	50
Polarisation	Linear
Radiation Pattern	Omni-Directional
Max. Input Power (W)	25



2JF0215P

915MHz/Sigfox/LoRa/LPWA/RFID/ZigBee/ISM

Key Features ✓ Ground Plane Independent ✓ Customizable Cable and Connector ✓ Flexible Self-Adhesive Embedded Antenna



Black

Standard colors.
Other colors upon request.

General specification

Mounting type	Adhesive mount Rigid
Dimensions (mm)	40.0 × 7.0 × 0.2
Operating temperature	-40 °C to +85 °C

Antenna and electrical specifications

915MHz/Sigfox/LoRa/LPWA/RFID/ZigBee/ISM

Standards	Sigfox/LoRa/ZigBee/RFID/LPWA/ISM/UHF
Frequency (MHz)	902-928
VSWR	~1.6:1
Efficiency (%)	~38.7
Peak Gain (dBi)	~0.1
Impedance (Ohm)	50
Polarisation	Linear
Radiation Pattern	Omni-Directional
Max. Input Power (W)	25

2JF0515P

915MHz/Sigfox/LoRa/LPWA/RFID/ZigBee/ISM

Key Features ✓ Ground Plane Independent ✓ Customizable Cable and Connector ✓ Flexible Self-Adhesive Embedded Antenna



Black

Standard colors.
Other colors upon request.

General specification

Mounting type	Adhesive mount Rigid
Dimensions (mm)	39.9 × 7.0 × 0.2
Operating temperature	-40 °C to +85 °C

Antenna and electrical specifications

915MHz/Sigfox/LoRa/LPWA/RFID/ZigBee/ISM

Standards	Sigfox/LoRa/ZigBee/RFID/LPWA/ISM/UHF
Frequency (MHz)	902-928
VSWR	~1.3:1
Efficiency (%)	~33.6
Peak Gain (dBi)	~0.3
Impedance (Ohm)	50
Polarisation	Linear
Radiation Pattern	Omni-Directional
Max. Input Power (W)	25

2JF0415P

868-915MHz/Sigfox/LoRa/LPWA/RFID/ZigBee/ISM

Key Features ✓ High Performance ✓ Ground Plane Independent ✓ Customizable Cable and Connector ✓ Flexible Self-Adhesive Embedded Antenna
✓ Dual Band 868/915 MHz ISM Antenna

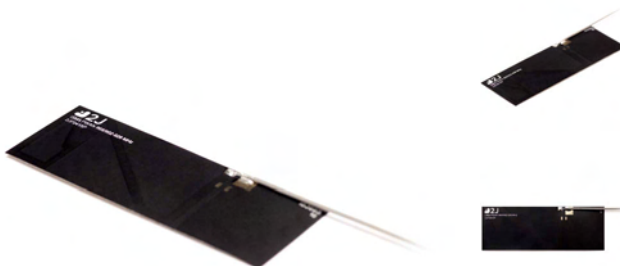

Black

Standard colors.
Other colors upon request.

General specification

Mounting type	Adhesive mount Rigid
Dimensions (mm)	25 × 70 × 0.2
Operating temperature	-40 °C to +85 °C

Antenna and electrical specifications

868-915MHz/Sigfox/LoRa/LPWA/RFID/ZigBee/ISM

Standards	Sigfox/LoRa/ZigBee/RFID/LPWA/ISM/UHF
Frequency (MHz)	863-870, 902-928
VSWR	~2.3:1, ~1.2:1
Efficiency (%)	~58, ~77
Peak Gain (dBi)	~2.7, ~3.6
Impedance (Ohm)	50
Polarisation	Linear
Radiation Pattern	Omni-Directional
Max. Input Power (W)	25



2JP0124P

4GLTE/FirstNet/LPWA/NB-IoT/3G/2G

Key Features High Performance Ground Plane Independent Customizable Cable and Connector Rigid Self-Adhesive Embedded Antenna



Black

Standard colors.
Other colors upon request.

General specification

Mounting type	Adhesive mount Rigid
Dimensions (mm)	136.8 × 32.6 × 0.4
Operating temperature	-40 °C to +85 °C

Antenna and electrical specifications 4GLTE/FirstNet/LPWA/NB-IoT/3G/2G

Standards	4GLTE/FirstNet/LPWA/ CAT-X/CAT-Mx/CAT-NBx/NB-IoT/3G/2G
Frequency (MHz)	698-960, 1710-2170, 2500-2700
VSWR	~1.7:1, ~1.1:1, ~1.7:1
Efficiency (%)	~58, ~74, ~61
Peak Gain (dBi)	~1.5, ~3.1, ~3.5
Impedance (Ohm)	50
Polarisation	Linear
Radiation Pattern	Omni-Directional
Max. Input Power (W)	25

2JP0224P

4GLTE/FirstNet/LPWA/NB-IoT/3G/2G

Key Features High Performance Ground Plane Independent Customizable Cable and Connector Rigid Self-Adhesive Embedded Antenna



Black

Standard colors.
Other colors upon request.

General specification

Mounting type	Adhesive mount Rigid
Dimensions (mm)	115.3 × 19.7 × 0.8
Operating temperature	-40 °C to +85 °C

Antenna and electrical specifications 4GLTE/FirstNet/LPWA/NB-IoT/3G/2G

Standards	4GLTE/FirstNet/LPWA/ CAT-X/CAT-Mx/CAT-NBx/NB-IoT/3G/2G
Frequency (MHz)	698-960, 1710-2170
VSWR	~1.7:1, ~1.6:1
Efficiency (%)	~52, ~56
Peak Gain (dBi)	~0.8, ~2.7
Impedance (Ohm)	50
Polarisation	Linear
Radiation Pattern	Omni-Directional
Max. Input Power (W)	25

2JP0424P

4GLTE/FirstNet/LPWA/NB-IoT/3G/2G

Key Features High Performance Ground Plane Independent Customizable Cable and Connector Rigid Self-Adhesive Embedded Antenna



Black

Standard colors.
Other colors upon request.

General specification

Mounting type	Adhesive mount Rigid
Dimensions (mm)	113 × 8.5 × 0.8
Operating temperature	-40 °C to +85 °C

Antenna and electrical specifications 4GLTE/FirstNet/LPWA/NB-IoT/3G/2G

Standards	4GLTE/FirstNet/LPWA/ CAT-X/CAT-Mx/CAT-NBx/NB-IoT/3G/2G
Frequency (MHz)	698-960, 1710-2170, 2500-2700
VSWR	~3.4:1, ~2.6:1, ~1.9:1
Efficiency (%)	~56, ~66, ~78
Peak Gain (dBi)	~1.2, ~4.0, ~5.6
Impedance (Ohm)	50
Polarisation	Linear
Radiation Pattern	Omni-Directional
Max. Input Power (W)	25

2JP0524P

4GLTE/FirstNet/LPWA/NB-IoT/3G/2G

Key Features  High Performance  Ground Plane Independent  Customizable Cable and Connector  Rigid Self-Adhesive Embedded Antenna



Black

Standard colors.
Other colors upon request.

General specification

Mounting type	Adhesive mount Rigid
Dimensions (mm)	126 × 13.6 × 0.8
Operating temperature	-40 °C to +85 °C

Antenna and electrical specifications

4GLTE/FirstNet/LPWA/NB-IoT/3G/2G

Standards	4GLTE/FirstNet/LPWA/ CAT-X/CAT-Mx/CAT-NBx/NB-IoT/3G/2G
Frequency (MHz)	698-960, 1710-2170, 2500-2700
VSWR	~1.9:1, ~1.6:1, ~1.4:1
Efficiency (%)	~50, ~53, ~60
Peak Gain (dBi)	~-0.8, ~2.2, ~2.0
Impedance (Ohm)	50
Polarisation	Linear
Radiation Pattern	Omni-Directional
Max. Input Power (W)	25

2JP0624P

4GLTE/FirstNet/LPWA/NB-IoT/3G/2G

Key Features  High Performance  Ground Plane Independent  Customizable Cable and Connector  Rigid Self-Adhesive Embedded Antenna



Black

Standard colors.
Other colors upon request.

General specification

Mounting type	Adhesive mount Rigid
Dimensions (mm)	89.7 × 14.1 × 0.8
Operating temperature	-40 °C to +85 °C

Antenna and electrical specifications

4GLTE/FirstNet/LPWA/NB-IoT/3G/2G

Standards	4GLTE/FirstNet/LPWA/ CAT-X/CAT-Mx/CAT-NBx/NB-IoT/3G/2G
Frequency (MHz)	698-960, 1710-2170, 2500-2700
VSWR	~1.5:1, ~1.8:1, ~2.1:1
Efficiency (%)	~45, ~48, ~48
Peak Gain (dBi)	~-0.3, ~1.5, ~2.8
Impedance (Ohm)	50
Polarisation	Linear
Radiation Pattern	Omni-Directional
Max. Input Power (W)	25

2JP0104P

3G/2G/CELLULAR

Key Features  High Performance  Ground Plane Independent  Customizable Cable and Connector  Rigid Self-Adhesive Embedded Antenna



Black

Standard colors.
Other colors upon request.

General specification

Mounting type	Adhesive mount Rigid
Dimensions (mm)	75 × 25 × 0.8
Operating temperature	-40 °C to +85 °C

Antenna and electrical specifications

3G/2G/CELLULAR

Standards	3G/Cellular/HSPA/UMTS/WCDA/ EDGE/EGPRS/GRPS/GSM/CDMA/2G
Frequency (MHz)	824-960, 1710-2170
VSWR	~2.1:1, ~2.6:1
Efficiency (%)	~45, ~60
Peak Gain (dBi)	~-0.5, ~3.0
Impedance (Ohm)	50
Polarisation	Linear
Radiation Pattern	Omni-Directional
Max. Input Power (W)	25



2JP0704P 3G/2G/CELLULAR

Key Features High Performance Ground Plane Independent Customizable Cable and Connector Rigid Self-Adhesive Embedded Antenna



Black

Standard colors.
Other colors upon request.

General specification

Mounting type	Adhesive mount Rigid
Dimensions (mm)	75 × 8.1 × 0.8
Operating temperature	-40 °C to +85 °C

Antenna and electrical specifications 3G/2G/CELLULAR

Standards	3G/Cellular/HSPA/UMTS/WCDA/ EDGE/EGPRS/GRPS/GSM/CDMA/2G
Frequency (MHz)	824-960, 1710-2170
VSWR	~2.5:1, ~1.7:1
Efficiency (%)	~32.6, ~39.1
Peak Gain (dBi)	~-1.3, ~-1.3
Impedance (Ohm)	50
Polarisation	Linear
Radiation Pattern	Omni-Directional
Max. Input Power (W)	25

2JP0102P 2.4-5.0GHz/WiFi/LPWA/BT/ISM

Key Features High Performance Ground Plane Independent Customizable Cable and Connector Rigid Self-Adhesive Embedded Antenna



Black

Standard colors.
Other colors upon request.

General specification

Mounting type	Adhesive mount Rigid
Dimensions (mm)	16.4 × 5.4 × 0.4
Operating temperature	-40 °C to +85 °C

Antenna and electrical specifications 2.4-5.0GHz/WiFi/LPWA/BT/ISM

Standards	WiFi/Sigfox/LoRa/LPWA/Bluetooth/ BLE/ZigBee/RFID/RFMA/ISM
Frequency (MHz)	2410-2490, 4920-5925
VSWR	~2.4:1, ~2.2:1
Efficiency (%)	~53, ~64
Peak Gain (dBi)	~-3.2, ~-5.0
Impedance (Ohm)	50
Polarisation	Linear
Radiation Pattern	Omni-Directional
Max. Input Power (W)	10

2JP0615P 433MHz/LPWA/RFID/ZigBee/ISM

Key Features High Performance Ground Plane Independent Customizable Cable and Connector Rigid Self-Adhesive Embedded Antenna



Black

Standard colors.
Other colors upon request.

General specification

Mounting type	Adhesive mount Rigid
Dimensions (mm)	58.7 × 157.6 × 14.4
Operating temperature	-40 °C to +85 °C

Antenna and electrical specifications 433MHz/LPWA/RFID/ZigBee/ISM

Standards	Sigfox/LoRa/RFID/LPWA/ISM/UHF
Frequency (MHz)	433-435
VSWR	~1.8:1
Efficiency (%)	~36
Peak Gain (dBi)	~-2.4
Impedance (Ohm)	50
Polarisation	Linear
Radiation Pattern	Omni-Directional
Max. Input Power (W)	25

2JP0115P

868MHz/Sigfox/LoRa/LPWA/RFID/ZigBee/ISM

Key Features  Ground Plane Independent  Customizable Cable and Connector  Rigid Self-Adhesive Embedded Antenna



Black

Standard colors.
Other colors upon request.

General specification

Mounting type	Adhesive mount Rigid
Dimensions (mm)	35.0 × 6.5 × 0.8
Operating temperature	-40 °C to +85 °C

Antenna and electrical specifications

868MHz/Sigfox/LoRa/LPWA/RFID/ZigBee/ISM

Standards	Sigfox/LoRa/ZigBee/RFID/LPWA/ISM/UHF
Frequency (MHz)	863-870
VSWR	~3.0:1
Efficiency (%)	~29.0
Peak Gain (dBi)	~-1.4
Impedance (Ohm)	50
Polarisation	Linear
Radiation Pattern	Omni-Directional
Max. Input Power (W)	25

2JP0215P

915MHz/Sigfox/LoRa/LPWA/RFID/ZigBee/ISM

Key Features  Ground Plane Independent  Customizable Cable and Connector  Rigid Self-Adhesive Embedded Antenna



Black

Standard colors.
Other colors upon request.

General specification

Mounting type	Adhesive mount Rigid
Dimensions (mm)	35.0 × 6.5 × 0.8
Operating temperature	-40 °C to +85 °C

Antenna and electrical specifications

915MHz/Sigfox/LoRa/LPWA/RFID/ZigBee/ISM

Standards	Sigfox/LoRa/ZigBee/RFID/LPWA/ISM/UHF
Frequency (MHz)	902-928
VSWR	~1.7:1
Efficiency (%)	~36.0
Peak Gain (dBi)	~-0.4
Impedance (Ohm)	50
Polarisation	Linear
Radiation Pattern	Omni-Directional
Max. Input Power (W)	25

2JP0515P

915MHz/Sigfox/LoRa/LPWA/RFID/ZigBee/ISM

Key Features  Ground Plane Independent  Customizable Cable and Connector  Rigid Self-Adhesive Embedded Antenna



Black

Standard colors.
Other colors upon request.

General specification

Mounting type	Adhesive mount Rigid
Dimensions (mm)	35.4 × 6.8 × 0.8
Operating temperature	-40 °C to +85 °C

Antenna and electrical specifications

915MHz/Sigfox/LoRa/LPWA/RFID/ZigBee/ISM

Standards	Sigfox/LoRa/ZigBee/RFID/LPWA/ISM/UHF
Frequency (MHz)	902-928
VSWR	~1.3:1
Efficiency (%)	~32.5
Peak Gain (dBi)	~-0.1
Impedance (Ohm)	50
Polarisation	Linear
Radiation Pattern	Omni-Directional
Max. Input Power (W)	25



2JE19 Brick Antenna

4GLTE/FirstNet/LPWA/NB-IoT/3G/2G

Key Features High Performance Ground Plane Dependent Ceramic Material Compact size Easy to Integrate

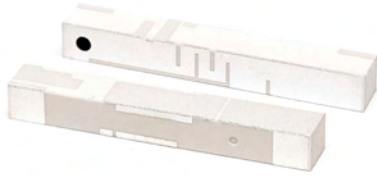

General specification

Mounting type	Surface mount Ceramic
Dimensions (mm)	40 × 5 × 6
Operating temperature	-40 °C to +85 °C

Antenna and electrical specifications

4GLTE/FirstNet/LPWA/NB-IoT/3G/2G

Standards	4GLTE/FirstNet/LPWA/ CAT-X/CAT-Mx/CAT-NBx/NB-IoT/3G/2G
Frequency (MHz)	698-960, 1710-2170, 2500-2700
VSWR	~2.7:1, ~2.0:1, ~2.1:1
Efficiency (%)	~49.3, ~67.1, ~59.4
Peak Gain (dBi)	~0.9, ~3.9, ~-3.6
Impedance (Ohm)	50
Polarisation	Linear
Radiation Pattern	Omni-Directional
Max. Input Power (W)	25

2JE20 Brick Antenna

4GLTE/FirstNet/LPWA/NB-IoT/3G/2G

Key Features High Performance Ground Plane Dependent Ceramic Material Compact size Easy to Integrate

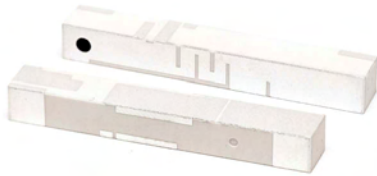

General specification

Mounting type	Surface mount Ceramic
Dimensions (mm)	35 × 5 × 4
Operating temperature	-40 °C to +85 °C

Antenna and electrical specifications

4GLTE/FirstNet/LPWA/NB-IoT/3G/2G

Standards	4GLTE/FirstNet/LPWA/ CAT-X/CAT-Mx/CAT-NBx/NB-IoT/3G/2G
Frequency (MHz)	698-960, 1710-2170, 2500-2700
VSWR	~3.0:1, ~3.0:1, ~1.4:1
Efficiency (%)	~43.1, ~53.7, ~72.6
Peak Gain (dBi)	~0.3, ~3.0, ~4.8
Impedance (Ohm)	50
Polarisation	Linear
Radiation Pattern	Omni-Directional
Max. Input Power (W)	25

2JS01 Passive Patch GNSS

GPS/GLONASS/QZSS/Galileo/L1

Key Features High Performance Ground Plane Dependent Ceramic Material Compact size Easy to Integrate



General specification

Mounting type	Surface mount Ceramic
Dimensions (mm)	13 × 13 × 4
Operating temperature	-40 °C to +85 °C

Antenna and electrical specifications

GPS/GLONASS/QZSS/Galileo/L1

Standards	GPS(L1)/GLONASS(L10F)/QZSS(L1)/Galileo(E1)
Frequency (MHz)	1575.42, 1598-1606
VSWR	~1.4:1, ~1.4:1
Efficiency (%)	~58.9, ~58.3
Peak Gain (dBi)	~3.5, ~3.5
Impedance (Ohm)	50
Radiation Pattern	Hemispherical
Polarisation	RHCP



2JS10 Passive Patch GNSS

GPS/GLONASS/QZSS/Galileo/L1

Key Features High Performance Ground Plane Dependent Ceramic Material Compact size Easy to Integrate



General specification

Mounting type	Surface mount Ceramic
Dimensions (mm)	18 × 18 × 4
Operating temperature	-40 °C to +85 °C

Antenna and electrical specifications

GPS/GLONASS/QZSS/Galileo/L1	
Standards	GPS(L1)/GLONASS(L10F)/QZSS(L1)/Galileo(E1)
Frequency (MHz)	1575.42, 1598-1606
VSWR	~1.2:1, ~1.1:1
Efficiency (%)	~76.4, ~74.4
Peak Gain (dBi)	~4.3, ~4.4
Impedance (Ohm)	50
Radiation Pattern	Hemispherical
Polarisation	RHCP

2JS20 Passive Patch GNSS

GPS/GLONASS/QZSS/Galileo/L1

Key Features High Performance Ground Plane Dependent Ceramic Material Compact size Easy to Integrate



General specification

Mounting type	Surface mount Ceramic
Dimensions (mm)	25 × 25 × 4
Operating temperature	-40 °C to +85 °C

Antenna and electrical specifications

GPS/GLONASS/QZSS/Galileo/L1	
Standards	GPS(L1)/GLONASS(L10F)/QZSS(L1)/Galileo(E1)
Frequency (MHz)	1575.42, 1598-1606
VSWR	~1.1:1, ~1.1:1
Efficiency (%)	~84.2, ~80.9
Peak Gain (dBi)	~4.6, ~4.7
Impedance (Ohm)	50
Radiation Pattern	Hemispherical
Polarisation	RHCP

2JE08a Passive GNSS Monopole Antenna

GPS/GLONASS/BEIDOU/QZSS/Galileo/L1

Key Features Ground Plane Dependent Ceramic Material Compact size Easy to Integrate



General specification

Mounting type	Surface mount Ceramic
Dimensions (mm)	8 × 1.7 × 1
Operating temperature	-40 °C to +85 °C

Antenna and electrical specifications

GPS/GLONASS/BEIDOU/QZSS/Galileo/L1 (Connection 1)	
Standards	GPS(L1)/GLONASS(L10F)/BeiDou(B1)/QZSS(L1)/Galileo(E1)
Frequency (MHz)	1561.098, 1575.42, 1598-1606
VSWR	~1.7:1, ~1.5:1, ~1.6:1
Efficiency (%)	~55.5, ~56.9, ~55.8
Peak Gain (dBi)	~1.0, ~1.1, ~1.3
Impedance (Ohm)	50
Polarisation	Linear
Radiation Pattern	Hemispherical



2JL60 Passive GNSS Loop Antenna

GPS/GLONASS/BEIDOU/QZSS/Galileo/L1

Key Features Ground Plane Dependent Ceramic Material Compact size Easy to Integrate

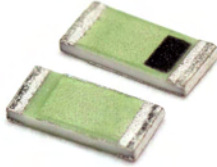

General specification

Mounting type	Surface mount Ceramic
Dimensions (mm)	3.2 × 1.6 × 0.5
Operating temperature	-40 °C to +85 °C

Antenna and electrical specifications

GPS/GLONASS/BEIDOU/QZSS/Galileo/L1 (Connection 1)

Standards	GPS(L1)/GLONASS(L10F)/BeiDou(B1)/QZSS(L1)/Galileo(E1)
Frequency (MHz)	1561.098, 1575.42, 1598-1606
VSWR	~1.6:1, ~1.2:1, ~1.5:1
Efficiency (%)	~64.6, ~67.2, ~61.1
Peak Gain (dBi)	~1.7, ~2.3, ~1.8
Impedance (Ohm)	50
Polarisation	Linear
Radiation Pattern	Omni-Directional

2JE07g Monopole Antenna

2.4GHz/WiFi/LPWA/BT/ISM

Key Features Ground Plane Dependent Ceramic Material Compact size Easy to Integrate



General specification

Mounting type	Surface mount Ceramic
Dimensions (mm)	5.3 × 2 × 1.3
Operating temperature	-40 °C to +85 °C

Antenna and electrical specifications

2.4GHz/WiFi/LPWA/BT/ISM (Connection 1)

Standards	WiFi/Sigfox/LoRa/LPWA/Bluetooth/BLE/ZigBee/RFID/MPMA/ISM
Frequency (MHz)	2410-2490
VSWR	~1.2:1
Efficiency (%)	~67
Peak Gain (dBi)	~3.2
Impedance (Ohm)	50
Polarisation	Linear
Radiation Pattern	Omni-Directional
Max. Input Power (W)	25

2JL30 Loop Antenna

2.4GHz/WiFi/LPWA/BT/ISM

Key Features Ground Plane Dependent Ceramic Material Compact size Easy to Integrate

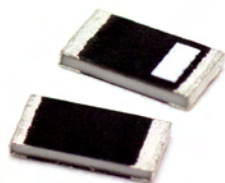

General specification

Mounting type	Surface mount Ceramic
Dimensions (mm)	3.2 × 1.6 × 0.5
Operating temperature	-40 °C to +85 °C

Antenna and electrical specifications

2.4GHz/WiFi/LPWA/BT/ISM (Connection 1)

Standards	WiFi/Sigfox/LoRa/LPWA/Bluetooth/BLE/ZigBee/RFID/MPMA/ISM
Frequency (MHz)	2410-2490
VSWR	~1.3:1
Efficiency (%)	~63.3
Peak Gain (dBi)	~1.1
Impedance (Ohm)	50
Polarisation	Linear
Radiation Pattern	Omni-Directional
Max. Input Power (W)	25



2JS30 Surface Mount Antenna

2.4GHz/WiFi/LPWA/BT/ISM

Key Features High Performance Ground Plane Dependent Ceramic Material Compact size Easy to Integrate



General specification

Mounting type	Surface mount Ceramic
Dimensions (mm)	13 × 13 × 4
Operating temperature	-40 °C to +85 °C

Antenna and electrical specifications

2.4GHz/WiFi/LPWA/BT/ISM (Connection 1)

Standards	WiFi/Sigfox/LoRa/LPWA/Bluetooth/ BLE/ZigBee/RFID/RFMA/ISM
Frequency (MHz)	2410-2490
VSWR	~2.5:1
Efficiency (%)	~60.3
Peak Gain (dBi)	~4.2
Impedance (Ohm)	50
Polarisation	Linear
Radiation Pattern	Hemispherical

2JE07i Monopole Antenna

5.0GHz/WiFi/ISM

Key Features Ground Plane Dependent Ceramic Material Compact size Easy to Integrate

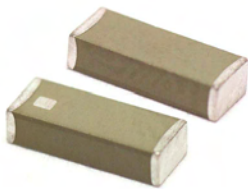

General specification

Mounting type	Surface mount Ceramic
Dimensions (mm)	5.2 × 2 × 1.2
Operating temperature	-40 °C to +85 °C

Antenna and electrical specifications

5.0GHz/WiFi/ISM (Connection 1)

Standards	WiFi/ISM
Frequency (MHz)	4920-5925
VSWR	~2.1:1
Efficiency (%)	~55.9
Peak Gain (dBi)	~2.1
Impedance (Ohm)	50
Polarisation	Linear
Radiation Pattern	Omni-Directional
Max. Input Power (W)	10

2JL50 Loop Antenna

5.0GHz/WiFi/ISM

Key Features Ground Plane Dependent Ceramic Material Compact size Easy to Integrate

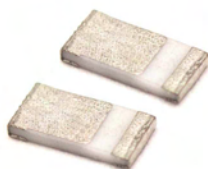

General specification

Mounting type	Surface mount Ceramic
Dimensions (mm)	3.2 × 1.6 × 0.5
Operating temperature	-40 °C to +85 °C

Antenna and electrical specifications

5.0GHz/WiFi/ISM (Connection 1)

Standards	WiFi/ISM
Frequency (MHz)	4920-5925
VSWR	~2.0:1
Efficiency (%)	~54.7
Peak Gain (dBi)	~0.9
Impedance (Ohm)	50
Polarisation	Linear
Radiation Pattern	Omni-Directional
Max. Input Power (W)	10



2JS50 Surface Mount Antenna

5.0GHz/WiFi/ISM

Key Features High Performance Ground Plane Dependent Ceramic Material Compact size Easy to Integrate



General specification

Mounting type	Surface mount Ceramic
Dimensions (mm)	13 x 13 x 4
Operating temperature	-40 °C to +85 °C

Antenna and electrical specifications

5.0GHz/WiFi/ISM (Connection 1)

Standards	WiFi/ISM
Frequency (MHz)	4920-5925
VSWR	~2.5:1
Efficiency (%)	~65.9
Peak Gain (dBi)	~5.1
Impedance (Ohm)	50
Polarisation	Linear
Radiation Pattern	Hemispheric

2JE07h Monopole Antenna

2.4-5.0GHz/WiFi/LPWA/BT/ISM

Key Features Ground Plane Dependent Ceramic Material Compact size Easy to Integrate



General specification

Mounting type	Surface mount Ceramic
Dimensions (mm)	5.3 x 2 x 1.3
Operating temperature	-40 °C to +85 °C

Antenna and electrical specifications

2.4-5.0GHz/WiFi/LPWA/BT/ISM (Connection 1)

Standards	WiFi/Sigfox/LoRa/LPWA/Bluetooth/ BLE/ZigBee/RFID/MPMA/ISM
Frequency (MHz)	2410-2490, 4920-5925
VSWR	~1.4:1, ~1.5:1
Efficiency (%)	~75.1, ~52.0
Peak Gain (dBi)	~2.3, ~1.9
Impedance (Ohm)	50
Polarisation	Linear
Radiation Pattern	Omni-Directional
Max. Input Power (W)	10

2JL40 Loop Antenna

2.4-5.0GHz/WiFi/LPWA/BT/ISM

Key Features Ground Plane Dependent Ceramic Material Compact size Easy to Integrate



General specification

Mounting type	Surface mount Ceramic
Dimensions (mm)	3.2 x 1.6 x 0.5
Operating temperature	-40 °C to +85 °C

Antenna and electrical specifications

2.4-5.0GHz/WiFi/LPWA/BT/ISM (Connection 1)

Standards	WiFi/Sigfox/LoRa/LPWA/Bluetooth/ BLE/ZigBee/RFID/MPMA/ISM
Frequency (MHz)	2410-2490, 4920-5925
VSWR	~1.6:1, ~2.0:1
Efficiency (%)	~67.1, ~56.2
Peak Gain (dBi)	~6.0, ~1.1
Impedance (Ohm)	50
Polarisation	Linear
Radiation Pattern	Omni-Directional
Max. Input Power (W)	10



2JE15b Monopole Antenna

433MHz/LPWA/RFID/ZigBee/ISM

Key Features ✓ Ground Plane Dependent ✓ Ceramic Material ✓ Compact size ✓ Easy to Integrate

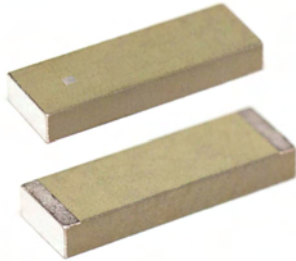

General specification

Mounting type	Surface mount Ceramic
Dimensions (mm)	12 × 4 × 1.6
Operating temperature	-40 °C to +85 °C

Antenna and electrical specifications

433MHz/LPWA/RFID/ZigBee/ISM (Connection 1)

Standards	Sigfox/LoRa/RFID/LPWA/ISM/UHF
Frequency (MHz)	433-435
VSWR	~1.5:1
Peak Gain (dBi)	~-10.3
Impedance (Ohm)	50
Polarisation	Linear
Radiation Pattern	Omni-Directional
Max. Input Power (W)	10

2JL01 Loop Antenna

433MHz/LPWA/RFID/ZigBee/ISM

Key Features ✓ Ground Plane Dependent ✓ Ceramic Material ✓ Compact size ✓ Easy to Integrate

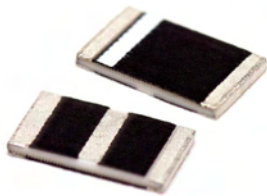

General specification

Mounting type	Surface mount Ceramic
Dimensions (mm)	5 × 3 × 0.5
Operating temperature	-40 °C to +85 °C

Antenna and electrical specifications

433MHz/LPWA/RFID/ZigBee/ISM (Connection 1)

Standards	Sigfox/LoRa/RFID/LPWA/ISM/UHF
Frequency (MHz)	433-435
VSWR	~1.5:1
Peak Gain (dBi)	~-4.7
Impedance (Ohm)	50
Polarisation	Linear
Radiation Pattern	Omni-Directional
Max. Input Power (W)	25

2JE05d Monopole Antenna

868MHz/Sigfox/LoRa/LPWA/RFID/ZigBee/ISM

Key Features ✓ Ground Plane Dependent ✓ Ceramic Material ✓ Compact size ✓ Easy to Integrate

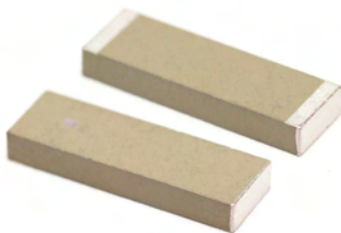

General specification

Mounting type	Surface mount Ceramic
Dimensions (mm)	12 × 4 × 1.6
Operating temperature	-40 °C to +85 °C

Antenna and electrical specifications

868MHz/Sigfox/LoRa/LPWA/RFID/ZigBee/ISM (Connection 1)

Standards	Sigfox/LoRa/ZigBee/RFID/LPWA/ISM/UHF
Frequency (MHz)	863-870
VSWR	~1:1
Efficiency (%)	~38
Peak Gain (dBi)	~-0.5
Impedance (Ohm)	50
Polarisation	Linear
Radiation Pattern	Omni-Directional
Max. Input Power (W)	10



2JL10 Loop Antenna

868MHz/Sigfox/LoRa/LPWA/RFID/ZigBee/ISM

Key Features ✓ Ground Plane Dependent ✓ Ceramic Material ✓ Compact size ✓ Easy to Integrate

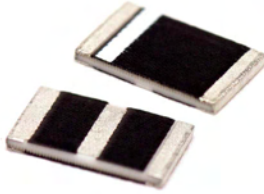

General specification

Mounting type	Surface mount Ceramic
Dimensions (mm)	5 × 3 × 0,5
Operating temperature	-40 °C to +85 °C

Antenna and electrical specifications

868MHz/Sigfox/LoRa/LPWA/RFID/ZigBee/ISM (Connection 1)

Standards	Sigfox/LoRa/ZigBee/RFID/LPWA/ISM/UHF
Frequency (MHz)	863-870
VSWR	~1.6:1
Efficiency (%)	~43.7
Peak Gain (dBi)	~1.0
Impedance (Ohm)	50
Polarisation	Linear
Radiation Pattern	Omni-Directional
Max. Input Power (W)	25

2JE05e Monopole Antenna

915MHz/Sigfox/LoRa/LPWA/RFID/ZigBee/ISM

Key Features ✓ Ground Plane Dependent ✓ Ceramic Material ✓ Compact size ✓ Easy to Integrate

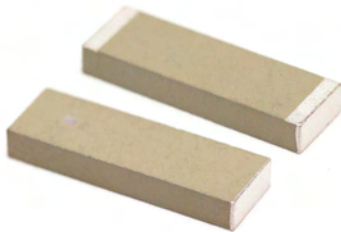

General specification

Mounting type	Surface mount Ceramic
Dimensions (mm)	12 × 4 × 1.6
Operating temperature	-40 °C to +85 °C

Antenna and electrical specifications

915MHz/Sigfox/LoRa/LPWA/RFID/ZigBee/ISM (Connection 1)

Standards	Sigfox/LoRa/ZigBee/RFID/LPWA/ISM/UHF
Frequency (MHz)	902-928
VSWR	~2.0:1
Efficiency (%)	~40.5
Peak Gain (dBi)	~1.0
Impedance (Ohm)	50
Polarisation	Linear
Radiation Pattern	Omni-Directional
Max. Input Power (W)	10

2JL20 Loop Antenna

915MHz/Sigfox/LoRa/LPWA/RFID/ZigBee/ISM

Key Features ✓ Ground Plane Dependent ✓ Ceramic Material ✓ Compact size ✓ Easy to Integrate



General specification

Mounting type	Surface mount Ceramic
Dimensions (mm)	10 × 3.2 × 0.5
Operating temperature	-40 °C to +85 °C

Antenna and electrical specifications

915MHz/Sigfox/LoRa/LPWA/RFID/ZigBee/ISM (Connection 1)

Standards	Sigfox/LoRa/ZigBee/RFID/LPWA/ISM/UHF
Frequency (MHz)	902-928
VSWR	~3.1:1
Efficiency (%)	~58.3
Peak Gain (dBi)	~0.2
Impedance (Ohm)	50
Polarisation	Linear
Radiation Pattern	Omni-Directional
Max. Input Power (W)	25



2JE21 5G Brick Antenna

5G NR/4G LTE/FirstNet/CBRS/LPWA/3G/2G

Key Features High Performance Ground Plane Dependent Fiberglass Material Compact size Embedded Antenna Easy to Integrate

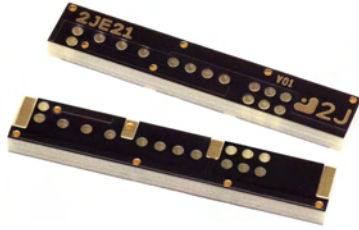

General specification

Mounting type	Surface mount Fiberglass
Dimensions (mm)	40 × 7 × 3
Operating temperature	-40 °C to +85 °C

Antenna and electrical specifications

5G NR/4G LTE/FirstNet/CBRS/LPWA/3G/2G

Standards	5G NR/4G LTE/FirstNet/CBRS/LPWA/ CAT-X/CAT-Mx/CAT-NBx/NB-IoT/3G/2G
Frequency (MHz)	617-960, 1427-2690, 3300-5000, 5150-5925
Bands	see 5G Bands list on page 17
VSWR	~3.0:1, ~2.3:1, ~2.8:1, ~2.4:1
Efficiency (%)	~53.0, ~60.8, ~45.3, ~43.1
Peak Gain (dBi)	~1.4, ~3.3, ~2.9, ~1.8
Impedance (Ohm)	50
Polarisation	Linear
Radiation Pattern	Omni-Directional
Max. Input Power (W)	25

2JE18 Brick Antenna

4G LTE/FirstNet/LPWA/NB-IoT/3G/2G

Key Features High Performance Ground Plane Dependent Fiberglass Material Compact size Embedded Antenna Easy to Integrate



General specification

Mounting type	Surface mount Fiberglass
Dimensions (mm)	40 × 7 × 3
Operating temperature	-40 °C to +85 °C

Antenna and electrical specifications

4G LTE/FirstNet/LPWA/NB-IoT/3G/2G

Standards	4G LTE/FirstNet/LPWA/ CAT-X/CAT-Mx/CAT-NBx/NB-IoT/3G/2G
Frequency (MHz)	698-960, 1710-2170, 2500-2700
VSWR	~2.8:1, ~1.5:1, ~1.7:1
Efficiency (%)	~54.8, ~67.5, ~70.1
Peak Gain (dBi)	~1.2, ~4.1, ~4.2
Impedance (Ohm)	50
Polarisation	Linear
Radiation Pattern	Omni-Directional
Max. Input Power (W)	25

2JE03 Brick Antenna

3G/2G/CELLULAR

Key Features High Performance Ground Plane Dependent Fiberglass Material Compact size Embedded Antenna Easy to Integrate

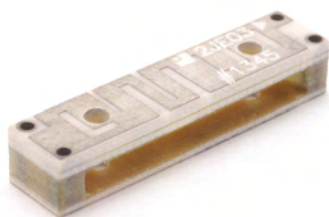

General specification

Mounting type	Surface mount Fiberglass
Dimensions (mm)	24 × 5.5 × 4.4
Operating temperature	-40 °C to +85 °C

Antenna and electrical specifications

3G/2G/CELLULAR

Standards	3G/Cellular/HSPA/UMTS/WCDMA/ EDGE/EGPRS/GRPS/GSM/CDMA/2G
Frequency (MHz)	824-960, 1710-2170
VSWR	~3:1, ~3:1
Efficiency (%)	~55, ~45
Peak Gain (dBi)	~1, ~3
Impedance (Ohm)	50
Polarisation	Linear
Radiation Pattern	Omni-Directional
Max. Input Power (W)	25



2JE04 Brick Antenna 3G/2G/CELLULAR

Key Features High Performance Ground Plane Dependent Fiberglass Material Compact size Embedded Antenna Easy to Integrate

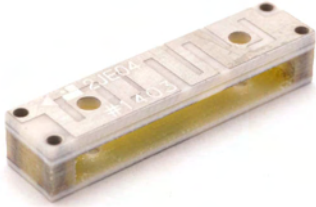

General specification

Mounting type	Surface mount Fiberglass
Dimensions (mm)	25 × 5.5 × 4.4
Operating temperature	-40 °C to +85 °C

Antenna and electrical specifications 3G/2G/CELLULAR

Standards	3G/Cellular/HSPA/UMTS/WCDA/ EDGE/EGPRS/GRPS/GSM/CDMA/2G
Frequency (MHz)	824-960, 1710-2170
VSWR	~3:1, ~3:1
Efficiency (%)	~55, ~45
Peak Gain (dBi)	~1, ~3
Impedance (Ohm)	50
Polarisation	Linear
Radiation Pattern	Omni-Directional
Max. Input Power (W)	25

2JE17 Brick Antenna 3G/2G/CELLULAR

Key Features High Performance Ground Plane Dependent Fiberglass Material Compact size Embedded Antenna Easy to Integrate

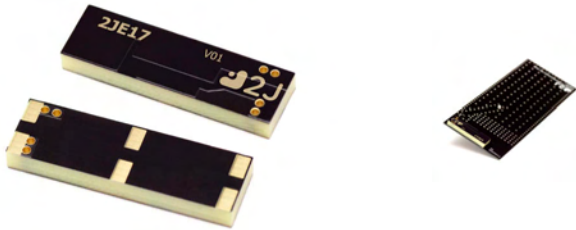

General specification

Mounting type	Surface mount Fiberglass
Dimensions (mm)	26 × 7.6 × 3
Operating temperature	-40 °C to +85 °C

Antenna and electrical specifications 3G/2G/CELLULAR

Standards	3G/Cellular/HSPA/UMTS/WCDA/ EDGE/EGPRS/GRPS/GSM/CDMA/2G
Frequency (MHz)	824-960, 1710-2170
VSWR	~2.0:1, ~1.8:1
Efficiency (%)	~67.5, ~70.8
Peak Gain (dBi)	~2.2, ~2.2
Impedance (Ohm)	50
Polarisation	Linear
Radiation Pattern	Omni-Directional
Max. Input Power (W)	25

2JE06a Brick Antenna 169MHz/ERMES/VHF

Key Features High Performance Ground Plane Dependent Fiberglass Material Compact size Embedded Antenna Easy to Integrate

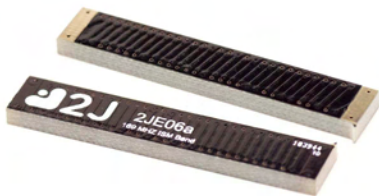

General specification

Mounting type	Surface mount Fiberglass
Dimensions (mm)	40 × 7 × 2.4
Operating temperature	-40 °C to +85 °C

Antenna and electrical specifications 169MHz/ERMES/VHF

Standards	169MHz/ERMES/VHF
Frequency (MHz)	169
VSWR	~1.2:1
Impedance (Ohm)	50
Peak Gain (dBi)	~6.0
Polarisation	Linear
Radiation Pattern	Omni-Directional
Max. Input Power (W)	10

2JCP1840101a Passive Patch GNSS

GPS/QZSS/Galileo/L1

Key Features  High Performance  Ground Plane Dependent  Ceramic Material

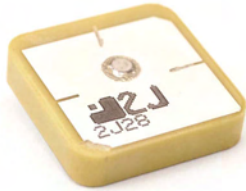

General specification

Mounting type	Thru-Hole mount Ceramic
Dimensions (mm)	18 × 18 × 4
Operating temperature	-40 °C to +85 °C

Antenna and electrical specifications

GPS/QZSS/Galileo/L1

Standards	GPS(L1)/QZSS(L1)/Galileo(E1)
Frequency (MHz)	1575.42
VSWR	~1.0:1
Efficiency (%)	~65
Peak Gain (dBi)	~3.6
Impedance (Ohm)	50
Polarisation	RHCP
Radiation Pattern	Hemispherical

2JCP2540101a Passive Patch GNSS

GPS/QZSS/Galileo/L1

Key Features  High Performance  Ground Plane Dependent  Ceramic Material

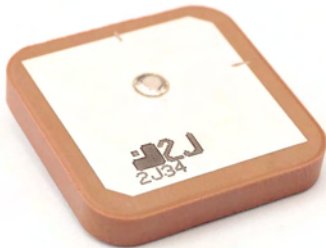

General specification

Mounting type	Thru-Hole mount Ceramic
Dimensions (mm)	25 × 25 × 4
Operating temperature	-40 °C to +85 °C

Antenna and electrical specifications

GPS/QZSS/Galileo/L1

Standards	GPS(L1)/QZSS(L1)/Galileo(E1)
Frequency (MHz)	1575.42
VSWR	~1.1:1
Efficiency (%)	~69
Peak Gain (dBi)	~3.9
Impedance (Ohm)	50
Polarisation	RHCP
Radiation Pattern	Hemispherical

2JCP1340101Ga Passive Patch GNSS

GPS/GLONASS/QZSS/Galileo/L1

Key Features  High Performance  Ground Plane Dependent  Ceramic Material



General specification

Mounting type	Thru-Hole mount Ceramic
Dimensions (mm)	13 × 13 × 4
Operating temperature	-40 °C to +85 °C

Antenna and electrical specifications

GPS/GLONASS/QZSS/Galileo/L1

Standards	GPS(L1)/GLONASS(L10F)/QZSS(L1)/Galileo(E1)
Frequency (MHz)	1575.42, 1598-1606
VSWR	~2.0:1, ~1.6:1
Efficiency (%)	~58.5, ~54.6
Peak Gain (dBi)	~3.5, ~3.1
Impedance (Ohm)	50
Polarisation	RHCP
Radiation Pattern	Hemispherical



2JCP1840101Ga Passive Patch GNSS

GPS/GLONASS/QZSS/Galileo/L1

Key Features High Performance Ground Plane Dependent Ceramic Material

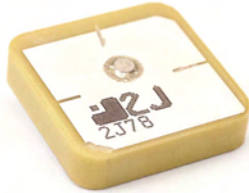

General specification

Mounting type	Thru-Hole mount Ceramic
Dimensions (mm)	18 × 18 × 4
Operating temperature	-40 °C to +85 °C

Antenna and electrical specifications

GPS/GLONASS/QZSS/Galileo/L1

Standards	GPS(L1)/GLONASS(L10F)/QZSS(L1)/Galileo(E1)
Frequency (MHz)	1575.42, 1598-1606
VSWR	~1.1:1, ~1.3:1
Efficiency (%)	~73.9, ~73.7
Peak Gain (dBi)	~4.1, ~4.2
Impedance (Ohm)	50
Polarisation	RHCP
Radiation Pattern	Hemispherical

2JCP2540101Ga Passive Patch GNSS

GPS/GLONASS/QZSS/Galileo/L1

Key Features High Performance Ground Plane Dependent Ceramic Material



General specification

Mounting type	Thru-Hole mount Ceramic
Dimensions (mm)	25 × 25 × 4
Operating temperature	-40 °C to +85 °C

Antenna and electrical specifications

GPS/GLONASS/QZSS/Galileo/L1

Standards	GPS(L1)/GLONASS(L10F)/QZSS(L1)/Galileo(E1)
Frequency (MHz)	1575.42, 1598-1606
VSWR	~1.1:1, ~1.4:1
Efficiency (%)	~65, ~68
Peak Gain (dBi)	~3.6, ~3.9
Impedance (Ohm)	50
Polarisation	RHCP
Radiation Pattern	Hemispherical

2JCP1840101Ca Passive Patch GNSS

GPS/GLONASS/BEIDOU/QZSS/Galileo/L1

Key Features High Performance Ground Plane Dependent Ceramic Material



General specification

Mounting type	Thru-Hole mount Ceramic
Dimensions (mm)	18 × 18 × 4
Operating temperature	-40 °C to +85 °C

Antenna and electrical specifications

GPS/GLONASS/BEIDOU/QZSS/Galileo/L1

Standards	GPS(L1)/GLONASS(L10F)/BeiDou(B1)/QZSS(L1)/Galileo(E1)
Frequency (MHz)	1561.098, 1575.42, 1598-1606
VSWR	~2.7:1, ~2.6:1, ~1.4:1
Efficiency (%)	~65.6, ~61.4, ~68.7
Peak Gain (dBi)	~5.2, ~5.4, ~5.4
Impedance (Ohm)	50
Polarisation	RHCP
Radiation Pattern	Hemispherical

2JCP2540101Ca Passive Patch GNSS

GPS/GLONASS/BEIDOU/QZSS/Galileo/L1

Key Features  High Performance  Ground Plane Dependent  Ceramic Material



General specification

Mounting type	Thru-Hole mount Ceramic
Dimensions (mm)	25 × 25 × 4
Operating temperature	-40 °C to +85 °C

Antenna and electrical specifications

GPS/GLONASS/BEIDOU/QZSS/Galileo/L1

Standards	GPS(L1)/GLONASS(L10F)/BeiDou(B1)/QZSS(L1)/Galileo(E1)
Frequency (MHz)	1561.098, 1575.42, 1598-1606
VSWR	~1.6:1, ~2.0:1, ~1.4:1
Efficiency (%)	~72.2, ~79.7, ~81.6
Peak Gain (dBi)	~4.2, ~4.5, ~5.0
Impedance (Ohm)	50
Polarisation	RHCP
Radiation Pattern	Hemispherical

2JCP3640101Ca Passive Patch GNSS

GPS/GLONASS/BEIDOU/QZSS/Galileo/L1

Key Features  High Performance  Ground Plane Dependent  Ceramic Material



General specification

Mounting type	Thru-Hole mount Ceramic
Dimensions (mm)	36 × 36 × 4
Operating temperature	-40 °C to +85 °C

Antenna and electrical specifications

GPS/GLONASS/BEIDOU/QZSS/Galileo/L1

Standards	GPS(L1)/GLONASS(L10F)/BeiDou(B1)/QZSS(L1)/Galileo(E1)
Frequency (MHz)	1561.098, 1575.42, 1598-1606
VSWR	~1.6:1, ~1.4:1, ~1.3:1
Efficiency (%)	~73, ~69, ~71
Peak Gain (dBi)	~4.0, ~3.8, ~4.1
Impedance (Ohm)	50
Polarisation	RHCP
Radiation Pattern	Hemispherical

2JCP2543301a Passive Patch GNSS

GPS/QZSS/Galileo/L1/IRIDIUM

Key Features  High Performance  Ground Plane Dependent  Ceramic Material  Single Feed Technology



General specification

Mounting type	Thru-Hole mount Ceramic
Dimensions (mm)	25 × 25 × 4
Operating temperature	-40 °C to +85 °C

Antenna and electrical specifications

GPS/QZSS/Galileo/L1/IRIDIUM

Standards	GPS(L1)/QZSS(L1)/Galileo(E1), IRIDIUM
Frequency (MHz)	1575.42, 1616-1627
VSWR	~1.1:1, ~1.3:1
Efficiency (%)	~93.8, ~92.9
Peak Gain (dBi)	~5.1, ~5.7
Impedance (Ohm)	50
Polarisation	RHCP
Radiation Pattern	Hemispherical



2JCP1841501a Passive Patch GNSS 868MHz/Sigfox/LoRa/LPWA/RFID/ZigBee/ISM

Key Features High Performance Ground Plane Dependent Ceramic Material

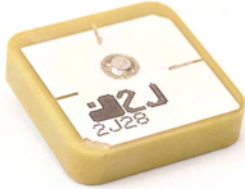

General specification

Mounting type	Thru-Hole mount Ceramic
Dimensions (mm)	18 x 18 x 4
Operating temperature	-40 °C to +85 °C

Antenna and electrical specifications

868MHz/Sigfox/LoRa/LPWA/RFID/ZigBee/ISM (Connection 1)

Standards	Sigfox/LoRa/ZigBee/RFID/LPWA/ISM/UHF
Frequency (MHz)	863-870
VSWR	~1.9:1
Peak Gain (dBi)	~-6.4
Impedance (Ohm)	50
Polarisation	RHCP
Radiation Pattern	Hemispherical
Axial Ratio (dB)	3 max.

2JCP2542601a IRIDIUM

Key Features High Performance Ground Plane Dependent Ceramic Material

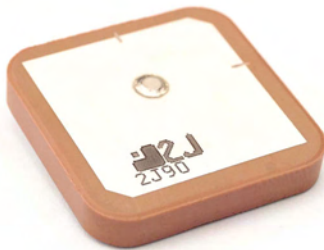

General specification

Mounting type	Thru-Hole mount Ceramic
Dimensions (mm)	25 x 25 x 4
Operating temperature	-40 °C to +85 °C

Antenna and electrical specifications

IRIDIUM (Connection 4)

Standards	IRIDIUM
Frequency (MHz)	1616-1627
VSWR	~1.1:1
Efficiency (%)	~82.3
Peak Gain (dBi)	~5.1
Impedance (Ohm)	50
Polarisation	RHCP
Radiation Pattern	Hemispherical
Axial Ratio (dB)	3 max.

2JCP3642601a IRIDIUM

Key Features High Performance Ground Plane Dependent Ceramic Material



General specification

Mounting type	Thru-Hole mount Ceramic
Dimensions (mm)	36 x 36 x 4
Operating temperature	-40 °C to +85 °C

Antenna and electrical specifications

IRIDIUM (Connection 4)

Standards	IRIDIUM
Frequency (MHz)	1616-1627
VSWR	~1.2:1
Efficiency (%)	~76
Peak Gain (dBi)	~4.5
Impedance (Ohm)	50
Polarisation	RHCP
Radiation Pattern	Hemispherical
Axial Ratio (dB)	3 max.

2JM001F Active Patch GNSS GPS/QZSS/Galileo/L1

Key Features  25 dB Gain  Ground Plane Independent  High Voltage  Customizable Cable and Connector  Pre-Filter

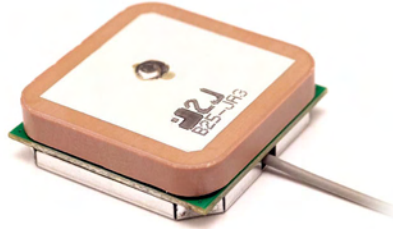

General specification

Mounting type	Snap-in mount Module
Dimensions (mm)	25 × 25 × 7.7
Operating temperature	-40 °C to +85 °C

Antenna and electrical specifications GPS/QZSS/Galileo/L1

Standards	GPS(L1)/QZSS(L1)/Galileo(E1)
Frequency (MHz)	1575.42
Impedance (Ohm)	50
Passive Gain (dBi)	~3.6
Radiation Pattern	Hemispherical
Active Gain (dB)	25 @ 5 V
Voltage (V)	3.0 - 5.0
Current Consumption (mA)	20 @ 5.0 V
Power Consumption (mW)	100 @ 5.0 V
Saw Filter Type	Pre-Filter
Out of Band Rejection (dB)	43
ESD Protection (kV)	2

2JM0301F Active Patch GNSS GPS/QZSS/Galileo/L1

Key Features  14 dB Gain  Ground Plane Independent  Low Noise Figure  Low Power Consumption  Customizable Cable and Connector  Pre-Filter

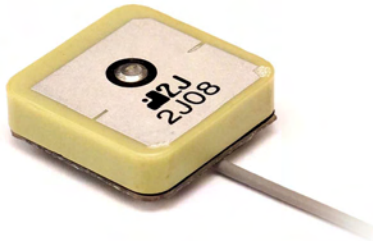





General specification

Mounting type	Snap-in mount Module
Dimensions (mm)	18 × 18 × 6.8
Operating temperature	-40 °C to +85 °C

Antenna and electrical specifications GPS/QZSS/Galileo/L1

Standards	GPS(L1)/QZSS(L1)/Galileo(E1)
Frequency (MHz)	1575.42
Impedance (Ohm)	50
Passive Gain (dBi)	~3.6
Radiation Pattern	Hemispherical
Active Gain (dB)	14 @ 2.7 V
Voltage (V)	1.5 - 3.6
Current Consumption (mA)	4 @ 2.7 V
Power Consumption (mW)	10.8 @ 2.7 V
Saw Filter Type	Pre-Filter
Out of Band Rejection (dB)	43
ESD Protection (kV)	6

2JM0401F Active Patch GNSS GPS/QZSS/Galileo/L1

Key Features  28 dB Gain  Ground Plane Independent  Low Noise Figure  Low Power Consumption  Customizable Cable and Connector  Pre-Filter

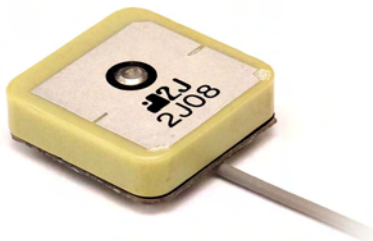

General specification

Mounting type	Snap-in mount Module
Dimensions (mm)	18 × 18 × 6.5
Operating temperature	-40 °C to +85 °C

Antenna and electrical specifications GPS/QZSS/Galileo/L1

Standards	GPS(L1)/QZSS(L1)/Galileo(E1)
Frequency (MHz)	1575.42
Impedance (Ohm)	50
Passive Gain (dBi)	~3.6
Radiation Pattern	Hemispherical
Active Gain (dB)	28 @ 2.7 V
Voltage (V)	1.5 - 3.6
Current Consumption (mA)	9 @ 2.7 V
Power Consumption (mW)	24.3 Typ
Saw Filter Type	Pre-Filter
Out of Band Rejection (dB)	43
ESD Protection (kV)	6



2JM0501F Active Patch GNSS

GPS/QZSS/Galileo/L1

- Key Features**
- ✔ 28 dB Gain
 - ✔ Ground Plane Independent
 - ✔ Low Noise Figure
 - ✔ Low Power Consumption
 - ✔ Customizable Cable and Connector
 - ✔ Mid-Filter

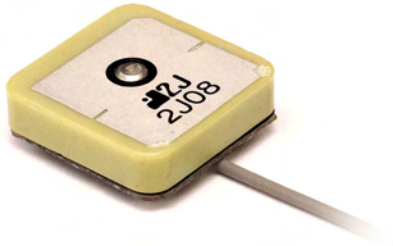

General specification

Mounting type	Snap-in mount Module
Dimensions (mm)	18 × 18 × 6.5
Operating temperature	-40 °C to +85 °C

Antenna and electrical specifications

GPS/QZSS/Galileo/L1

Standards	GPS(L1)/QZSS(L1)/Galileo(E1)
Frequency (MHz)	1575.42
Impedance (Ohm)	50
Passive Gain (dBi)	~3.6
Radiation Pattern	Hemispherical
Active Gain (dB)	28 @ 2.7 V
Voltage (V)	1.5 - 3.6
Current Consumption (mA)	9 @ 2.7 V
Power Consumption (mW)	24.3 Typ
Saw Filter Type	Mid-Filter
Out of Band Rejection (dB)	43
ESD Protection (kV)	6

2JM0601F Active Patch GNSS

GPS/QZSS/Galileo/L1

- Key Features**
- ✔ 14 dB Gain
 - ✔ Ground Plane Independent
 - ✔ Low Noise Figure
 - ✔ Low Power Consumption
 - ✔ Customizable Cable and Connector
 - ✔ Pre-Filter



General specification

Mounting type	Snap-in mount Module
Dimensions (mm)	25 × 25 × 7.6
Operating temperature	-40 °C to +85 °C

Antenna and electrical specifications

GPS/QZSS/Galileo/L1

Standards	GPS(L1)/QZSS(L1)/Galileo(E1)
Frequency (MHz)	1575.42
Impedance (Ohm)	50
Passive Gain (dBi)	~3.6
Radiation Pattern	Hemispherical
Active Gain (dB)	14 @ 2.7 V
Voltage (V)	1.5 - 3.6
Current Consumption (mA)	4 @ 2.7 V
Power Consumption (mW)	10.8 Typ
Saw Filter Type	Pre-Filter
Out of Band Rejection (dB)	43
ESD Protection (kV)	6

2JM0701F Active Patch GNSS

GPS/QZSS/Galileo/L1

- Key Features**
- ✔ 28 dB Gain
 - ✔ Ground Plane Independent
 - ✔ Low Noise Figure
 - ✔ Low Power Consumption
 - ✔ Customizable Cable and Connector
 - ✔ Pre-Filter



General specification

Mounting type	Snap-in mount Module
Dimensions (mm)	25 × 25 × 7.6
Operating temperature	-40 °C to +85 °C







Antenna and electrical specifications

GPS/QZSS/Galileo/L1

Standards	GPS(L1)/QZSS(L1)/Galileo(E1)
Frequency (MHz)	1575.42
Impedance (Ohm)	50
Passive Gain (dBi)	~3.6
Radiation Pattern	Hemispherical
Active Gain (dB)	28 @ 2.7 V
Voltage (V)	1.5 - 3.6
Current Consumption (mA)	9 @ 2.7 V
Power Consumption (mW)	24.3 Typ
Saw Filter Type	Pre-Filter
Out of Band Rejection (dB)	43
ESD Protection (kV)	6

2JM0801F Active Patch GNSS

GPS/QZSS/Galileo/L1

- Key Features**  28 dB Gain  Ground Plane Independent  Low Noise Figure  Low Power Consumption
 Customizable Cable and Connector  Mid-Filter



General specification

Mounting type	Snap-in mount Module
Dimensions (mm)	25 × 25 × 7.6
Operating temperature	-40 °C to +85 °C



Antenna and electrical specifications

GPS/QZSS/Galileo/L1

Standards	GPS(L1)/QZSS(L1)/Galileo(E1)
Frequency (MHz)	1575.42
Impedance (Ohm)	50
Passive Gain (dBi)	~3.6
Radiation Pattern	Hemispherical
Active Gain (dB)	28 @ 2.7 V
Voltage (V)	1.5 - 3.6
Current Consumption (mA)	9 @ 2.7 V
Power Consumption (mW)	24.3 Typ
Saw Filter Type	Mid-Filter
Out of Band Rejection (dB)	43
ESD Protection (kV)	2

2JM0301GF Active Patch GNSS

GPS/GLONASS/QZSS/Galileo/L1

- Key Features**  14 dB Gain  Ground Plane Independent  Low Noise Figure  Low Power Consumption
 Customizable Cable and Connector  Pre-Filter

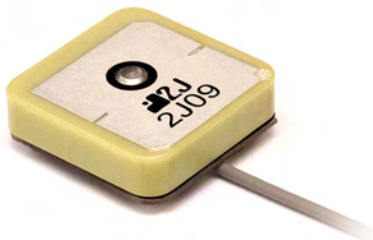

General specification

Mounting type	Snap-in mount Module
Dimensions (mm)	18 × 18 × 6.8
Operating temperature	-40 °C to +85 °C

Antenna and electrical specifications

GPS/GLONASS/QZSS/Galileo/L1

Standards	GPS(L1)/GLONASS(L10F)/QZSS(L1)/Galileo(E1)
Frequency (MHz)	1575.42, 1598-1606
Impedance (Ohm)	50
Passive Gain (dBi)	~3.6
Radiation Pattern	Hemispherical
Active Gain (dB)	14 @ 2.7 V
Voltage (V)	1.5 - 3.6
Current Consumption (mA)	4 @ 2.7 V
Power Consumption (mW)	10.8 Typ
Saw Filter Type	Pre-Filter
Out of Band Rejection (dB)	43
ESD Protection (kV)	6

2JM0401GF Active Patch GNSS

GPS/GLONASS/QZSS/Galileo/L1

- Key Features**  28 dB Gain  Ground Plane Independent  Low Noise Figure  Low Power Consumption
 Customizable Cable and Connector  Pre-Filter

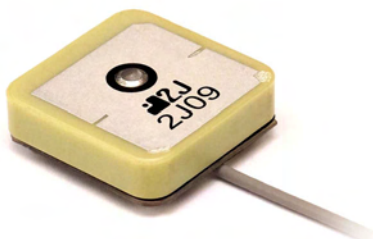

General specification

Mounting type	Snap-in mount Module
Dimensions (mm)	18 × 18 × 6.8
Operating temperature	-40 °C to +85 °C

Antenna and electrical specifications

GPS/GLONASS/QZSS/Galileo/L1

Standards	GPS(L1)/GLONASS(L10F)/QZSS(L1)/Galileo(E1)
Frequency (MHz)	1575.42, 1598-1606
Impedance (Ohm)	50
Passive Gain (dBi)	~3.6
Radiation Pattern	Hemispherical
Active Gain (dB)	28 @ 2.7 V
Voltage (V)	1.5 - 3.6
Current Consumption (mA)	9 @ 2.7 V
Power Consumption (mW)	24.3 Typ
Saw Filter Type	Pre-Filter
Out of Band Rejection (dB)	43
ESD Protection (kV)	6



2JM0501GF Active Patch GNSS GPS/GLONASS/QZSS/Galileo/L1

- Key Features**
- ✔ 28 dB Gain
 - ✔ Ground Plane Independent
 - ✔ Low Noise Figure
 - ✔ Low Power Consumption
 - ✔ Customizable Cable and Connector
 - ✔ Mid-Filter

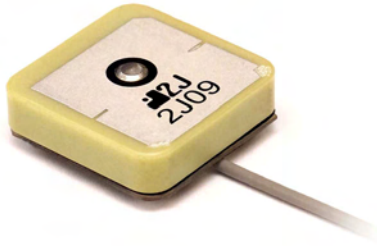

General specification

Mounting type	Snap-in mount Module
Dimensions (mm)	18 × 18 × 6.8
Operating temperature	-40 °C to +85 °C

Antenna and electrical specifications GPS/GLONASS/QZSS/Galileo/L1

Standards	GPS(L1)/GLONASS(L10F)/QZSS(L1)/Galileo(E1)
Frequency (MHz)	1575.42, 1598-1606
Impedance (Ohm)	50
Passive Gain (dBi)	~3.6
Radiation Pattern	Hemispherical
Active Gain (dB)	28 @ 2.7 V
Voltage (V)	1.5 - 3.6
Current Consumption (mA)	9 @ 2.7 V
Power Consumption (mW)	24.3 Typ
Saw Filter Type	Mid-Filter
Out of Band Rejection (dB)	43
ESD Protection (kV)	6

2JM0601GF Active Patch GNSS GPS/GLONASS/QZSS/Galileo/L1

- Key Features**
- ✔ 14 dB Gain
 - ✔ Ground Plane Independent
 - ✔ Low Noise Figure
 - ✔ Low Power Consumption
 - ✔ Customizable Cable and Connector
 - ✔ Pre-Filter



General specification

Mounting type	Snap-in mount Module
Dimensions (mm)	25 × 25 × 7.6
Operating temperature	-40 °C to +85 °C

Antenna and electrical specifications GPS/GLONASS/QZSS/Galileo/L1

Standards	GPS(L1)/GLONASS(L10F)/QZSS(L1)/Galileo(E1)
Frequency (MHz)	1575.42, 1598-1606
Impedance (Ohm)	50
Passive Gain (dBi)	~3.6
Radiation Pattern	Hemispherical
Active Gain (dB)	14 @ 2.7 V
Voltage (V)	1.5 - 3.6
Current Consumption (mA)	4 @ 2.7 V
Power Consumption (mW)	10.8 Typ
Saw Filter Type	Pre-Filter
Out of Band Rejection (dB)	43
ESD Protection (kV)	6

2JM0701GF Active Patch GNSS GPS/GLONASS/QZSS/Galileo/L1

- Key Features**
- ✔ 28 dB Gain
 - ✔ Ground Plane Independent
 - ✔ Low Noise Figure
 - ✔ Low Power Consumption
 - ✔ Customizable Cable and Connector
 - ✔ Pre-Filter







General specification

Mounting type	Snap-in mount Module
Dimensions (mm)	25 × 25 × 7.6
Operating temperature	-40 °C to +85 °C

Antenna and electrical specifications GPS/GLONASS/QZSS/Galileo/L1

Standards	GPS(L1)/GLONASS(L10F)/QZSS(L1)/Galileo(E1)
Frequency (MHz)	1575.42, 1598-1606
Impedance (Ohm)	50
Passive Gain (dBi)	~3.6
Radiation Pattern	Hemispherical
Active Gain (dB)	28 @ 2.7 V
Voltage (V)	1.5 - 3.6
Current Consumption (mA)	9 @ 2.7 V
Power Consumption (mW)	24.3 Typ
Saw Filter Type	Pre-Filter
Out of Band Rejection (dB)	43
ESD Protection (kV)	6

2JM0801GF Active Patch GNSS GPS/GLONASS/QZSS/Galileo/L1

Key Features  28 dB Gain  Ground Plane Independent  Low Noise Figure  Low Power Consumption
 Customizable Cable and Connector  Mid-Filter



General specification

Mounting type	Snap-in mount Module
Dimensions (mm)	25 × 25 × 7.6
Operating temperature	-40 °C to +85 °C

Antenna and electrical specifications

GPS/GLONASS/QZSS/Galileo/L1

Standards	GPS(L1)/GLONASS(L10F)/QZSS(L1)/Galileo(E1)
Frequency (MHz)	1575.42, 1598-1606
Impedance (Ohm)	50
Passive Gain (dBi)	~3.6
Radiation Pattern	Hemispherical
Active Gain (dB)	28 @ 2.7 V
Voltage (V)	1.5 - 3.6
Current Consumption (mA)	9 @ 2.7 V
Power Consumption (mW)	24.3 Typ
Saw Filter Type	Mid-Filter
Out of Band Rejection (dB)	43
ESD Protection (kV)	2



2JP0433B Passive GNSS GPS/QZSS/Galileo/L1/IRIDIUM

Key Features High Performance Ground Plane Independent Single Feed Technology Customizable Cable and Connector

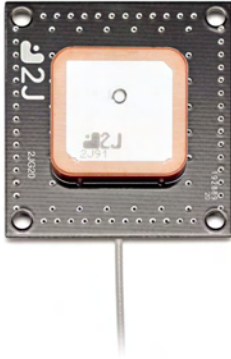

General specification

Mounting type	Screw mount Module
Dimensions (mm)	46 × 42 × 7.6
Operating temperature	-40 °C to +85 °C

Antenna and electrical specifications GPS/QZSS/Galileo/L1/IRIDIUM

Standards	GPS(L1)/QZSS(L1)/Galileo(E1), IRIDIUM
Frequency (MHz)	1575.42, 1616-1627
Impedance (Ohm)	50
Polarisation	RHCP
Radiation Pattern	Hemispherical
VSWR	~1.6:1, ~1.5:1
Peak Gain (dB)	~2.5, ~2.6
Efficiency (%)	~66.6, ~65.9

2JP0126B IRIDIUM

Key Features High Performance Ground Plane Independent Customizable Cable and Connector



General specification

Mounting type	Screw mount Module
Dimensions (mm)	70 × 70 × 7.6
Operating temperature	-40 °C to +85 °C

Antenna and electrical specifications IRIDIUM

Standards	IRIDIUM
Frequency (MHz)	1616-1627
VSWR	~1.1:1
Efficiency (%)	~84.2
Peak Gain (dBi)	~5.0
Impedance (Ohm)	50
Polarisation	RHCP
Radiation Pattern	Hemispherical
Axial Ratio (dB)	3 max.

2JP0126Bz IRIDIUM

Key Features High Performance Ground Plane Independent Customizable Cable and Connector



General specification

Mounting type	Screw mount Module
Dimensions (mm)	70 × 70 × 7.6
Operating temperature	-40 °C to +85 °C

Antenna and electrical specifications IRIDIUM

Standards	IRIDIUM
Frequency (MHz)	1616-1627
VSWR	~1.6:1
Efficiency (%)	~76.6
Peak Gain (dBi)	~4.8
Impedance (Ohm)	50
Polarisation	RHCP
Radiation Pattern	Hemispherical
Axial Ratio (dB)	3 max.

2JP0226B

IRIDIUM

Key Features

-  High Performance
-  Ground Plane Independent
-  Customizable Cable and Connector

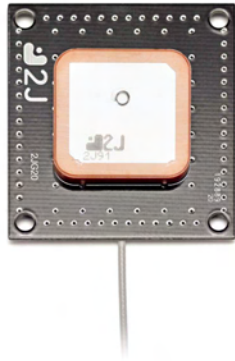

General specification

Mounting type	Screw mount Module
Dimensions (mm)	46 × 42 × 7,6
Operating temperature	-40 °C to +85 °C

Antenna and electrical specifications

IRIDIUM

Standards	IRIDIUM
Frequency (MHz)	1616-1627
VSWR	~1.4:1
Efficiency (%)	~70
Peak Gain (dBi)	~3.4
Impedance (Ohm)	50
Polarisation	RHCP
Radiation Pattern	Hemispherical
Axial Ratio (dB)	3 max.



2JF0302Pa

2x 2.4-5.0GHz/WiFi/LPWA/BT/ISM

- Key Features**
- ✔ High Performance
 - ✔ Ground Plane Independent
 - ✔ Flexible Self-Adhesive Embedded Antenna
 - ✔ Compact Size
 - ✔ Customizable Cable and Connector



General specification

Mounting type	Adhesive mount Flexible
Dimensions (mm)	22.4 × 20.6 × 0.2
Operating temperature	-40 °C to +85 °C

Antenna and electrical specifications

2.4-5.0GHz/WiFi/LPWA/BT/ISM (Connection 1)

Standards	WiFi/Sigfox/LoRa/LPWA/Bluetooth/ BLE/ZigBee/RFID/RFMA/ISM
Frequency (MHz)	2410-2490, 4920-5925
VSWR	~2.4:1, ~2.2:1
Efficiency (%)	~53, ~64
Peak Gain (dBi)	~3.2, ~5.0
Impedance (Ohm)	50
Polarisation	Linear
Radiation Pattern	Omni-Directional
Max. Input Power (W)	10

Antenna and electrical specifications

2.4-5.0GHz/WiFi/LPWA/BT/ISM (Connection 2)

Standards	WiFi/Sigfox/LoRa/LPWA/Bluetooth/ BLE/ZigBee/RFID/RFMA/ISM
Frequency (MHz)	2410-2490, 4920-5925
VSWR	~2.4:1, ~2.2:1
Efficiency (%)	~55, ~63
Peak Gain (dBi)	~3.0, ~4.9
Impedance (Ohm)	50
Polarisation	Linear
Radiation Pattern	Omni-Directional
Max. Input Power (W)	10



2JP0133BGF Active GNSS GPS/GLONASS/QZSS/Galileo/L1 & IRIDIUM

- Key Features**
- ✔ High Performance
 - ✔ Ground Plane Independent
 - ✔ Customizable Cable and Connector
 - ✔ Low Power Consumption
 - ✔ Low Noise Figure
 - ✔ Pre-Filter GNSS

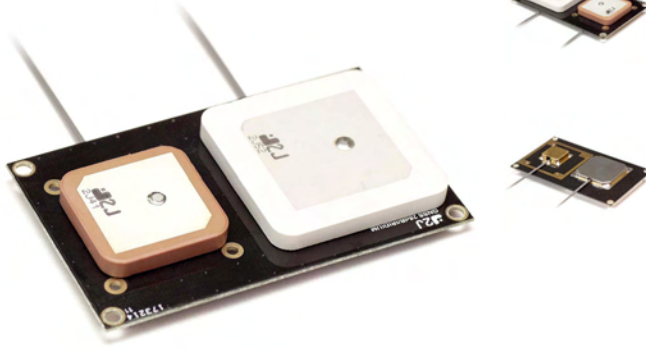

General specification

Mounting type	Screw mount Module
Dimensions (mm)	74 × 45 × 8.8
Operating temperature	-40 °C to +85 °C

Antenna and electrical specifications

GPS/GLONASS/QZSS/Galileo/L1

Standards	GPS(L1)/GLONASS(L1OF)/QZSS(L1)/Galileo(E1)
Frequency (MHz)	1575.42, 1598-1606
Impedance (Ohm)	50
Passive Gain (dBi)	~3.6
Radiation Pattern	Hemispherical
Active Gain (dB)	28 @ 2.7 V
Voltage (V)	1.5 - 3.6
Current Consumption (mA)	9 @ 2.7 V
Power Consumption (mW)	24.3 Typ
Saw Filter Type	Pre-Filter
Out of Band Rejection (dB)	43
ESD Protection (kV)	6

Antenna and electrical specifications

IRIDIUM

Standards	IRIDIUM
Frequency (MHz)	1616-1627
VSWR	~1.2:1
Efficiency (%)	~76
Peak Gain (dBi)	~4.5
Impedance (Ohm)	50
Polarisation	RHCP
Radiation Pattern	Hemispherical
Axial Ratio (dB)	3 max.

Development Kits & Boards



2JDK0101a-C104N

GPS/QZSS/Galileo/L1

Key Features ✓ Development Kit for GNSS ✓ Set of 6 patches to try on devices ✓ High Gain ✓ Patches 18 × 18 × 4 mm

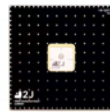
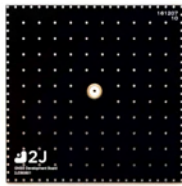

General specification

Mounting type	Thru-Hole mount Ceramic
Dimensions (mm)	18 × 18 × 4 (Patches) 70.4 × 70.4 × 13.5 (Board)
Operating temperature	-40 °C to +85 °C

Antenna and electrical specifications GPS/QZSS/Galileo/L1

Standards	GPS(L1)/QZSS(L1)/Galileo(E1)
Frequency (MHz)	1575.42 - Ceramic patch 2JCP1840101a (2J28) 1580.42 - Ceramic patch 2JCP1840102a (2J29) 1585.42 - Ceramic patch 2JCP1840103a (2J30) 1590.42 - Ceramic patch 2JCP1840104a (2J31) 1595.42 - Ceramic patch 2JCP1840105a (2J32) 1600.42 - Ceramic patch 2JCP1840106a (2J33)
Passive Gain (dBi)	~3.6
Impedance (Ohm)	50
Radiation Pattern	Hemispherical
Polarisation	RHCP

2JDK0201a-C104N

GPS/QZSS/Galileo/L1

Key Features ✓ Development Kit for GNSS ✓ Set of 6 patches to try on devices ✓ High Gain ✓ Patches 25 × 25 × 4 mm

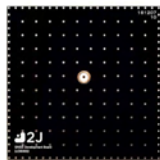

General specification

Mounting type	Thru-Hole mount Ceramic
Dimensions (mm)	25 × 25 × 4 (Patches) 70.4 × 70.4 × 13.5 (Board)
Operating temperature	-40 °C to +85 °C

Antenna and electrical specifications GPS/QZSS/Galileo/L1

Standards	GPS(L1)/QZSS(L1)/Galileo(E1)
Frequency (MHz)	1575.42 - Ceramic patch 2JCP2540101a (2J34) 1580.42 - Ceramic patch 2JCP2540102a (2J35) 1585.42 - Ceramic patch 2JCP2540103a (2J36) 1590.42 - Ceramic patch 2JCP2540104a (2J37) 1595.42 - Ceramic patch 2JCP2540105a (2J38) 1600.42 - Ceramic patch 2JCP2540106a (2J39)
Passive Gain (dBi)	~3.9
Impedance (Ohm)	50
Radiation Pattern	Hemispherical
Polarisation	RHCP

2JDK0101Ga-C104N

GPS/GLONASS/QZSS/Galileo/L1

Key Features ✓ Development Kit for GNSS ✓ Set of 6 patches to try on devices ✓ High Gain ✓ Patches 18 × 18 × 4 mm

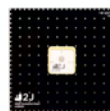
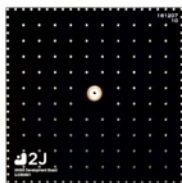

General specification

Mounting type	Thru-Hole mount Ceramic
Dimensions (mm)	18 × 18 × 4 (Patches) 70.4 × 70.4 × 13.5 (Board)
Operating temperature	-40 °C to +85 °C

Antenna and electrical specifications GPS/GLONASS/QZSS/Galileo/L1

Standards	GPS(L1)/GLONASS(L10F)/QZSS(L1)/Galileo(E1)
Frequency (MHz)	1575.42, 1598-1606 - Ceramic patch 2JCP1840101Ga (2J78) 1580.42, 1603-1611 - Ceramic patch 2JCP1840102Ga (2J79) 1585.42, 1608-1616 - Ceramic patch 2JCP1840103Ga (2J80) 1590.42, 1613-1621 - Ceramic patch 2JCP1840104Ga (2J81) 1595.42, 1618-1626 - Ceramic patch 2JCP1840105Ga (2J82) 1600.42, 1623-1631 - Ceramic patch 2JCP1840106Ga (2J83)
Passive Gain (dBi)	~4.1, ~4.2
Impedance (Ohm)	50
Radiation Pattern	Hemispherical
Polarisation	RHCP

2JDK0201Ga-C104N

GPS/GLONASS/QZSS/Galileo/L1

Key Features Development Kit for GNSS Set of 6 patches to try on devices High Gain Patches 25 × 25 × 4 mm

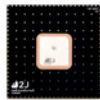
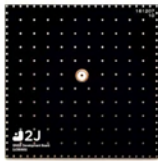

General specification

Mounting type	Thru-Hole mount Ceramic
Dimensions (mm)	25 × 25 × 4 (Patches) 70.4 × 70.4 × 13.5 (Board)
Operating temperature	-40 °C to +85 °C

Antenna and electrical specifications GPS/GLONASS/QZSS/Galileo/L1

Standards	GPS(L1)/GLONASS(L10F)/QZSS(L1)/Galileo(E1)
Frequency (MHz)	1575.42, 1598-1606 - Ceramic patch 2JCP2540101Ga (2J40) 1580.42, 1603-1611 - Ceramic patch 2JCP2540102Ga (2J41) 1585.42, 1608-1616 - Ceramic patch 2JCP2540103Ga (2J42) 1590.42, 1613-1621 - Ceramic patch 2JCP2540104Ga (2J43) 1595.42, 1618-1626 - Ceramic patch 2JCP2540105Ga (2J44) 1600.42, 1623-1631 - Ceramic patch 2JCP2540106Ga (2J45)
Passive Gain (dBi)	~3.6, ~3.9
Impedance (Ohm)	50
Radiation Pattern	Hemispherical
Polarisation	RHCP

2JDK0401Ga-C104N

GPS/GLONASS/QZSS/Galileo/L1

Key Features Development Kit for GNSS Set of 6 patches to try on devices High Gain Patches 13 × 13 × 4 mm

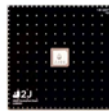
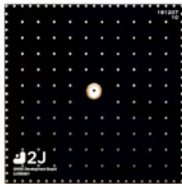

General specification

Mounting type	Thru-Hole mount Ceramic
Dimensions (mm)	13 × 13 × 4 (Patches) 70.4 × 70.4 × 13.5 (Board)
Operating temperature	-40 °C to +85 °C

Antenna and electrical specifications GPS/GLONASS/QZSS/Galileo/L1

Standards	GPS(L1)/GLONASS(L10F)/QZSS(L1)/Galileo(E1)
Frequency (MHz)	1575.42, 1598-1606 - Ceramic patch 2JCP1340101Ga (2J84) 1580.42, 1603-1611 - Ceramic patch 2JCP1340102Ga (2J85) 1585.42, 1608-1616 - Ceramic patch 2JCP1340103Ga (2J86) 1590.42, 1613-1621 - Ceramic patch 2JCP1340104Ga (2J87) 1595.42, 1618-1626 - Ceramic patch 2JCP1340105Ga (2J88) 1600.42, 1623-1631 - Ceramic patch 2JCP1340106Ga (2J89)
Passive Gain (dBi)	~3.5, ~3.1
Impedance (Ohm)	50
Radiation Pattern	Hemispherical
Polarisation	RHCP

2JDK0101Ca

GPS/GLONASS/BEIDOU/QZSS/Galileo/L1

Key Features Development Kit for GNSS Set of 6 patches to try on devices High Gain Patches 18 × 18 × 4 mm

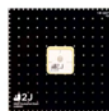
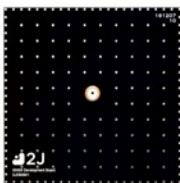

General specification

Mounting type	Thru-Hole mount Ceramic
Dimensions (mm)	18 × 18 × 4 (Patches) 70.4 × 70.4 × 13.5 (Board)
Operating temperature	-40 °C to +85 °C

Antenna and electrical specifications GPS/GLONASS/BEIDOU/QZSS/Galileo/L1

Standards	GPS(L1)/GLONASS(L10F)/BeiDou(B1)/QZSS(L1)/Galileo(E1)
Frequency (MHz)	1561.098, 1575.42, 1598-1606 - Ceramic patch 2JCP1840101Ca (2J116) 1566.098, 1580.42, 1603-1611 - Ceramic patch 2JCP1840102Ca (2J117) 1571.098, 1585.42, 1608-1616 - Ceramic patch 2JCP1840103Ca (2J118) 1576.098, 1590.42, 1613-1621 - Ceramic patch 2JCP1840104Ca (2J119) 1581.098, 1595.42, 1618-1626 - Ceramic patch 2JCP1840105Ca (2J120) 1586.098, 1600.42, 1623-1631 - Ceramic patch 2JCP1840106Ca (2J121)
Passive Gain (dBi)	~5.2, ~5.4, ~5.4
Impedance (Ohm)	50
Radiation Pattern	Hemispherical
Polarisation	RHCP

2JDK0201Ca-C104N GPS/GLONASS/BEIDOU/QZSS/Galileo/L1

Key Features Development Kit for GNSS Set of 6 patches to try on devices High Gain Patches 25 × 25 × 4 mm

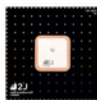
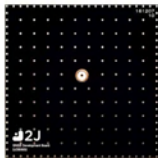

General specification

Mounting type	Thru-Hole mount Ceramic
Dimensions (mm)	25 × 25 × 4 (Patches) 70.4 × 70.4 × 13.5 (Board)
Operating temperature	-40 °C to +85 °C

Antenna and electrical specifications GPS/GLONASS/BEIDOU/QZSS/Galileo/L1

Standards	GPS(L1)/GLONASS(L10F)/BeiDou(B1)/QZSS(L1)/Galileo(E1)
Frequency (MHz)	1561.098, 1575.42, 1598-1606 - Ceramic patch 2JCP2540101Ca (2J61) 1566.098, 1580.42, 1603-1611 - Ceramic patch 2JCP2540102Ca (2J62) 1571.098, 1585.42, 1608-1616 - Ceramic patch 2JCP2540103Ca (2J63) 1576.098, 1590.42, 1613-1621 - Ceramic patch 2JCP2540104Ca (2J64) 1581.098, 1595.42, 1618-1626 - Ceramic patch 2JCP2540105Ca (2J65) 1586.098, 1600.42, 1623-1631 - Ceramic patch 2JCP2540106Ca (2J66)
Passive Gain (dBi)	~4.2, ~4.5, ~5.0
Impedance (Ohm)	50
Radiation Pattern	Hemispherical
Polarisation	RHCP

2JDK0301Ca-C104N GPS/GLONASS/BEIDOU/QZSS/Galileo/L1

Key Features Development Kit for GNSS Set of 6 patches to try on devices High Gain Patches 36 × 36 × 4 mm

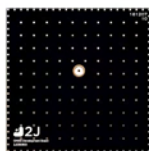

General specification

Mounting type	Thru-Hole mount Ceramic
Dimensions (mm)	36 × 36 × 4 (Patches) 70.4 × 70.4 × 13.5 (Board)
Operating temperature	-40 °C to +85 °C

Antenna and electrical specifications GPS/GLONASS/BEIDOU/QZSS/Galileo/L1

Standards	GPS(L1)/GLONASS(L10F)/BeiDou(B1)/QZSS(L1)/Galileo(E1)
Frequency (MHz)	1561.098, 1575.42, 1598-1606 - Ceramic patch 2JCP3640101Ca (2J46) 1566.098, 1580.42, 1603-1611 - Ceramic patch 2JCP3640102Ca (2J47) 1571.098, 1585.42, 1608-1616 - Ceramic patch 2JCP3640103Ca (2J48) 1576.098, 1590.42, 1613-1621 - Ceramic patch 2JCP3640104Ca (2J49) 1581.098, 1595.42, 1618-1626 - Ceramic patch 2JCP3640105Ca (2J50) 1586.098, 1600.42, 1623-1631 - Ceramic patch 2JCP3640106Ca (2J51)
Passive Gain (dBi)	~4.0, ~3.8, ~4.1
Impedance (Ohm)	50
Radiation Pattern	Hemispherical
Polarisation	RHCP

2JDK0133a-C104N GPS/QZSS/Galileo/L1/IRIDIUM

Key Features Development Kit for GNSS Set of 6 patches to try on devices High Gain Single Feed Technology Patches 25 × 25 × 4 mm

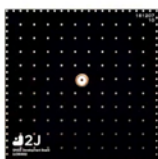

General specification

Mounting type	Thru-Hole mount Ceramic
Dimensions (mm)	25 × 25 × 4 (Patches) 70.4 × 70.4 × 13.5 (Board)
Operating temperature	-40 °C to +85 °C

Antenna and electrical specifications GPS/QZSS/Galileo/L1/IRIDIUM

Standards	GPS(L1)/QZSS(L1)/Galileo(E1), IRIDIUM
Frequency (MHz)	1575.42, 1616-1627 - Ceramic patch 2JCP2543301a (2J128) 1580.42, 1621-1632 - Ceramic patch 2JCP2543302a (2J129) 1585.42, 1626-1637 - Ceramic patch 2JCP2543303a (2J130) 1590.42, 1631-1642 - Ceramic patch 2JCP2543304a (2J131) 1595.42, 1636-1647 - Ceramic patch 2JCP2543305a (2J132) 1600.42, 1641-1652 - Ceramic patch 2JCP2543306a (2J133)
Passive Gain (dBi)	~5.1, ~5.7
Impedance (Ohm)	50
Radiation Pattern	Hemispherical
Polarisation	RHCP

2JDK0126a-C104N

IRIDIUM

Key Features ✓ Development Kit for IRIDIUM ✓ Set of 6 patches to try on devices ✓ High Gain ✓ Patches 36 × 36 × 4 mm



General specification

Mounting type	Thru-Hole mount Ceramic
Dimensions (mm)	36 × 36 × 4 (Patches) 70.4 × 70.4 × 13.5 (Board)
Operating temperature	-40 °C to +85 °C

Antenna and electrical specifications IRIDIUM

Standards	IRIDIUM
Frequency (MHz)	1616-1627 - Ceramic patch 2JCP3642601a (2J52) 1621-1632 - Ceramic patch 2JCP3642602a (2J53) 1626-1637 - Ceramic patch 2JCP3642603a (2J54) 1631-1642 - Ceramic patch 2JCP3642604a (2J55) 1636-1647 - Ceramic patch 2JCP3642605a (2J56) 1641-1652 - Ceramic patch 2JCP3642606a (2J57)
Passive Gain (dBi)	~4.5
Impedance (Ohm)	50
Radiation Pattern	Hemispherical
Polarisation	RHCP

2JDK0226a-C104N

IRIDIUM

Key Features ✓ Development Kit for IRIDIUM ✓ Set of 6 patches to try on devices ✓ High Gain ✓ Patches 25 × 25 × 4 mm



General specification

Mounting type	Thru-Hole mount Ceramic
Dimensions (mm)	25 × 25 × 4 (Patches) 70.4 × 70.4 × 13.5 (Board)
Operating temperature	-40 °C to +85 °C

Antenna and electrical specifications IRIDIUM

Standards	IRIDIUM
Frequency (MHz)	1616-1627 - Ceramic patch 2JCP2542601a (2J90) 1621-1632 - Ceramic patch 2JCP2542602a (2J91) 1626-1637 - Ceramic patch 2JCP2542603a (2J92) 1631-1642 - Ceramic patch 2JCP2542604a (2J93) 1636-1647 - Ceramic patch 2JCP2542605a (2J94) 1641-1652 - Ceramic patch 2JCP2542606a (2J95)
Passive Gain (dBi)	~5.1
Impedance (Ohm)	50
Radiation Pattern	Hemispherical
Polarisation	RHCP

2JDB0202-C831G 4GLTE/FirstNet/LPWA/NB-IoT/3G/2G

Key Features ✓ Flange SMA-Female Board Connector ✓ Ground Plane of 115x45 mm ✓ for Connector Mount Antennas

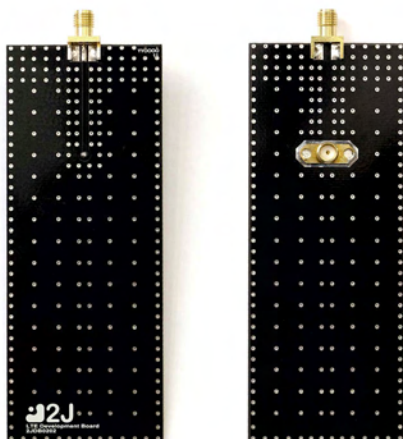

General specification

Mounting type	Connector mount
Dimensions (mm)	124.89 × 45.41 × 13.81
Operating temperature	-40 °C to +85 °C
Usage for	4GLTE/FirstNet/LPWA/CAT-X/CAT-Mx/CAT-NBx/ NB-IoT/3G/Cellular/HSPA/UMTS/WCDA/EDGE/EGPRS/ GRPS/GSM/CDMA/2G Connector Mount Antennas

Development Board for Connector Mount Antennas

2JDB0203-C831G 3G/2G/CELLULAR

Key Features ✓ Flange SMA-Female Board Connector ✓ Ground Plane of 95x40 mm ✓ for Connector Mount Antennas



General specification

Mounting type	Connector mount
Dimensions (mm)	104.89 × 40.4 × 13.85
Operating temperature	-40 °C to +85 °C
Usage for	3G/Cellular/HSPA/UMTS/WCDA/EDGE/EGPRS/ GRPS/GSM/CDMA/2G Connector Mount Antennas

Development Board for Connector Mount Antennas

2JDB0204-C831G GPS/GLONASS/BEIDOU/QZSS/Galileo/L1

Key Features ✓ Flange SMA-Female Board Connector ✓ Ground Plane of 83x40 mm ✓ for Connector Mount Antennas

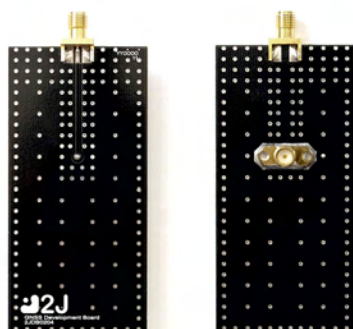

General specification

Mounting type	Connector mount
Dimensions (mm)	92.89 × 40.4 × 13.81
Operating temperature	-40 °C to +85 °C
Usage for	GPS(L1)/GLONASS(L10F)/BeiDou(B1)/ QZSS(L1)/Galileo(E1)

Development Board for Connector Mount Antennas

2JDB0205-C477GB

2.4-5.0GHz/WiFi/LPWA/BT/ISM

- Key Features**
- ✔ Flange SMA-Female Board Connector
 - ✔ Ground Plane of 70x35 mm
 - ✔ for Connector Mount Antennas
 - ✔ RP SMA Female connector for antenna mount
 - ✔ for High Frequency Antennas of 2.4, 3.5 and 5.0 GHz

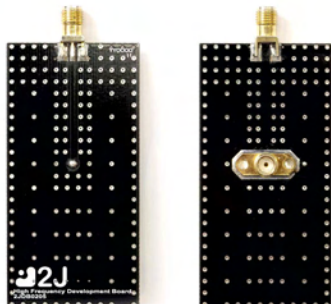

General specification

Mounting type	Connector mount
Dimensions (mm)	79.89 × 35.4 × 13.81
Operating temperature	-40 °C to +85 °C
Usage for	for High Frequency Connector Mount Antennas of 2.4, 3.5 and 5.0 GHz/WiFi/Sigfox/LoRa/LPWA/Bluetooth/BLE/ZigBee/RFID/RFMA/ISM

[Development Board for Connector Mount Antennas](#)

2JDB0201-C831G

380-470MHz/LPWA/TETRA/UHF, 433MHz/LPWA/RFID/ZigBee/ISM, 169MHz/ERMES/VHF

- Key Features**
- ✔ Flange SMA-Female Board Connector
 - ✔ Ground Plane of 150x50 mm
 - ✔ for Connector Mount Antennas
 - ✔ for Low Frequency Antennas

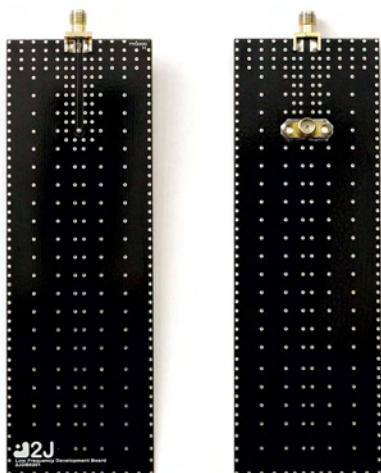

General specification

Mounting type	Connector mount
Dimensions (mm)	159.89 × 50.4 × 13.81
Operating temperature	-40 °C to +85 °C
Usage for	for Low Frequency Connector Mount Antennas/ 433MHz Sigfox/LoRa/RFID/LPWA/ISM/UHF/TETRA/PMR/LMR/169MHz/ERMES/VHF

[Development Board for Connector Mount Antennas](#)

Mounting Brackets



2JB01BW

Screw Mount plastic bracket for 2J94xx and 2J95xx antennas.



White
Black
 Standard colors.
 Other colors upon request.

General specification

Mounting type	Screw mount
Dimensions (mm)	Ø 186 × 72,5
Operating temperature	-40 °C to +85 °C
Material	ASA - UV stable

Features

- Four Screws mounting
- Hidden cable thru the mounting surface
- O-Ring for waterproof solution
- Robust construction
- For all flat surfaces

2JB10BW

Screw Mount plastic bracket for 2J9xxx antennas.



White
Black
 Standard colors.
 Other colors upon request.

General specification

Mounting type	Screw mount
Dimensions (mm)	110 × 65 × 66
Operating temperature	-40 °C to +85 °C
Material	ASA - UV stable

Features

- Screw mount base with four screws M5
- For flat surface mount - no waterproof
- 1-14 UNF thread for antenna mount
- Hidden cable thru the mounting surface

2JB02B

Screw Mount bracket with cable and SMA Female connector.



White
Black
 Standard colors.
 Other colors upon request.

General specification

Mounting type	Screw mount
Dimensions (mm)	Ø 60 × 25
Operating temperature	-40 °C to +85 °C
Material	ASA - UV stable

Features

- Screw mount base
- Equipped with Gasket for flat surface mount
- Suitable for Connector mount antenna
- Hidden cable thru the mounting surface

Note - Equipped with Cable **RG174** or **LL100**

2JB02Ba

Screw Mount bracket with cable and SMA Female connector.



Standard colors.
Other colors upon request.

General specification

Mounting type	Screw mount
Dimensions (mm)	Ø 60 × 25
Operating temperature	-40 °C to +85 °C
Material	ASA - UV stable

Features

- Screw mount base
- Equipped with Gasket for flat surface mount
- Suitable for Connector mount antenna
- Hidden cable thru the mounting surface

Note - Equipped with Cable **D302**

2JB02M

Magnetic Mount bracket with cable and SMA Female connector.



Standard colors.
Other colors upon request.

General specification

Mounting type	Magnetic mount
Dimensions (mm)	Ø 54 × 24
Operating temperature	-40 °C to +85 °C
Material	ASA - UV stable

Features

- Magnetic mount base
- Strong Magnet for Metal surfaces
- For flat surface mount
- Suitable for Connector mount antenna
- Hidden cable thru the mounting surface

Note - Equipped with Cable **RG174** or **LL100**

2JB02Ma

Magnetic Mount bracket with cable and SMA Female connector.



Standard colors.
Other colors upon request.

General specification

Mounting type	Magnetic mount
Dimensions (mm)	Ø 54 × 24
Operating temperature	-40 °C to +85 °C
Material	ASA - UV stable

Features

- Magnetic mount base
- Strong Magnet for Metal surfaces
- For flat surface mount
- Suitable for Connector mount antenna
- Hidden cable thru the mounting surface

Note - Equipped with Cable **D302**

2JB02MP

Magnetic/Adhesive Mount bracket with cable and SMA Female connector.



White
Black
 Standard colors.
 Other colors upon request.

General specification

Mounting type	Magnetic/Adhesive Mount
Dimensions (mm)	Ø 54 × 25
Operating temperature	-40 °C to +85 °C
Material	ASA - UV stable

Features

- Magnetic/Adhesive mount base
- Strong Magnet for Metal surfaces
- For flat surface mount
- Suitable for Connector mount antenna
- Double side adhesive sticker included
- Hidden cable thru the mounting surface

Note - Equipped with Cable **RG174** or **LL100**

2JB02MPa

Magnetic/Adhesive Mount bracket with cable and SMA Female connector.

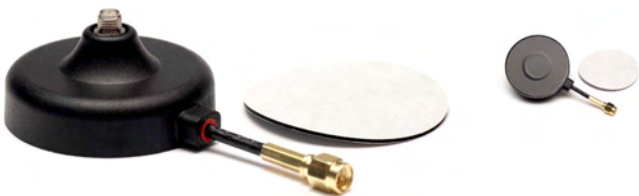

White
Black
 Standard colors.
 Other colors upon request.

General specification

Mounting type	Magnetic/Adhesive Mount
Dimensions (mm)	Ø 54 × 25
Operating temperature	-40 °C to +85 °C
Material	ASA - UV stable

Features

- Magnetic/Adhesive mount base
- Strong Magnet for Metal surfaces
- For flat surface mount
- Suitable for Connector mount antenna
- Double side adhesive sticker included
- Hidden cable thru the mounting surface

Note - Equipped with Cable **D302**

2JB03H

Wall Mount metal bracket for 2J47xx, 2J6Axx, 2J66xx, 2J67xx, 2J75xx, 2J87xx antennas etc.

*Can be used for other screw mount antennas with same screw type.



General specification

Mounting type	Wall Mount
Dimensions (mm)	104 × 90 × 30
Operating temperature	-40 °C to +85 °C
Material	Stainless Steel

Features

- Wall mount bracket
- Strong robust solution
- Stainless Steel Material
- Suitable for Outdoor usage
- For Anti-rotation Antenna mounting

2JB03Ha

Wall Mount metal bracket for 2J47xx, 2J6Axx, 2J66xx, 2J67xx, 2J75xx, 2J87xx antennas etc.
 *Can be used for other screw mount antennas with same screw type.



General specification

Mounting type	Wall Mount
Dimensions (mm)	104 × 90 × 30
Operating temperature	-40 °C to +85 °C
Material	Stainless Steel

Features

- Wall mount bracket
- Strong robust solution
- Stainless Steel Material
- Suitable for Outdoor usage

2JB04H

Wall Mount metal bracket for all antennas equipped with SMA Male connector to be connected onto SMA Female bulkhead connector as opposite.

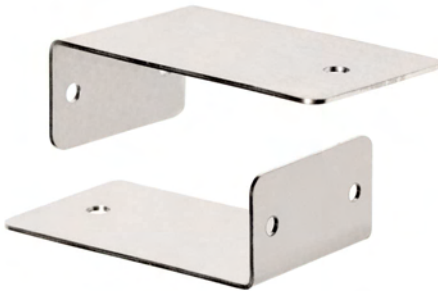

General specification

Mounting type	Wall Mount
Dimensions (mm)	91 × 50 × 31
Operating temperature	-40 °C to +85 °C
Material	Stainless Steel

Features

- Wall mount bracket
- Strong robust solution
- Stainless Steel Material
- Suitable for Outdoor usage

2JB05H

Wall Mount metal bracket for 2J2xxx series antennas except those equipped with N-Connector Female.



General specification

Mounting type	Wall Mount
Dimensions (mm)	155 × 105 × 36
Operating temperature	-40 °C to +85 °C
Material	Stainless Steel

Features

- Wall mount bracket
- Strong robust solution
- Stainless Steel Material
- Suitable for Outdoor usage
- Drilled Holes for cable tie option

2JB06H

Wall Mount metal bracket for 2J2xxx series connector mount antennas equipped with N-Connector Female or antennas equipped with SMA Male connector to be connected onto SMA Female bulkhead connector as opposite.



General specification

Mounting type	Wall Mount
Dimensions (mm)	155 × 105 × 36
Operating temperature	-40 °C to +85 °C
Material	Stainless Steel

Features

- Wall mount bracket
- Strong robust solution
- Stainless Steel Material
- Suitable for Outdoor usage
- Drilled Holes for cable tie option

2JB07H

Wall Mount metal bracket for 2J2xxx series antennas except those equipped with N-Connector Female.



White
 Black
 Standard colors.
 Other colors upon request.

General specification

Mounting type	Wall Mount
Dimensions (mm)	100 × 115 × 30
Operating temperature	-40 °C to +85 °C
Material	ABS - UV stable

Features

- Wall mount bracket
- Strong robust solution
- Suitable for Outdoor usage
- Holes for cable tie option

2JB08H

Wall Mount plastic bracket for 2JDxx antennas or suitable Adhesive Antennas.



White
 Black
 Standard colors.
 Other colors upon request.

General specification

Mounting type	Wall Mount
Dimensions (mm)	100 × 115 × 30
Operating temperature	-40 °C to +85 °C
Material	ABS - UV stable

Features

- Wall mount bracket
- Strong robust solution
- Suitable for Outdoor usage
- Holes for cable tie option

2JB03J

Wall Mount metal bracket for 2J47xx, 2J6Axx, 2J66xx, 2J67xx, 2J75xx, 2J87xx antennas etc.
 *Can be used for other screw mount antennas with same screw type.



General specification

Mounting type	Pole Mount
Dimensions (mm)	112 x 90 x 30
Operating temperature	-40 °C to +85 °C
Material	Stainless Steel

Features

- Pole mount bracket
- Strong robust solution
- Stainless Steel Material
- Suitable for Outdoor usage
- For Anti-rotation Antenna mounting

2JB03Ja

Wall Mount metal bracket for 2J47xx, 2J6Axx, 2J66xx, 2J67xx, 2J75xx, 2J87xx antennas etc.
 *Can be used for other screw mount antennas with same screw type.



General specification

Mounting type	Pole Mount
Dimensions (mm)	112 x 90 x 30
Operating temperature	-40 °C to +85 °C
Material	Stainless Steel

Features

- Pole mount bracket
- Strong robust solution
- Stainless Steel Material
- Suitable for Outdoor usage

2JB09J

Pole Mount metal bracket for 2JWifi12 antenna.



General specification

Mounting type	Pole Mount
Dimensions (mm)	85 x 75 x 87
Operating temperature	-40 °C to +85 °C
Material	Stainless Steel
Max Pole Diameter (mm)	Ø 43

Features

- Pole mount bracket
- Strong robust solution
- Stainless Steel Material
- Suitable for Outdoor usage
- Tilttable in 36° up and 36° down vertically

2JB11JW

Pole Mount plastic bracket for 2J9xxx series antennas with 1 cable.



White
Black
 Standard colors.
 Other colors upon request.

General specification

Mounting type	Pole Mount
Dimensions (mm)	Ø 70.6 × 46
Operating temperature	-40 °C to +85 °C
Material	ASA - UV stable
Mounting Type	For 1-14 UNF mounting type

Features

- Pole mount base
- For 1-14 UNF mounting type
- Suitable for Outdoor usage
- Mostly for Marine applications
- Cable exit through mounting hole

2JB11JWa

Pole Mount plastic bracket for 2J9xxx series antennas with 2 cables.



White
Black
 Standard colors.
 Other colors upon request.

General specification

Mounting type	Pole Mount
Dimensions (mm)	Ø 70.6 × 46
Operating temperature	-40 °C to +85 °C
Material	ASA - UV stable
Mounting Type	For 1-14 UNF mounting type

Features

- Pole mount base
- For 1-14 UNF mounting type
- Suitable for Outdoor usage
- Mostly for Marine applications
- Cable exit through mounting hole

2JB12JW

Pole Mount plastic bracket for 2J9xxx series antennas with 1 cable.

Cable exit through side slot.



White
Black
 Standard colors.
 Other colors upon request.

General specification

Mounting type	Pole Mount
Dimensions (mm)	Ø 70.6 × 56
Operating temperature	-40 °C to +85 °C
Material	ASA - UV stable
Mounting Type	For 1-14 UNF mounting type

Features

- Pole mount base
- For 1-14 UNF mounting type
- Suitable for Outdoor usage
- Mostly for Marine applications
- Cable exit through side slot

2JB12JWa

Pole Mount plastic bracket for 2J9xxx series antennas with 2 cables.
Cable exit through side slot.



Standard colors.
Other colors upon request.

General specification

Mounting type	Pole Mount
Dimensions (mm)	Ø 70,6 × 56
Operating temperature	-40 °C to +85 °C
Material	ASA - UV stable
Mounting Type	For 1-14 UNF mounting type

Features

- Pole mount base
- For 1-14 UNF mounting type
- Suitable for Outdoor usage
- Mostly for Marine applications
- Cable exit through side slot

Cable Assemblies & Connectors

Example of connectors



Example of cable assemblies



Standard connectors and cable types

SMA-Male
SMA-Female
SMA-Male R/A
SMA-Female R/A
SMA-Male RP
SMA-Female RP
SMA-Male RP R/A
SMA-Female Bulkhead
FME-Male
FME-Female
FME-Male Bulkhead
FME-Female R/A
MCX-Male
MCX-Female
MCX-Male R/A
MCX-Female R/A
MMCX
F-Male
F-Female
N-Male
N-Female
N-Female Bulkhead
SMB-Male
SMB-Female
SMB-Female B/H
SMB-Female R/A
TNC-Male
TNC-Female
TNC-Male RP
TNC-Female Bulkhead
SMC-Male
SMC-Female
SMC-Male R/A
SMC-Female Bulkhead
BNC-Male
BNC-Female
FAKRA all types
QMA
CRC9 (TS5)
U.FL / H.FL / W.FL
IPEX MHF 4
GSC



RG174
RX174
RG174HF
RG174LL
RG174TWIN
RG178
RG223
RG316
RG58
RG6
LL100
LL195
Enviroflex 316 D
H155
D100
D302
Microcoax 0.81
Microcoax 1.13
Microcoax 1.32
Microcoax 1.37



SMA-Male
SMA-Female
SMA-Male R/A
SMA-Female R/A
SMA-Male RP
SMA-Female RP
SMA-Male RP R/A
SMA-Female Bulkhead
FME-Male
FME-Female
FME-Male Bulkhead
FME-Female R/A
MCX-Male
MCX-Female
MCX-Male R/A
MCX-Female R/A
MMCX
F-Male
F-Female
N-Male
N-Female
N-Female Bulkhead
SMB-Male
SMB-Female
SMB-Female B/H
SMB-Female R/A
TNC-Male
TNC-Female
TNC-Male RP
TNC-Female Bulkhead
SMC-Male
SMC-Female
SMC-Male R/A
SMC-Female Bulkhead
BNC-Male
BNC-Female
FAKRA all types
QMA
CRC9 (TS5)
U.FL / H.FL / W.FL
IPEX MHF 4
GSC

Specific cable assembly available as per request. Please contact our sales support.

**2J Antennas reserves all rights
to this document and the information contained herein.**

Data shown in this document are subject to change without notice and do not constitute
a binding guarantee of product performance, parameters or services.

created by | 

2J Antennas



2J USA

2JANTENNAS USA, CORP.

5744 Pacific Center Blvd, Suite 311
San Diego, CA 92121, **USA**

☎ +1 (858) 465-6262

✉ ussales@2j-antennas.com

🌐 www.2j-antennas.com

2J UK

2JANTENNAS UK, LTD.

7 The Briars, Waterberry Drive
Waterlooville, Hampshire, PO7 7YH, **UK**

☎ +44 (2394) 001-023

✉ uksales@2j-antennas.com

🌐 www.2j-antennas.com

2J SVK (HQ)

2J ANTENNAS, S.R.O.

Stefanikova 61
085 01, Bardejov, **Slovakia**

☎ +421 (54) 488-0130

✉ sales@2j-antennas.com

🌐 www.2j-antennas.com